

Clippard

PRECISION FLOW CONTROL

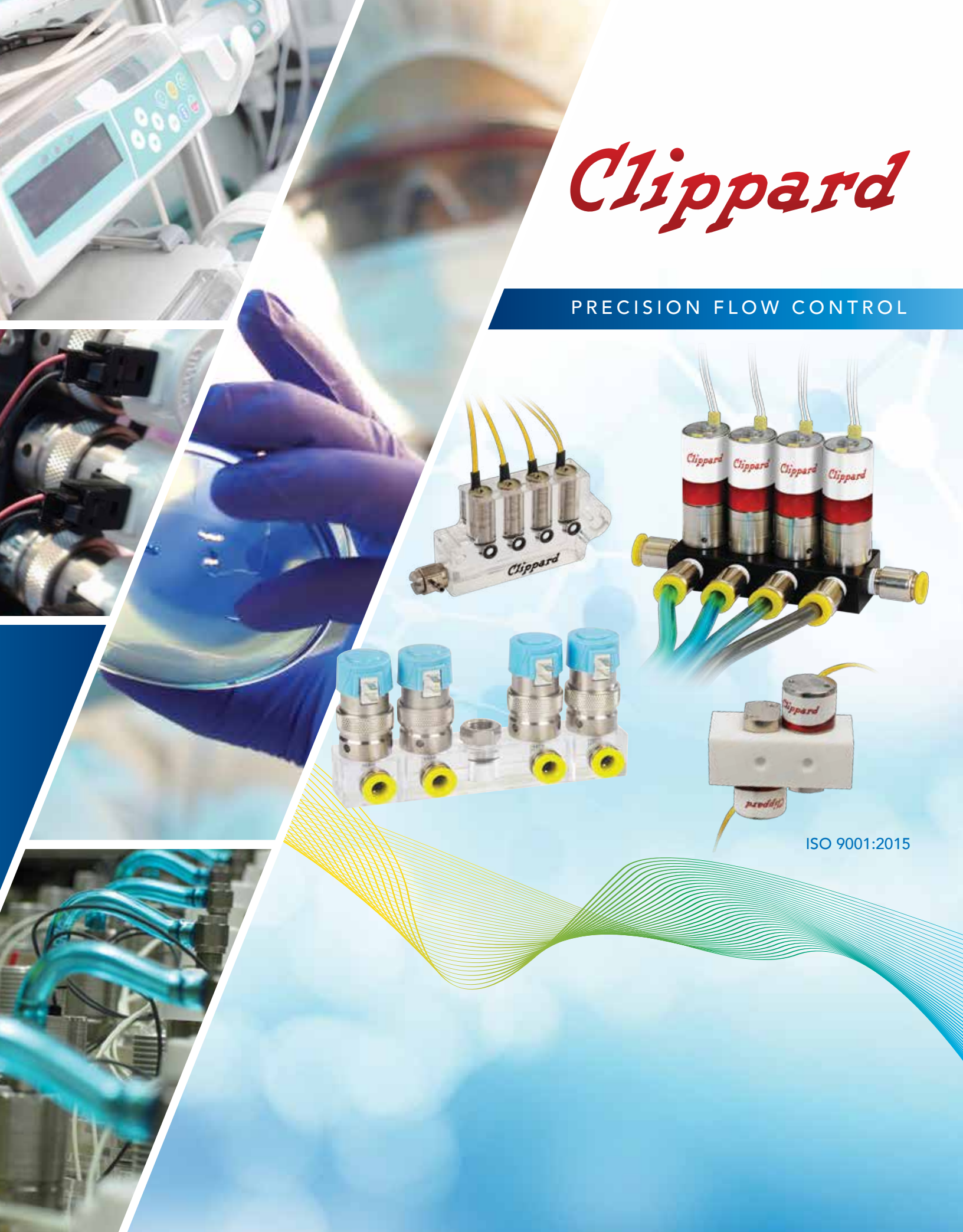

ISO 9001:2015

Clippard

Clippard is a third-generation family-owned and operated company. We have been proudly manufacturing in the United States of America for more than 75 years. Although many things have changed since our founder Leonard Clippard first began making coils out of his home in 1941, the fundamental principles he instilled in his company have endured. Our motto "Quality People, Quality Products" emphasizes the importance we place on relationships. Putting people over products was important to Leonard and it's a philosophy that remains deeply embedded in our company culture. This extends not just to our employees but to our customers, our distributors, our suppliers, and our community.

It is this unique culture that has allowed us to rise above our competition—a culture rooted deeply in our company's rich history, strengthened by our values, and cultivated by the efforts of many dedicated people over the years. Though it may be difficult to describe, it is unmistakably felt. Let us show you what it means to work with Clippard.



To learn more about Clippard's history, visit clippard.com/link/history

Our Credo

We are engaged in honorable work, providing the world with useful, productive, affordable products.

We do this with the distinction of a long reputation for quality, service, performance, and value.

We deal fairly. We keep our word.

We understand profit is a vehicle to our purposes and not our only purpose.

We support our community.

We enjoy what we do. We are good at it.

We are getting better all the time.

We are grateful to God for our blessings.

We respect and encourage each other.

We show pride in our work.

We are Clippard.

Table of Contents

ELECTRONIC VALVES.....pp. 2-51

EV Series, pp. 4-17 *Electronic Manifold Cards, p. 21* *DV Series, pp. 32-34*
ECN, ETN, EVN Valves, p. 18 *EM Series, p. 22* *EFB Series, p. 36*
Intrinsically Safe Valves, p. 19 *ES & ESO Series, pp. 23-26* *10 & 15 mm Valves, pp. 39-44*
Manifolds & Connectors, p. 20 *7 & 8 mm Valves, pp. 29-30* *Maximatic® Valves, pp. 46-51*

PROPORTIONAL VALVES.....pp. 52-65

EVP Series, pp. 54-57 *SCPV Series, pp. 60-61*
DVP Series, pp. 58-59 *Proportional Isolation Valves, p. 62*

ISOLATION VALVES.....pp. 66-71

Media Isolation Valves, p. 68
Gradient Mixing Valves, p. 69
Pinch Valves, pp. 70-71

DIRECTIONAL CONTROL VALVES.....pp. 72-93

Toggle Valves, pp. 78-84 *Actuators, pp. 89-92*
Stem Valves, pp. 85-88 *Manually-Operated Valves, p. 93*
Sleeve & Limit Valves, p. 89

AIR PILOT VALVES.....pp. 94-113

Low Pressure Valves, pp. 96-97
Maximatic® Valves, pp. 99-101
Modular Valves, pp. 102-113

CONTROL VALVES.....pp. 114-129

Check Valves, p. 116 *Volume Chambers, p. 121* *Shuttle Valves, p. 127*
Exhaust Valves, p. 117 *Mufflers, p. 121* *Sensors & Air Indicators, p. 128*
Flow Controls, pp. 118-120 *Needle Valves, pp. 122-123* *Switches, p. 129*
Gauges & Air Chokes, p. 121 *Pressure Regulators, pp. 124-126* *Water Drawback Valves, p. 129*

CYLINDERS.....pp. 130-167

Options & Types, pp. 132-133 *Corrosion-Resistant, pp. 152-155* *Accessories, pp. 164-165*
Force Factors, p. 135 *Compact Extruded, pp. 156-159* *Position Sensors, pp. 166-167*
Stainless Steel, pp. 136-147 *Brass, pp. 160-162*
All Stainless Steel, pp. 148-151 *Air Volume Tanks, p. 163*

AIR PREPARATION EQUIPMENT.....pp. 168-179

FRLs, pp. 170-174 *Regulators & Lubricators, p. 176* *Accessories, pp. 177-179*
Filters, p. 175 *Shut-Off/Lock Out Valves, p. 177*

FITTINGS & TUBING.....pp. 180-189

Minimatic® Fittings, pp. 182-185 *Accessories, p. 188*
Push-Quick Fittings, pp. 186-187 *Tubing, p. 189*

ELECTRONIC VALVES	2
PROPORTIONAL VALVES	52
ISOLATION VALVES	66
DIRECTIONAL CONTROL VALVES	72
AIR PILOT VALVES	94
CONTROL VALVES	114
CYLINDERS	130
AIR PREPARATION EQUIPMENT	168
FITTINGS & TUBING	180

Cleaning Capabilities...pp. 8-9

Custom Solutions...p. 12

Solenoid Valve Overvoltage...p. 27

Leak Detection...p. 28

Hit & Hold Circuits...p. 38

What Is Hysteresis?...p. 63

Special Materials...pp. 64-65

Cylinder Cushions...p. 134

Index...pp. 190-192

Electronic Valves



EV SERIES

- Industry standard for leak-free operation
- Quiet operation and fast response
- Low power consumption
- Exceptionally long life

pp. 4-21



EM SERIES

- Fast response
- Low power consumption
- Close mounting—less than 3/4" in diameter

p. 22



ES SERIES

- Close mounting—less than 1" tall and only 7/8" on center
- Compact, geometric design allows for easy mounting

pp. 23-26



EFB SERIES

- Compact, robust design
- Multiple flow and pressure options
- Variety of power and connection options

p. 36



10 & 15 MM VALVES

- 2-Way or 3-Way operation
- Variety of circuit features, manifold options and connectors
- Detachable coil and body

pp. 39-44



MAXIMATIC® SERIES

- 2-Way, 3-Way and 4-Way operation
- Maximum value, maximum performance
- Manifold or in-line mounting

pp. 46-51



7 MM VALVES

- Extremely small dead volume
- Low vibration and noise
- Fast response time
- Low power consumption

p. 29



8 MM VALVES

- Extremely small dead volume
- Low vibration and noise
- Fast response time
- Low power consumption

p. 30



DV SERIES

- Designed to accommodate large flows with more stroke
- Fast response time
- Low heat rise
- Low power consumption

pp. 32-34



CUSTOM VALVES

- Custom voltage, connections, flow rates, materials and more
- Complete integrated solutions

p. 12

CLEANING CAPABILITIES pp. 8-9

CUSTOM SOLUTIONS p. 12

SOLENOID VALVE OVERVOLTAGE p. 27

LEAK DETECTION p. 28

HIT & HOLD CIRCUITS p. 38

Many items also available with metric ports.
For more information, visit clippard.com/link/metric

ORIGINAL EV SERIES MOUSE VALVES

2-WAY & 3-WAY, N.O. OR N.C. VALVES



Valve Type	2-Way or 3-Way, N.O. or N.C.
Medium	Clean, dry air (40 micron filter)
Pressure Range	Vac. to 105 psig
Nominal Power	0.67 watts
Response Time	5 to 10 ms
Temperature Range	32 to 180°F
Operating Range	90 to 150% of rated voltage
Voltage	12 VDC or 24 VDC
Mounting	In-line or manifold mount
Materials	Nickel-plated brass body; nickel-plated steel housing, core, and spider
Seal Material	Nitrile standard, FKM, EPDM ¹ and silicone ¹ available
More Details	clippard.com/link/ev

¹Minimum order quantity for EPDM or silicone seals

Clippard's original EV series valve design is a deceptively simple arrangement featuring a remarkably quiet, low power operation. The Clippard "spider" is the only moving part, and its motion to operate the valve is a mere 0.007" travel. As a result, this valve features an exceptionally long life—proven to last over 1,000,000,000+ cycles. Low voltage DC inputs move the spider, generating extremely fast response times of 5 to 10 milliseconds while using only 0.67 watts of power. The EV series is cool running and its compact, lightweight design makes it easy to mount in small spaces.

- 1,000,000,000+ cycle life
- Low vibration and noise
- 100% tested
- Low power
- Fast response time
- Compact and lightweight



Also available in Analytical,
Corrosion-Resistant, Oxygen Clean,
& Proportional versions

QUICK CONNECT

Clippard ET valves feature spade lugs for simple, quick secure low voltage connections. Wire crimp-on spade lug connectors are available separately to adapt electronic wiring where necessary. Clippard original EV type valves are available in popular voltages with 18" wire leads. The EC model utilizes a 0.025" square pin connector.



EASY MOUNTING

The complete line of EC, EV, ET and EW electronic valves are available with two mounting options. In-line base models have two #6-32 threaded, 7/32" deep mounting holes. Manifold models are equipped with a bottom stud, 5/32" long with #10-32 thread, which fits Clippard standard and special manifolds, accessory valves and subplates. Spanner holes in the valve body permit tightening.

Clippard's Best-Selling EV Series Electronic Valve

Clippard EV series electronic valves are quiet and quick. These valves accept low voltage, low current signals and convert them into high pressure (100 psig) pneumatic outputs. Optional low pressure/medium flow (-L) and low pressure/high flow (-H) are available.

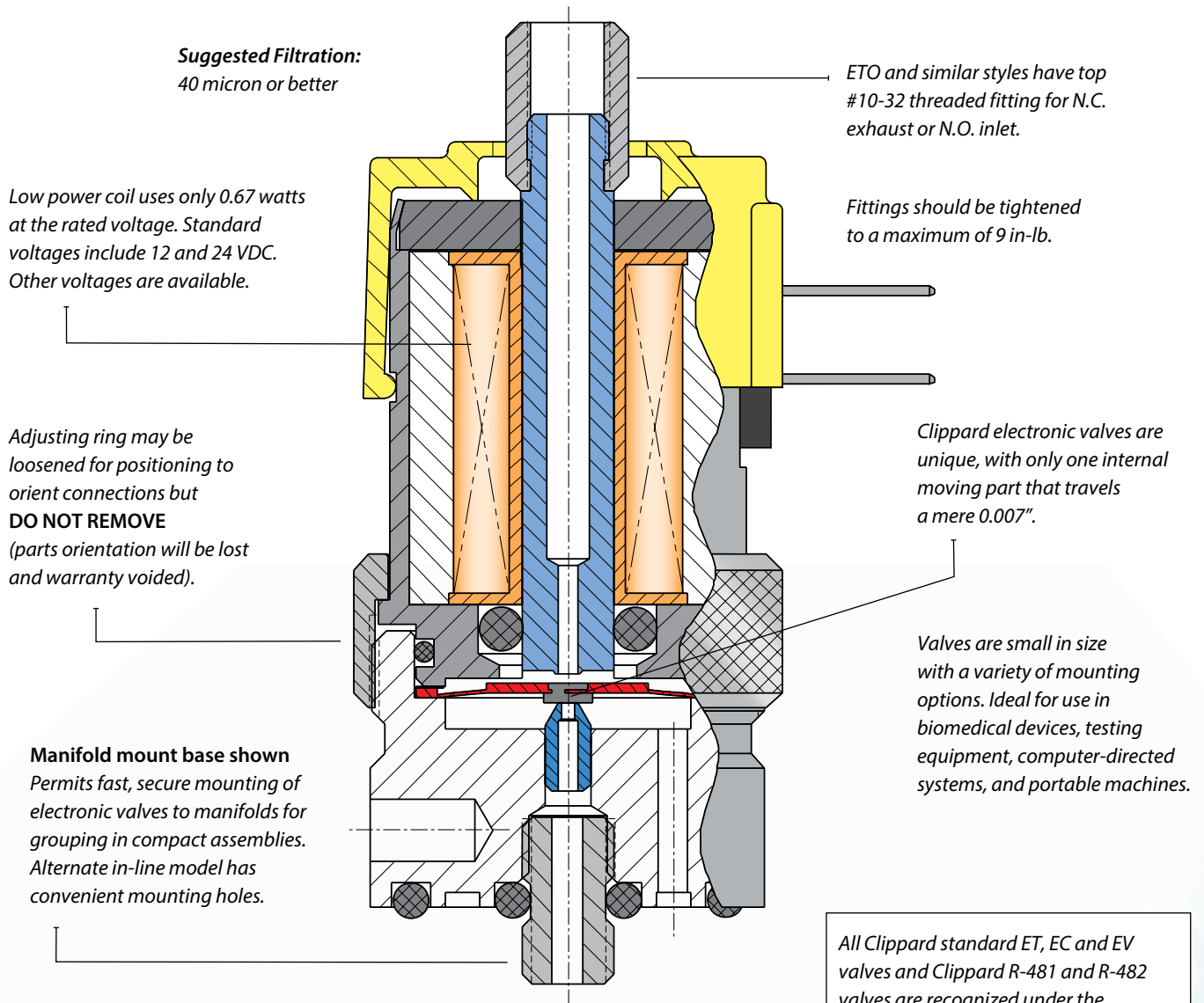

All Clippard standard ET, EC and EV valves and Clippard R-481 and R-482 valves are recognized under the Component Program of Underwriters Laboratories, Inc.

File No. MH 13573



Clippard Minimatic electronic valves are precision-built 2-Way or 3-Way control valves, utilizing a unique, patented, valving principle. There are no sliding parts. Complete poppet travel is a mere 0.007". As a result, low power consumption and exceptionally long life are major benefits of this design.

Clippard EV series valves are very quiet in operation and also very cool. The small, compact size of these valves make them well suited for a wide range of applications in biomedical devices, environmental test equipment, textile machines, packaging machinery, computerized industrial automation, and portable systems.

ORIGINAL EV SERIES MOUSE VALVES



STANDARD SERIES

2-Way and 3-Way manifold and in-line mounting. Normally-Closed and fully-ported versions.

HIGH FLOW VERSION

A higher flow version is also available for 2-Way, Normally-Closed applications. Although manifold mounting is accomplished in the same fashion, the inlet is the annular port, and the outlet becomes the center port, through the convenient stud mount of the valve.

More Details: clippard.com/link/ev

Nickel-plated brass fitting

Electroless nickel-plated steel housing and core

Nitrile seals standard

Electroless nickel-plated brass body

Stainless steel stud and nozzle

(Manifold style valve shown)

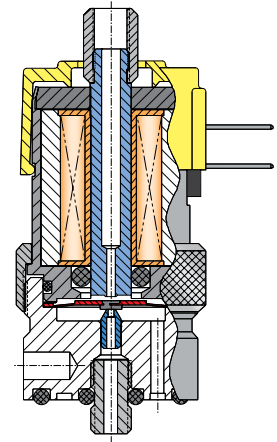

CORROSION-RESISTANT SERIES

Clippard's Corrosion-Resistant Series (CR-) incorporates materials and construction that provides enhanced protection for valves used with mildly corrosive media such as moisture in air or gases. Where stainless steel is not possible, plating is incorporated to add life to wear components. A nickel-plated brass valve body is standard, but stainless steel may be substituted.

More Details: clippard.com/link/cr-ev

Nickel-plated brass fitting

Stainless steel housing and core

Nitrile seals standard

Electroless nickel-plated Spider

(Manifold style valve shown)

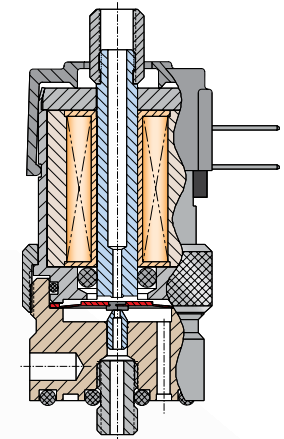

ANALYTICAL SERIES

Clippard's Analytical Valve (A-) series combines the proven features of the "Mouse" series with the specific needs of the analytical industry, and for applications where cleanliness is especially important. Special materials, manufacturing and assembly processes make this valve perfectly suited for applications where internal cleanliness, bubble-tight operation, and long life are imperative.

More Details: clippard.com/link/analytical

Integral fitting

No anaerobic sealant used

Larger cross section o-ring improves sealing

Cleaned per Clippard Standard ES-3.43

One-piece base eliminates many leak points

Outgassed FKM seals standard

(Manifold style valve shown)

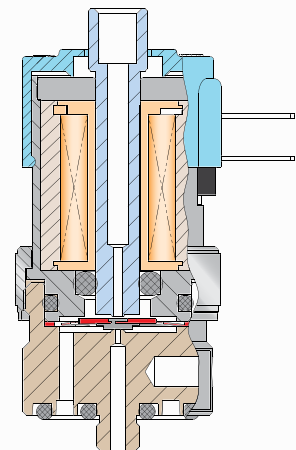

ORIGINAL EV SERIES MOUSE VALVES

OXYGEN CLEAN SERIES



All EV, ET, EC and EW series electronic valves with the "O-" part number option are available manufactured and assembled for use in oxygen-enriched environments for applications that are extremely sensitive to contamination.

More Details: clippard.com/link/oxygen

- Valves are ultrasonically cleaned, assembled, inspected and tested in a cleanroom with a state-of-the-art positive pressure HEPA filtration system
- Both organic and inorganic contaminants, such as particulate matter and hydrocarbon oils, are removed
- No organic sealants, adhesives, or lubricants are used in the manufacturing process
- Component parts are lubricated with oxygen-compatible PFPE grease, only as needed for assembly
- Individual testing and inspection is accomplished utilizing compressed Nitrogen and ultra-violet light

Integral fitting

No thread sealant

All wetted parts cleaned per Clippard Standard ES-3.41

Electroless nickel-plated steel housing and core

FKM seals

Stainless steel nozzle

Electroless nickel-plated brass body

Integral stud

PFPE lubricant

(Manifold style valve shown)

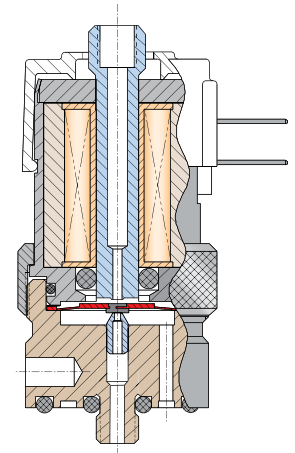

Valves are assembled in Clippard's clean room, which exceeds **ISO 13485** specification for medical devices.

ELECTRONIC VALVES



ECN, EVN, ETN MOUSE VALVES



Normally-Open, manifold mount to allow Normally-Closed and Normally-Open valves on the same manifold.

More Details: clippard.com/link/ecn

Integral fitting

Armature "spider" above coil

Mounts side-by-side with Normally-Closed version

(Manifold style valve shown)

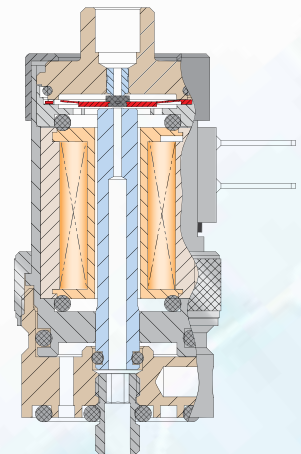

CLEANING CAPABILITIES



It's no surprise that the cleaner your valve is, the less it will leak. However, cleanliness is also important in other ways, such as for medical applications where fluid flowing through the valves may be entering a person's body or for applications in the food and beverage industry. In these cases, the valves must not only be cleaned of any particulate matter, but also of any harmful substances used in the normal machining or assembly process. When cleanliness matters, you can count on Clippard to provide the special cleaning, assembly, and testing processes your demanding applications require.

Each of Clippard's manufacturing facilities are equipped with custom isolation enclosures designed specifically for the pharmacy and biotech industries. These clean rooms provide enclosed, controlled environments for the assembly, inspection, and testing of sensitive valves and equipment. They help to protect against airborne contaminants, ultraviolet rays, and temperature fluctuations. Additionally, the modular nature of these enclosures allows Clippard to quickly and easily expand capacity to meet special requirements or increased demand.

ANALYTICAL SERVICE

Valves intended for low-leak, high precision environments, such as laboratories, often require higher quality cleaning and handling to limit contamination. Clippard's analytical "A-" series electronic valves provide a standard valve that meets these requirements. The assembly standards for these valves can also be applied to customer specials.



- Valves are designed with reduced leak paths
- Valves are ultrasonically cleaned, assembled, inspected, and tested in a clean room area
- Seals are cleaned ultrasonically with high purity alcohol, then heated to outgas before assembly
- Cleaned parts are inspected under white and ultraviolet light to insure the absence of particulate and hydrocarbon contamination
- Components are lubricated with isopropyl alcohol, only as needed for assembly
- Valves are tested using high purity compressed nitrogen in place of standard shop air
- Valves are pressure decay leak tested
- Finished valves are double bagged in heat sealed polyethylene bags to ensure cleanliness

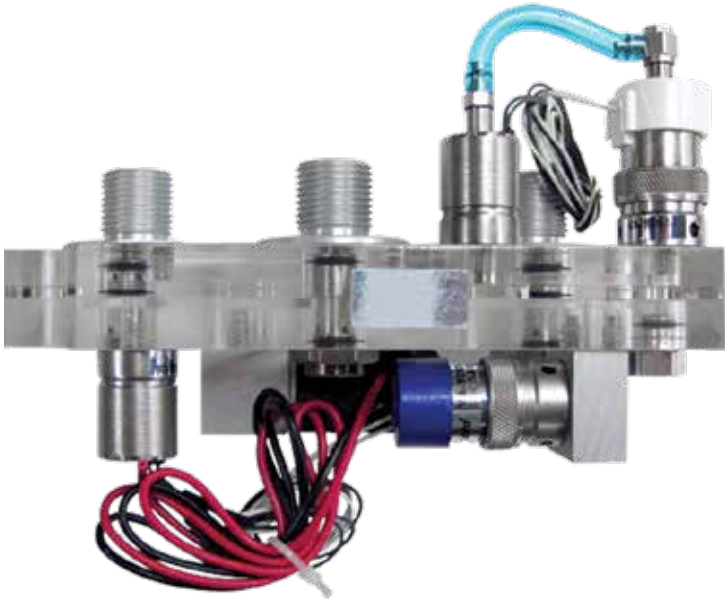

OXYGEN SERVICE

Due to the high flammability of oxygen, parts used in oxygen-rich environments are extremely sensitive to contamination. Clippard has a number of engineering standards in place that dictate strict cleaning requirements for valves rated for oxygen-rich environments. This includes the standard oxygen clean "O-" series of electronic valves, but can also be applied to customer special orders upon request.

Clippard's cleaning standards for oxygen service include the following:

- Valves are ultrasonically cleaned, assembled, inspected, and tested in a clean room area
- Cleaned parts are inspected under white and ultraviolet light to insure the absence of organic and inorganic contaminants, such as particulate and hydrocarbon contamination
- No organic sealants, adhesives, or lubricants are used in the manufacturing process
- Component parts are lubricated with oxygen-compatible PFPE (perfluoropolyether) grease, only as needed for assembly
- Valves are tested using high purity compressed nitrogen
- Finished valves are double bagged in heat sealed polyethylene bags

SPECIAL CLEANING REQUIREMENTS

Do you have an application which requires special cleaning for its manufacture, assembly or testing? Clippard is able to provide a wide range of special cleaning, inspection, and testing options for components or assemblies.

Call **877-245-6247** today to discuss how we can accommodate your unique needs, including:

- Ultrasonic cleaning of component parts
- Baking of seals in order to outgas chemicals
- Inspection of cleaned parts under ultraviolet light to detect oil or fibers
- Inspection of cleaned parts under microscopes
- Use of alternate lubricants/sealants or the exclusion of lubricants/sealants from the assembly process
- Testing using high purity compressed nitrogen in place of standard shop air
- Helium leak testing for ultra low leak requirements
- Special packaging of parts to ensure cleanliness



ORIGINAL EV SERIES MOUSE VALVES

ELECTRICAL CONNECTION OPTIONS & MOUNTING STYLES

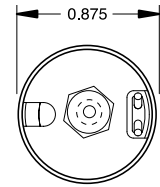
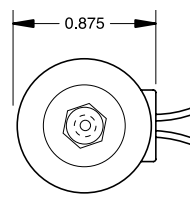
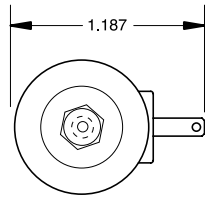
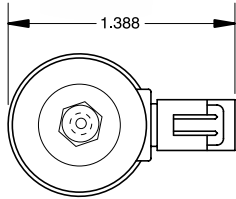
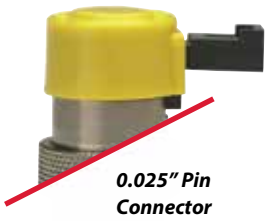

IN-LINE MOUNT

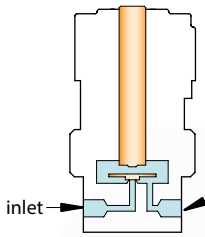

**2-Way
Normally-Closed
In-Line Mount**

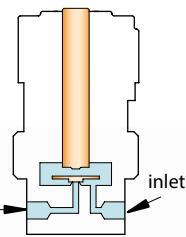

**2-Way
Normally-Closed
High Flow**

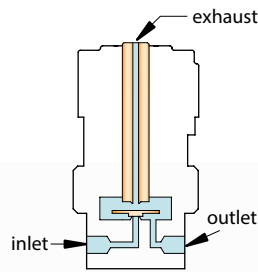

**3-Way
Normally-Closed
In-Line Mount**

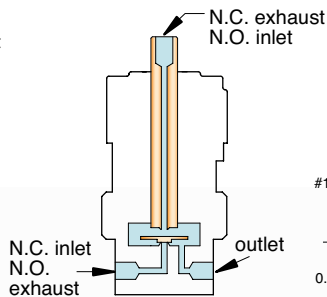

**3-Way
Fully-Ported
In-Line Mount**

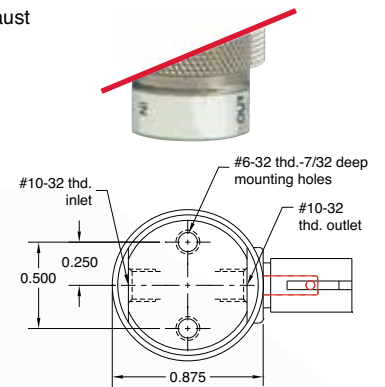

MANIFOLD MOUNT

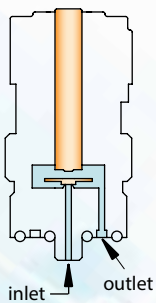

**2-Way
Normally-Closed
Manifold Mount**

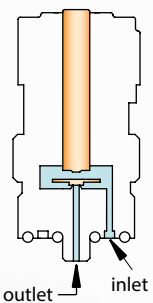

**2-Way
Normally-Closed
High Flow
Manifold Mount**

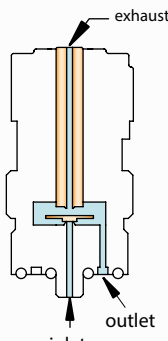

**3-Way
Normally-Closed
Manifold Mount**

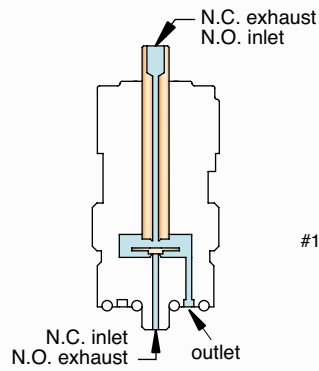

**3-Way
Fully-Ported
Manifold Mount**

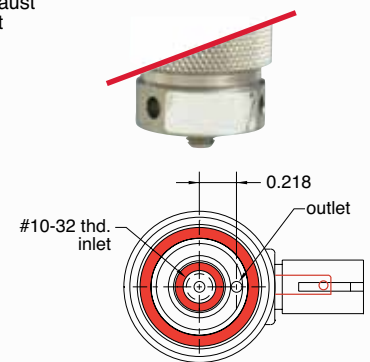

PROBLEM

It's no surprise that the cleaner your valve is, the less it will leak. However, cleanliness is also important for medical applications where fluid flowing through the valves may be entering a person's body. This requires valves to not only be cleaned of any particulate matter, but also of any harmful substances used in the normal machining or assembly process. In this instance, the OEM's primary concern was that their equipment was not consistently meeting the standards they had set for cleanliness. They were also interested in re-designing the unit to make it smaller.



ELECTRONIC VALVES

SOLUTION

Each of Clippard's manufacturing facilities are equipped with custom isolation enclosures for the assembly, inspection, and testing of sensitive valves and equipment. To eliminate the contamination issues the OEM had been experiencing, their system's valves were replaced with Clippard Oxygen Clean Series EV valves. This line conforms to Clippard's rigorous ES-3.41 cleaning specification which includes ultrasonic cleaning as well as special assembly processes, UV inspection, and high purity compressed nitrogen testing. This insures the absence of any organic or inorganic contaminants. Additionally, because Clippard's valves are 100% tested and calibrated, they also served to increase the system's reliability by providing consistent flow rates.

A standard Clippard manifold allowed the new valves to be closely mounted with a small, compact footprint. This freed up additional space within the unit which contributed to the OEM being able to reduce its overall size. Additionally, the OEM was pleasantly surprised to find that the valves—a standard catalog product, manufactured here in the USA—were always available and shipped quickly, thus eliminating the backorder delays they had been experiencing with their previous supplier.



WHAT CAN CLIPPARD DO FOR YOU?

877-245-6247

CUSTOM SOLUTIONS



Clippard understands that often, a standard catalog product may be close but not exactly what your application requires. We frequently provide modifications and custom designs to better suit specific application requirements, and we love a good challenge! Clippard takes great pride in helping customers like you design better products. Smaller, faster, lighter—what are you trying to accomplish? We can help with anything from modified standard products to special manifolds to completely custom products designed for specific, unique applications.

CONNECTING ENGINEERS WITH ENGINEERS

Our sales team and distributors are invaluable, but our engineers don't like having to relay information through other people any more than yours do. Whenever possible, we prefer to get your technical people speaking directly to ours. This enables more efficient communication and has proven to be one of the best ways to shorten project timelines and ensure mutual success.

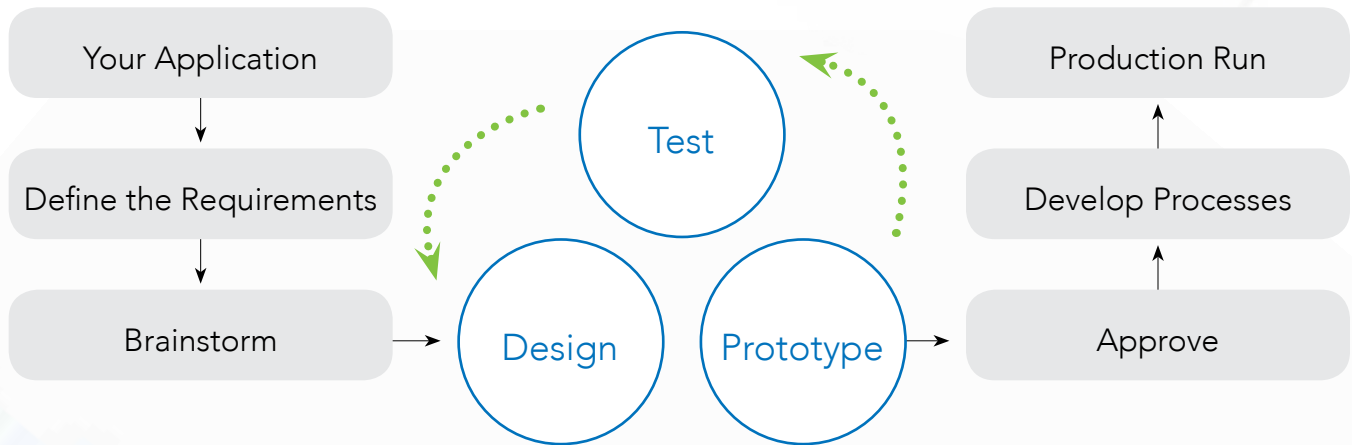

BENEFITS

- 100% tested sub-assemblies
- Less component inventory
- Fewer vendors and purchase orders
- Less manufacturing time
- Increased production efficiency
- Specialized support
- Overall cost reduction

OPTIONS

- Special seal materials
- Flow and pressure ranges
- Voltage and power requirements
- Electrical connections
- Ports and connectors
- Mounting configurations
- Oxygen service applications
- Pressure decay testing and helium leak detection

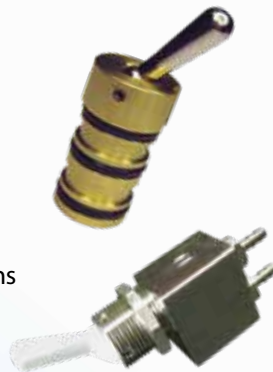

CAPABILITIES

- Designing compact, easy-to-install assemblies
- Customizing ports and connectors
- Developing integrated solutions
- Manufacturing special manifolds
- Designing pneumatic circuits
- Integrating control boxes and fitting/tubing harnesses
- Assembling and kitting components
- Performing specialized testing
- Providing KanBan services

ORIGINAL EV SERIES MOUSE VALVES

FLOW CHART & ELECTRICAL SPECIFICATIONS

TYPICAL AIR FLOW

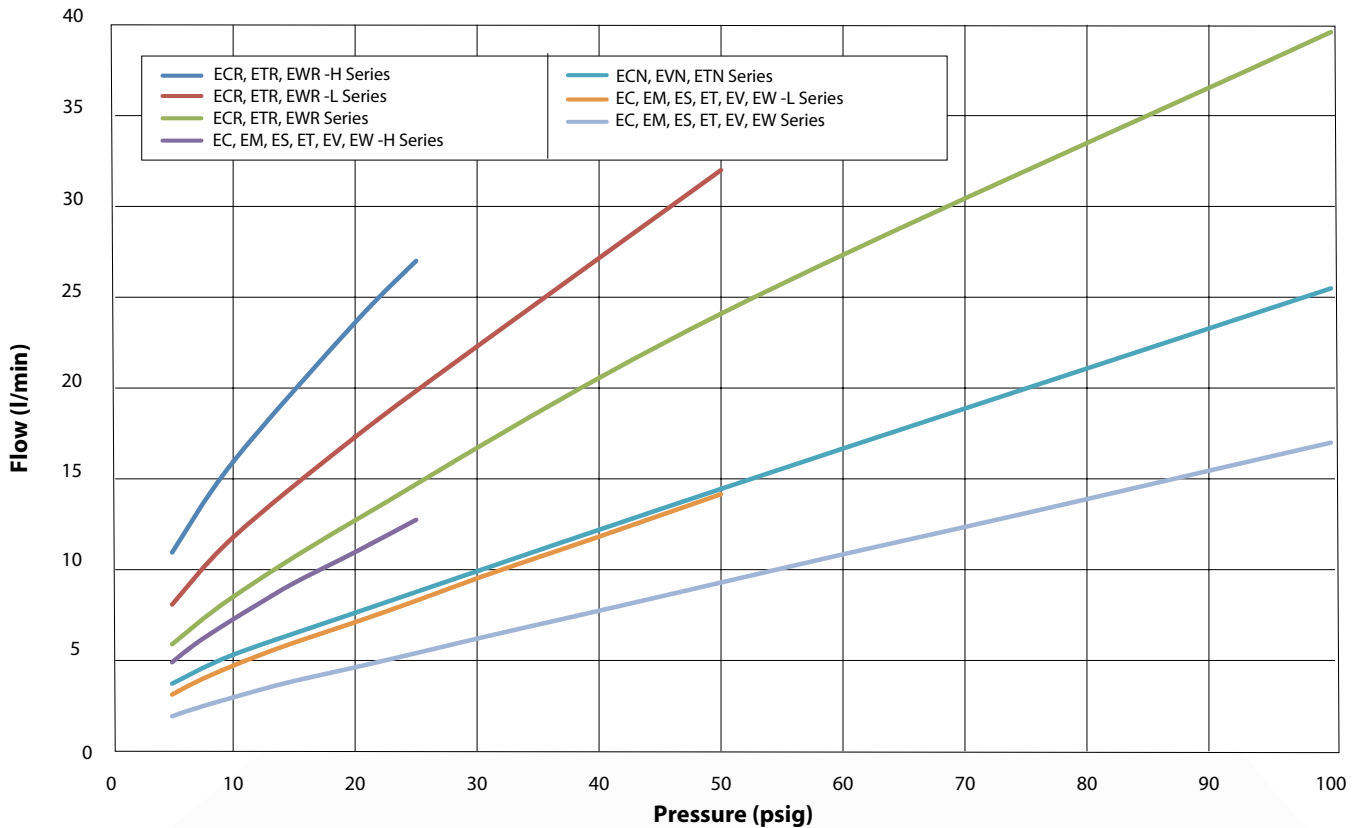

ELECTRONIC VALVES

ELECTRICAL SPECIFICATIONS

Series	Voltage	Nominal Current	Resistance	Power	Working Range
Standard	12 VDC	0.055 amps	218 ohms	0.67 watts	90 to 150% of rated voltage (<i>cont. duty</i>)
Oxygen Clean Analytical	24 VDC	0.028 amps	864 ohms		
Corrosion-Resistant	12 VDC	0.098 amps	122 ohms	1.2 watts	90 to 110% of rated voltage (<i>cont. duty</i>)
	24 VDC	0.049 amps	486 ohms		
EM Series	12 VDC	0.083 amps	144 ohms	1.0 watt	90 to 120% of rated voltage (<i>cont. duty</i>)
ES Series	24 VDC	0.042 amps	576 ohms		

Custom Solutions

Many people shy away from asking for custom products, fearing higher prices and longer lead times. However, the reality may surprise you. Clippard's electronic valve production consists of nearly 50% customized products. From simple tweaks to complex challenges, Clippard excels at providing solutions for a wide range of applications.

Contact your local distributor or call **877-245-6247** today to discuss your specific needs.



ORIGINAL EV SERIES MOUSE VALVES

2-WAY N.C. VALVES, IN-LINE & MANIFOLD MOUNT

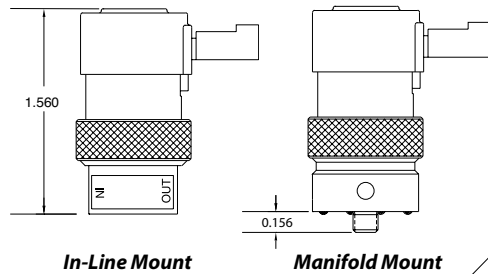

Vac. to 105 psig
 Vac. to 50 psig
 Vac. to 25 psig
 12 VDC
 24 VDC

		Pressure Range			Voltage		In-Line Mount	Manifold Mount
 0.025" Pin Connector	•			•	•	EC-2-12	EC-2M-12	
	•			•	•	EC-2-24	EC-2M-24	
		•		•	•	EC-2-12-L	EC-2M-12-L	
		•		•	•	EC-2-24-L	EC-2M-24-L	
			•	•	•	EC-2-12-H	EC-2M-12-H	
				•	•	EC-2-24-H	EC-2M-24-H	
 Spade Terminals	•			•	•	ET-2-12	ET-2M-12	
	•			•	•	ET-2-24	ET-2M-24	
		•		•	•	ET-2-12-L	ET-2M-12-L	
		•		•	•	ET-2-24-L	ET-2M-24-L	
			•	•	•	ET-2-12-H	ET-2M-12-H	
				•	•	ET-2-24-H	ET-2M-24-H	
 Wire Leads Side (Radial)	•			•	•	EV-2-12	EV-2M-12	
	•			•	•	EV-2-24	EV-2M-24	
		•		•	•	EV-2-12-L	EV-2M-12-L	
		•		•	•	EV-2-24-L	EV-2M-24-L	
			•	•	•	EV-2-12-H	EV-2M-12-H	
				•	•	EV-2-24-H	EV-2M-24-H	
 Wire Leads Top (Axial)	•			•	•	EW-2-12	EW-2M-12	
	•			•	•	EW-2-24	EW-2M-24	
		•		•	•	EW-2-12-L	EW-2M-12-L	
		•		•	•	EW-2-24-L	EW-2M-24-L	
			•	•	•	EW-2-12-H	EW-2M-12-H	
				•	•	EW-2-24-H	EW-2M-24-H	

Medium	Clean, dry air (40 micron filter)
Power Consumption	0.67 watts; Corrosion-Resistant: 1.2 watts
Temperature Range	32 to 180°F; Corrosion-Resistant: 32 to 150°F
Response Time	5 to 10 ms (nominal)
Operating Range	90 to 150% of rated voltage Corrosion-Resistant: 90 to 110%
Ports	#10-32
Seals	Nitrile standard; FKM, EPDM ¹ , and silicone ¹ available Oxygen Clean: FKM only Analytical²: FKM standard; EPDM ¹ , silicone ¹ available
More Details	clippard.com/link/ev

See p. 10 for mounting option schematics

Valve Series Prefix	Options Suffix
Oxygen Clean	O- Nitrile Seals ³ (blank)
Analytical ²	A- FKM Seals -V
Corrosion-Resistant	CR- EPDM Seals ^{1,3} -E
	Silicone Seals ¹ -S
	Diode ⁴ -D

Pressure Range	Air Flow	Options Suffix
28" Hg Vac. to 105 psig	17 l/min @ 100 psig	(blank)
28" Hg Vac. to 50 psig	14 l/min @ 50 psig	-L
28" Hg Vac. to 25 psig	12.5 l/min @ 25 psig	-H

Example Part Numbers: ET-2M-12-V; CR-ET-2-12

¹Minimum order quantity required for EPDM or silicone seals

²Analytical series valves available in manifold mount only

³Not available for Oxygen Clean or Analytical series valves

⁴Available on EC (pin connector) models only

HIGH FLOW MOUSE VALVES

2-WAY N.C. HIGH FLOW VALVES, IN-LINE & MANIFOLD MOUNT

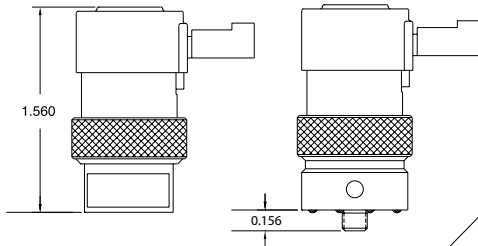

0 to 105 psig

0 to 50 psig

0 to 25 psig

12 VDC

24 VDC

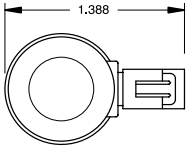
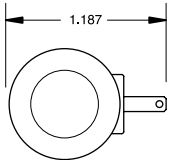
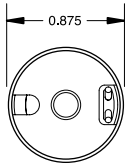
		Pressure Range			Voltage		In-Line Mount	Manifold Mount
 0.025" Pin Connector	•			•		ECR-2-12	ECR-2M-12	
	•			•	•	ECR-2-24	ECR-2M-24	
		•		•		ECR-2-12-L	ECR-2M-12-L	
		•		•	•	ECR-2-24-L	ECR-2M-24-L	
			•	•		ECR-2-12-H	ECR-2M-12-H	
			•	•	•	ECR-2-24-H	ECR-2M-24-H	
 Spade Terminals	•			•		ETR-2-12	ETR-2M-12	
	•			•	•	ETR-2-24	ETR-2M-24	
		•		•		ETR-2-12-L	ETR-2M-12-L	
		•		•	•	ETR-2-24-L	ETR-2M-24-L	
			•	•		ETR-2-12-H	ETR-2M-12-H	
			•	•	•	ETR-2-24-H	ETR-2M-24-H	
 Wire Leads Top (Axial)	•			•		EWR-2-12	EWR-2M-12	
	•			•	•	EWR-2-24	EWR-2M-24	
		•		•		EWR-2-12-L	EWR-2M-12-L	
		•		•	•	EWR-2-24-L	EWR-2M-24-L	
			•	•		EWR-2-12-H	EWR-2M-12-H	
			•	•	•	EWR-2-24-H	EWR-2M-24-H	

Medium	Clean, dry air (40 micron filter)
Power Consumption	1.2 watts
Temperature Range	32 to 150°F
Response Time	5 to 10 ms (nominal)
Operating Range	90 to 110% of rated voltage
Ports	#10-32
Seals	Nitrile standard; FKM, EPDM ¹ , and silicone ¹ available Analytical² : FKM standard; EPDM ¹ , silicone ¹ available
More Details	clippard.com/link/ev

Valve Series Prefix	Options Suffix
Analytical ²	A-
	Nitrile Seals ³
	FKM Seals
	EPDM Seals ¹
	Silicone Seals ¹
	Diode ⁴
	(blank)
	-V
	-E
	-S
	-D

Pressure Range	Air Flow	Options Suffix
0 to 100 psig	39.5 l/min @ 100 psig	(blank)
0 to 50 psig	31 l/min @ 50 psig	-L
0 to 25 psig	27 l/min @ 25 psig	-H

Example Part Numbers: ECR-2-12-V; A-EWR-2M-12

¹Minimum order quantity required for EPDM or silicone seals

²Analytical series valves available in manifold mount only

³Not available for Analytical series valves





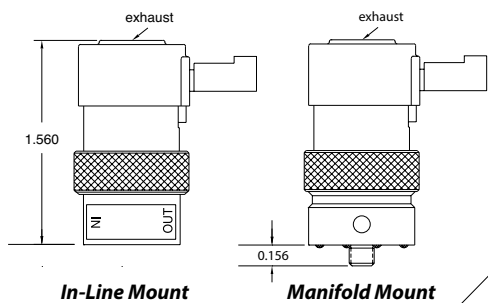

⁴Available on EC (pin connector) models only

See p. 10 for mounting option schematics

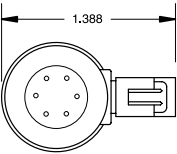
ORIGINAL EV SERIES MOUSE VALVES

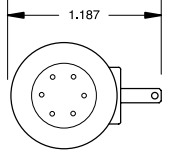
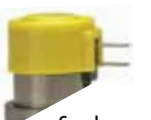
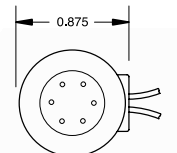
3-WAY N.C. VALVES, IN-LINE & MANIFOLD

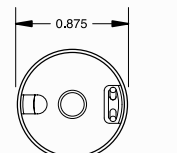

		Pressure Range			Voltage		In-Line Mount		Manifold Mount	
 0.025" Pin Connector		•	•	•	•	•	EC-3-12	EC-3M-12		
		•	•	•	•	•	EC-3-24	EC-3M-24		
		•	•	•	•	•	EC-3-12-L	EC-3M-12-L		
		•	•	•	•	•	EC-3-24-L	EC-3M-24-L		
		•	•	•	•	•	EC-3-12-H	EC-3M-12-H		
•	•	•	•	•	EC-3-24-H	EC-3M-24-H				
 Spade Terminals		•	•	•	•	•	ET-3-12	ET-3M-12		
		•	•	•	•	•	ET-3-24	ET-3M-24		
		•	•	•	•	•	ET-3-12-L	ET-3M-12-L		
		•	•	•	•	•	ET-3-24-L	ET-3M-24-L		
		•	•	•	•	•	ET-3-12-H	ET-3M-12-H		
•	•	•	•	•	ET-3-24-H	ET-3M-24-H				
 Wire Leads Side (Radial)		•	•	•	•	•	EV-3-12	EV-3M-12		
		•	•	•	•	•	EV-3-24	EV-3M-24		
		•	•	•	•	•	EV-3-12-L	EV-3M-12-L		
		•	•	•	•	•	EV-3-24-L	EV-3M-24-L		
		•	•	•	•	•	EV-3-12-H	EV-3M-12-H		
•	•	•	•	•	EV-3-24-H	EV-3M-24-H				
 Wire Leads Top (Axial)		•	•	•	•	•	EW-3-12	EW-3M-12		
		•	•	•	•	•	EW-3-24	EW-3M-24		
		•	•	•	•	•	EW-3-12-L	EW-3M-12-L		
		•	•	•	•	•	EW-3-24-L	EW-3M-24-L		
		•	•	•	•	•	EW-3-12-H	EW-3M-12-H		
•	•	•	•	•	EW-3-24-H	EW-3M-24-H				

Medium	Clean, dry air (40 micron filter)
Power Consumption	0.67 watts; Corrosion-Resistant: 1.2 watts
Temperature Range	32 to 180°F; Corrosion-Resistant: 32 to 150°F
Response Time	5 to 10 ms (nominal)
Operating Range	Standard: 90 to 150% of rated voltage Corrosion-Resistant: 90 to 110%
Ports	#10-32
Seals	Nitrile standard; FKM, EPDM ¹ , and silicone ¹ available Oxygen Clean: FKM only Analytical²: FKM standard; EPDM ¹ , silicone ¹ available
More Details	clippard.com/link/ev

See p. 10 for mounting option schematics

Valve Series Prefix		Options Suffix	
Oxygen Clean	0-	Nitrile Seals ³	(blank)
Analytical ²	A-	FKM Seals	-V
Corrosion-Resistant	CR-	EPDM Seals ^{1,3}	-E
		Silicone Seals ^{1,3}	-S
		Diode ⁴	-D

Pressure Range	Air Flow	Options Suffix
28" Hg Vac. to 105 psig	17 l/min @ 100 psig	(blank)
28" Hg Vac. to 50 psig	14 l/min @ 50 psig	-L
28" Hg Vac. to 25 psig	12.5 l/min @ 25 psig	-H

Example Part Numbers: ET-3-12-S; 0-EW-3-24

¹Minimum order quantity required for EPDM or silicone seals

²Analytical series valves available in manifold mount only

³Not available for Oxygen Clean or Analytical series valves





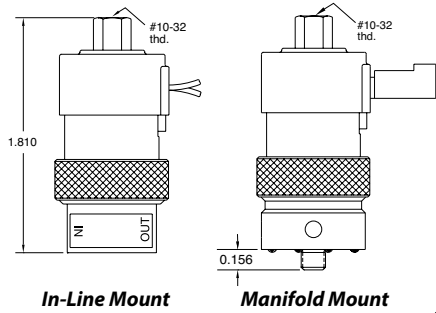

⁴Available on EC (pin connector) models only

ORIGINAL EV SERIES MOUSE VALVES

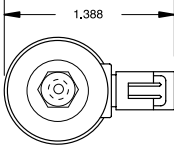
3-WAY FULLY-PORTED VALVES, IN-LINE & MANIFOLD

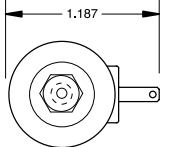
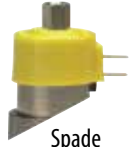
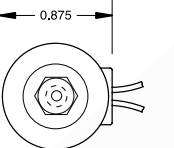

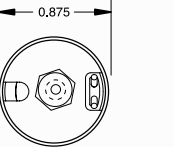
Vac. to 105 psig
 Vac. to 50 psig
 Vac. to 25 psig
 12 VDC
 24 VDC

		Pressure Range			Voltage		In-Line Mount	Manifold Mount
 0.025" Pin Connector		•			•		ECO-3-12	ECO-3M-12
		•			•	•	ECO-3-24	ECO-3M-24
			•		•	•	ECO-3-12-L	ECO-3M-12-L
			•		•	•	ECO-3-24-L	ECO-3M-24-L
			•		•	•	ECO-3-12-H	ECO-3M-12-H
	•		•	•	ECO-3-24-H	ECO-3M-24-H		
 Spade Terminals		•			•		ETO-3-12	ETO-3M-12
		•			•	•	ETO-3-24	ETO-3M-24
			•		•	•	ETO-3-12-L	ETO-3M-12-L
			•		•	•	ETO-3-24-L	ETO-3M-24-L
			•		•	•	ETO-3-12-H	ETO-3M-12-H
	•		•	•	ETO-3-24-H	ETO-3M-24-H		
 Wire Leads Side (Radial)		•			•		EVO-3-12	EVO-3M-12
		•			•	•	EVO-3-24	EVO-3M-24
			•		•	•	EVO-3-12-L	EVO-3M-12-L
			•		•	•	EVO-3-24-L	EVO-3M-24-L
			•		•	•	EVO-3-12-H	EVO-3M-12-H
	•		•	•	EVO-3-24-H	EVO-3M-24-H		
 Wire Leads Top (Axial)		•			•		EWO-3-12	EWO-3M-12
		•			•	•	EWO-3-24	EWO-3M-24
			•		•	•	EWO-3-12-L	EWO-3M-12-L
			•		•	•	EWO-3-24-L	EWO-3M-24-L
			•		•	•	EWO-3-12-H	EWO-3M-12-H
	•		•	•	EWO-3-24-H	EWO-3M-24-H		

Medium	Clean, dry air (40 micron filter)
Power Consumption	0.67 watts; Corrosion-Resistant: 1.2 watts
Temperature Range	32 to 180°F; Corrosion-Resistant: 32 to 150°F
Response Time	5 to 10 ms (nominal)
Operating Range	90 to 150% of rated voltage Corrosion-Resistant: ±10%
Ports	#10-32
Seals	Nitrile standard; FKM, EPDM ¹ , and silicone ¹ available Oxygen Clean: FKM only Analytical²: FKM standard; EPDM ¹ , silicone ¹ available
More Details	clippard.com/link/ev

See p. 10 for mounting option schematics

Valve Series Prefix		Options Suffix	
Oxygen Clean	O-	Nitrile Seals ³	(blank)
Analytical ²	A-	FKM Seals	-V
Corrosion-Resistant	CR-	EPDM Seals ¹	-E
		Silicone Seals ¹	-S
		Diode ⁴	-D

Pressure Range	Air Flow	Options Suffix
28" Hg Vac. to 105 psig	17 l/min @ 100 psig	(blank)
28" Hg Vac. to 50 psig	14 l/min @ 50 psig	-L
28" Hg Vac. to 25 psig	12.5 l/min @ 25 psig	-H

Example Part Numbers: ETO-3M-24-D; CR-EVO-3-12

¹Minimum order quantity required for EPDM or silicone seals

²Analytical series valves available in manifold mount only

³Not available for Oxygen Clean or Analytical series valves

⁴Available on EC (pin connector) models only

ECN, ETN, EVN SERIES MOUSE VALVES

2-WAY & 3-WAY N.O. VALVES, MANIFOLD

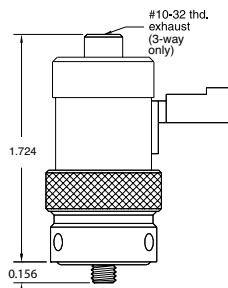

12 VDC 24 VDC

		Voltage	2-Way	3-Way
 0.025" Pin Connector		•	ECN-2M-12	ECN-3M-12
		•	ECN-2M-24	ECN-3M-24
 Spade Terminals		•	ETN-2M-12	ETN-3M-12
		•	ETN-2M-24	ETN-3M-24
 Wire Leads Side (Radial)		•	EVN-2M-12	EVN-3M-12
		•	EVN-2M-24	EVN-3M-24

Medium	Clean, dry air (40 micron filter)
Power Consumption	0.67 watts
Temperature Range	32 to 180°F
Response Time	5 to 10 ms (nominal)
Operating Range	90 to 150% of rated voltage
Voltage	12 VDC or 24 VDC; other voltages available
Ports	#10-32
Seals	Nitrile standard; FKM, EPDM ¹ , and silicone ¹ available
More Details	clippard.com/link/ecn

See p. 10 for mounting option schematics

Pressure Range Air Flow

28" Hg Vac. to 105 psig 25 l/min @ 100 psig

Options Suffix

Nitrile Seals	(blank)
FKM Seals	-V
EPDM Seals ¹	-E
Silicone Seals ¹	-S
Diode ²	-D

Example Part Numbers: EVN-2M-12-V; ETN-3M-24

¹Minimum order quantity required for EPDM or silicone seals

²Diode available on ECN (pin connector) models only

INTRINSICALLY SAFE MOUSE VALVES

2-WAY & 3-WAY N.C. VALVES, IN-LINE & MANIFOLD

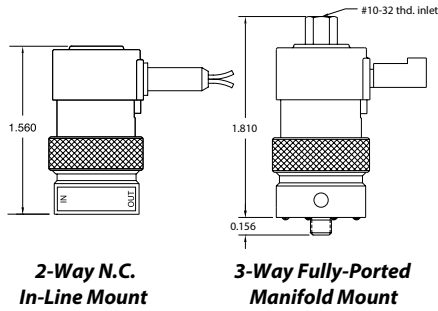

Vac. to 105 psig
 Vac. to 50 psig
 Vac. to 25 psig

		Pressure Range		In-Line Mount	Manifold Mount
2-Way Normally-Closed	 0.025" Pin Connector	•		EI-2-15.5	EI-2M-15.5
			•	EI-2-15.5-L	EI-2M-15.5-L
	 18 Gauge Leads			EI-2-15.5-H	EI-2M-15.5-H
		•		EI-2-15.5-C	EI-2M-15.5-C
			•	EI-2-15.5-LC	EI-2M-15.5-LC
			•	EI-2-15.5-HC	EI-2M-15.5-HC
3-Way Normally-Closed	 0.025" Pin Connector	•		EI-3-15.5	EI-3M-15.5
			•	EI-3-15.5-L	EI-3M-15.5-L
	 18 Gauge Leads			EI-3-15.5-H	EI-3M-15.5-H
		•		EI-3-15.5-C	EI-3M-15.5-C
			•	EI-3-15.5-LC	EI-3M-15.5-LC
			•	EI-3-15.5-HC	EI-3M-15.5-HC
3-Way Fully-Ported	 0.025" Pin Connector	•		EIO-3-15.5	EIO-3M-15.5
			•	EIO-3-15.5-L	EIO-3M-15.5-L
	 18 Gauge Leads			EIO-3-15.5-H	EIO-3M-15.5-H
		•		EIO-3-15.5-C	EIO-3M-15.5-C
			•	EIO-3-15.5-LC	EIO-3M-15.5-LC
			•	EIO-3-15.5-HC	EIO-3M-15.5-HC

Medium	Clean, dry air (40 micron filter)
Power Consumption	0.67 watts
Temperature Range	32 to 104°F
Response Time	5 to 10 ms (nominal)
Operating Range	90 to 150% of rated voltage
Voltage	15.5 VDC
Ports	#10-32 and manifold mount
Seals	Nitrile standard; FKM and EPDM ¹ available
More Details	clippard.com/link/analytical

Pressure Range	Air Flow	Options Suffix
28" Hg Vac. to 105 psig	17 l/min @ 100 psig	(blank)
28" Hg Vac. to 50 psig	14 l/min @ 50 psig	-L
28" Hg Vac. to 25 psig	12.5 l/min @ 25 psig	-H

Options Suffix	
Nitrile Seals	(blank)
FKM Seals	-V
EPDM Seals ¹	-E

Example Part Numbers: EIO-3-15.5-LC; EI-2-15.5

¹Minimum order quantity required for EPDM seals

See p. 10 for mounting option schematics

MOUSE VALVE MANIFOLDS

OXYGEN CLEAN

Oxygen series products are specially manufactured and assembled for applications in oxygen-enriched environments. Each manifold is cleaned according to Clippard Specification #ES-3.41 and double bagged in heat sealed polyethylene bags.

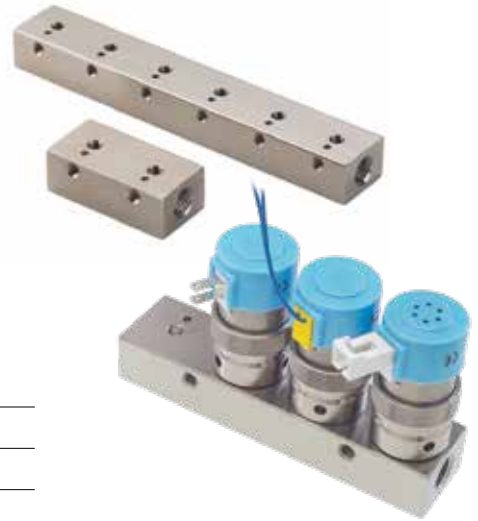

Part No.	Description
O-15581-2	Single-Sided, 2-Station
O-15581-4	Single-Sided, 4-Station
O-15581-6	Single-Sided, 6-Station
O-15582-8	Double-Sided, 8-Station
O-15582-12	Double-Sided, 12-Station

Input Ports	In-line 1/8" NPT
Outlet Ports	#10-32
Mounting	#10-32 tapped holes
Materials	ENP Brass

MULTI-VALVE MANIFOLDS



Black anodized aluminum

Part No.	Description
15481-2	Single-Sided, 2-Station
15481-4	Single-Sided, 4-Station
15481-6	Single-Sided, 6-Station
15482-8	Double-Sided, 8-Station
15482-12	Double-Sided, 12-Station

ET VALVE CONNECTORS



Black molded lug connectors are available for easy push-on connection

Part No.	Description
ET-C48	48° Connector
ET-C120	120° Connector

EC & EI CONNECTORS



TE Connectivity #5-103956-1 for EC/ECO and EI/EIO valves

Part No.	Description
C2-RB18	18° Connector
C2-RB120	120° Connector

SPECIALIZED MANIFOLDS *ENP brass and oxygen clean also available*



15490-2 shown

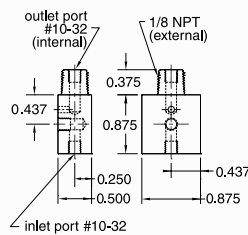

Part No. 15490-1
Description #10-32 Inlet, 1/8" NPT Outlet

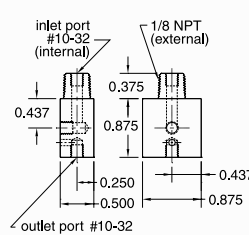

Part No. 15490-2
Description 1/8" NPT Inlet, #10-32 Outlet

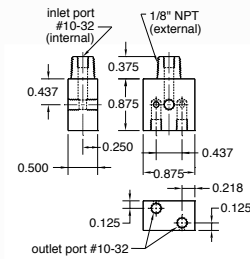

Part No. 15490-3
Description 1/8" NPT Inlet, #10-32 Outlet



15491-1 shown

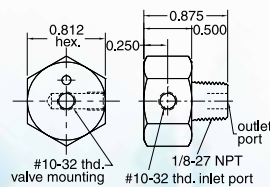

Part No. 15491-1
Description #10-32 Inlet, 1/8" NPT Outlet

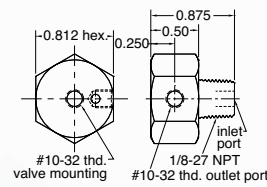

Part No. 15491-2
Description 1/8" NPT Inlet, #10-32 Outlet

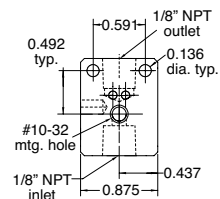

Part No. 15490-5
Description 1/8" NPT Inlet, 1/8" NPT Outlet

Clippard Electronic Manifold Cards

Auxiliary Power Input

Power to operate the valves may be provided through two sources: ONE, through the 25-pin connector if your signal source also has sufficient power to operate the bank of valves, or TWO, through a separate auxiliary power input connection built into the board. To isolate power use the power source selector switch.

Reverse Polarity Protection

Circuit using diodes and capacitor provides input voltage protection against reverse polarity.

Note: In applying power on a temporary basis, use care to observe proper circuit polarity.

Power Selector Switch

Enables choice of power input source (25-pin connector or auxiliary).

Printed Circuit Board

Durable laminated fiberglass

Resistor-Diode-LED Circuit

Individual circuit to each valve provides protection against shut-off spikes. LED is illuminated when valve is actuated.

3-Position Detented Switches

Provides for ON power, valve is activated; OFF power, valve is not connected; CONN valve is connected to 25-pin connector and will be controlled through it.



To configure manifold cards, visit clippard.com/link/mc

25-Pin Connector

Clippard Valve Manifold

Compact, efficient mounting of the valves is achieved with Clippard multi-valve manifolds.

Clippard Electronic Valves

LED Bank

Illuminated LED signals that the valve is actuated.

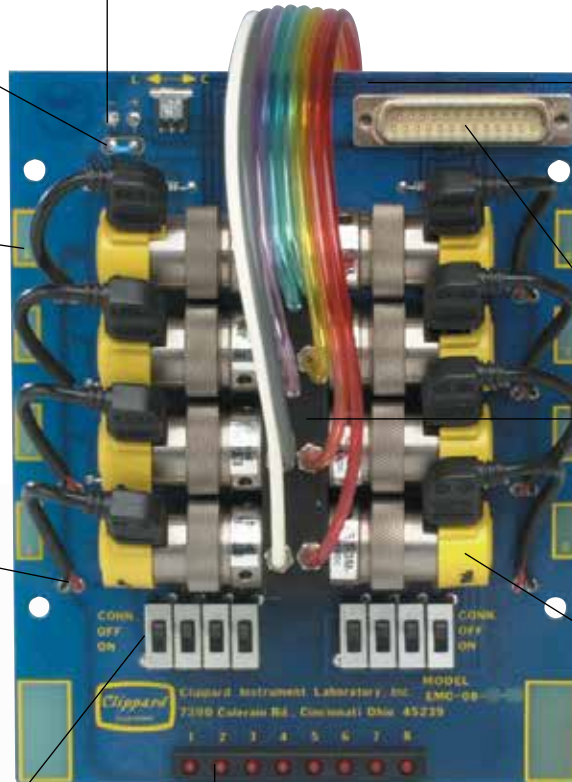

Now you can direct low-voltage DC signals from controllers, systems, computers, or other sources to operate powerful pneumatic valves with a minimum of piping and hook-up.

Self-contained card includes:

- 8 or 12 Clippard ET interface valves
- Manifold mount for single air supply
- Circuit board fully wired
- Instant plug-in with 25-pin connector
- Resistor, diode, LED and switch for each valve
- Auxiliary power supply connection

- Fast, easy to mount
- Pre-assembled; all valves mounted
- Low power requirements (0.67 watt per valve)
- Choice of valve types
- Each valve switchable
- Shut-off spike protection
- No expensive card rack required

EM SERIES MOUSE VALVES

2-WAY & 3-WAY N.O. & N.C. VALVES, MANIFOLD MOUNT

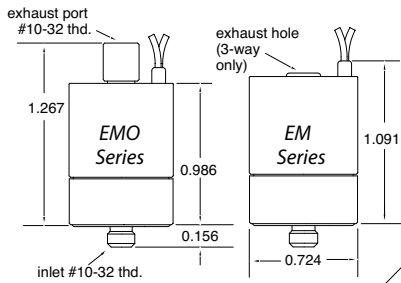

Vac. to 105 psig
 Vac. to 50 psig
 Vac. to 25 psig
 12 VDC
 24 VDC

	Pressure Range	Voltage	2-Way N.C.	3-Way N.C.	3-Way N.O./N.C.
	•	•	EM-2-12 EM-2-24		
	•	•	EM-2-12-L EM-2-24-L		
	•	•	EM-2-12-H EM-2-24-H		
	•	•		EM-3-12 EM-3-24	
	•	•		EM-3-12-L EM-3-24-L	
	•	•		EM-3-12-H EM-3-24-H	
	•	•			EMO-3-12 EMO-3-24
	•	•			EMO-3-12-L EMO-3-24-L
	•	•			EMO-3-12-H EMO-3-24-H

At just over 1" tall and less than 3/4" in diameter, the EM series is an ideal choice when space is critical. This reliable, proven design is housed in a miniature body with wire leads out the top to allow body rotation for close-center mounting. High flow combined with fast shifting speed, extremely high cycle life, and design flexibility make this valve a small wonder for demanding applications.

Medium	Clean, dry air (40 micron filter)
Power Consumption	1 watt
Temperature Range	32 to 150°F
Response Time	10 ms nominal; 15 ms N.O.
Operating Range	90 to 120% of rated voltage
Voltage	12 VDC or 24 VDC; other voltages available
Ports	#10-32 exhaust (EMO)
Seals	Nitrile standard; FKM, EPDM ¹ , and silicone ¹ available
More Details	clippard.com/link/em

¹Minimum order quantity required for EPDM or silicone seals

Pressure Range	Air Flow	Options Suffix
28" Hg Vac. to 105 psig	17 l/min @ 100 psig	(blank)
28" Hg Vac. to 50 psig	14 l/min @ 50 psig	-L
28" Hg Vac. to 25 psig	12.5 l/min @ 25 psig	-H

Options Suffix	
Nitrile Seals	(blank)
FKM Seals	-V
EPDM Seals ¹	-E
Silicone Seals ¹	-S

MANIFOLDS

Black anodized aluminum



Description	Part No.
Single-Sided, 2-Station	15681-2
Single-Sided, 4-Station	15681-4
Single-Sided, 6-Station	15681-6
Single-Sided, 8-Station	15681-8
Double-Sided, 8-Station	15482-8
Double-Sided, 12-Station	15482-12
Double-Sided, 16-Station	15482-16

ES & ESO Series Mouse Valves

Valves are small in size with a variety of coil voltages and flow options. Mounting is as close as 7/8" on center.

ESO and similar styles have top hose barb or #10-32 threaded fitting for N.C. exhaust or N.O. inlet.

Housing is molded Zytel® ST 801 for toughness and rigidity

Valves feature low power, cool running, quiet operation and fast response time. They convert low voltage, low current signals into high pressure pneumatic outputs.

For more details, visit clippard.com/link/es

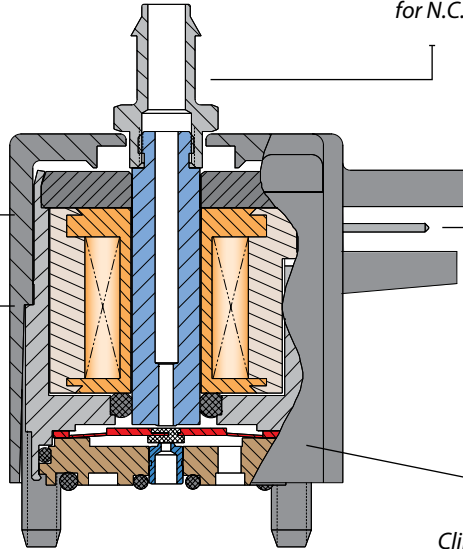

Coils are available to mate with TE Connectivity #5-103956-2 connector or with 18" wire leads which utilize #26 wire.

Clippard ES valves are unique, with only one internal moving part that travels a mere 0.007".



- Close mounting—7/8" on center and overall height less than 1"
- Easy to mount on manifold with two #4-40 screws
- Geometric design
- Polymer housing—Zytel ST 801® super tough
- TE connectivity-style pin connection or 18" wire leads
- Flow up to 17 l/min

Zytel ST 801® Super Tough and Zytel® are registered trademarks of DuPont™

Voltage*	Nominal Current	Resistance	Power	Working Range
12 VDC	0.083 amps	144 ohms	1.0 watt	90 to 120% of rated voltage (cont. duty)
24 VDC	0.042 amps	576 ohms	1.0 watt	

*Other voltages available—call 877-245-6247

The ES valve, like Clippard EV and ET valves, converts low voltage, low current signals into high pressure (0 to 105 psig) pneumatic outputs utilizing a unique, patented valving principle.



Since there are no sliding parts, and complete poppet travel is only 0.007", low power consumption and exceptionally long life are assured with this design.

No flow is required for cooling because the compact ES is both quiet and exceptionally cool in operation.

The compact nature of design makes this valve well suited to a wide range of applications in biomedical, environmental test equipment, textile machines, packaging machinery, computerized industrial automation, and portable systems.

ES SERIES MOUSE VALVES

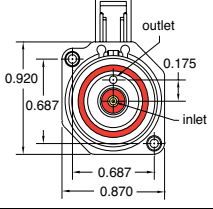
2-WAY & 3-WAY N.C. VALVES

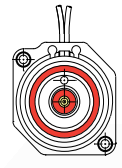
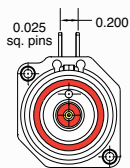
		Pressure Range			Voltage		2-Way	3-Way
		Vac. to 105 psig	Vac. to 50 psig	Vac. to 25 psig	12 VDC	24 VDC		
 <p>Side Pin Connector</p>	•				•		ES-2S-12	ES-3S-12
	•				•		ES-2S-24	ES-3S-24
		•			•		ES-2S-12-L	ES-3S-12-L
		•			•		ES-2S-24-L	ES-3S-24-L
			•		•		ES-2S-12-H	ES-3S-12-H
			•		•		ES-2S-24-H	ES-3S-24-H
 <p>Top Pin Connector</p>	•				•		ES-2T-12	ES-3T-12
	•				•		ES-2T-24	ET-3T-24
		•			•		ES-2T-12-L	ES-3T-12-L
		•			•		ES-2T-24-L	ES-3T-24-L
			•		•		ES-2T-12-H	ES-3T-12-H
			•		•		ES-2T-24-H	ES-3T-24-H
 <p>Wire Leads Side (Radial)</p>	•				•		ES-2W-12	ES-3W-12
	•				•		ES-2W-24	ES-3W-24
		•			•		ES-2W-12-L	ES-3W-12-L
		•			•		ES-2W-24-L	ES-3W-24-L
			•		•		ES-2W-12-H	ES-3W-12-H
			•		•		ES-2W-24-H	ES-3W-24-H
 <p>Board Mount</p>	•				•		ES-2B-12	ES-3B-12
	•				•		ES-2B-24	ES-3B-24
		•			•		ES-2B-12-L	ES-3B-12-L
		•			•		ES-2B-24-L	ES-3B-24-L
			•		•		ES-2B-12-H	ES-3B-12-H
			•		•		ES-2B-24-H	ES-3B-24-H

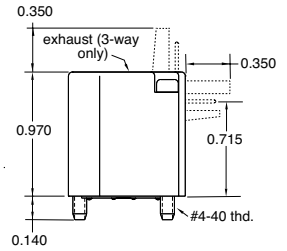

Medium	Clean, dry air (40 micron filter)
Power Consumption	1 watt at rated voltage
Temperature Range	32 to 150°F
Response Time	5 to 10 ms (nominal)
Operating Range	90 to 120% of rated voltage
Voltage	12 VDC or 24 VDC
Ports	Inlet and outlet through manifold 3-Way: Exhaust through top of valve
Seals	Nitrile standard; FKM, EPDM ¹ , and silicone ¹ available
More Details	clippard.com/link/es

See p. 13 for flow charts

¹Minimum order quantity required for EPDM or silicone seals

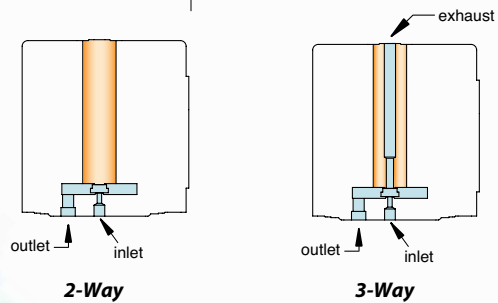

Pressure Range	Air Flow	Options Suffix
28" Hg Vac. to 105 psig	17 l/min @ 100 psig	(blank)
28" Hg Vac. to 50 psig	14 l/min @ 50 psig	-L
28" Hg Vac. to 25 psig	12.5 l/min @ 25 psig	-H

Options Suffix	
Nitrile Seals	(blank)
FKM Seals	-V
EPDM Seals ¹	-E
Silicone Seals ¹	-S

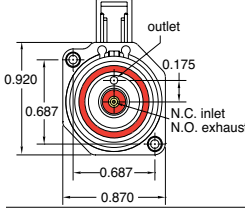

ESO SERIES MOUSE VALVES

3-WAY FULLY-PORTED VALVES

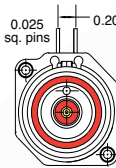
		Vac. to 105 psig	Vac. to 50 psig	Vac. to 25 psig	12 VDC	24 VDC	Part No.
 <p>Side Pin Connector</p>	•				•		ESO-3S-12
	•				•		ESO-3S-24
		•				•	ESO-3S-12-L
		•				•	ESO-3S-24-L
 <p>Top Pin Connector</p>	•				•		ESO-3T-12
	•				•		ETO-3T-24
		•				•	ESO-3T-12-L
		•				•	ESO-3T-24-L
 <p>Wire Leads Side (Radial)</p>	•				•		ESO-3W-12
	•				•		ESO-3W-24
		•				•	ESO-3W-12-L
		•				•	ESO-3W-24-L
 <p>Board Mount</p>	•				•		ESO-3B-12
	•				•		ESO-3B-24
		•				•	ESO-3B-12-L
		•				•	ESO-3B-24-L
					•		ESO-3B-12-H
					•		ESO-3B-24-H

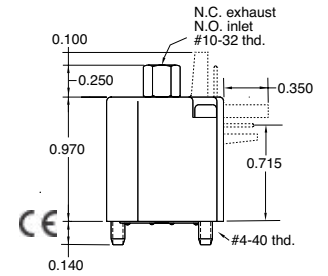

Top Port Options (below)

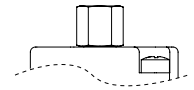

#10-32 (standard)

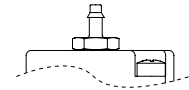

1/16" I.D. Hose Barb (option "-1")

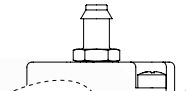

1/8" I.D. Hose Barb (option "-2")

Medium	Clean, dry air (40 micron filter)
Power Consumption	1 watt at rated voltage
Temperature Range	32 to 150°F
Response Time	5 to 10 ms (nominal)
Operating Range	90 to 120% of rated voltage
Voltage	12 VDC or 24 VDC
Normally-Closed Ports	Inlet and outlet through manifold, exhaust through top of valve (#10-32)
Normally-Open Ports	Exhaust and outlet through manifold, inlet through top of valve (#10-32)
Seals	Nitrile standard; FKM, EPDM ¹ , and silicone ¹ available
More Details	clippard.com/link/es

See p. 13 for flow charts • For cable & connectors, see p. 20

¹Minimum order quantity required for EPDM or silicone seals

Pressure Range	Air Flow	Options Suffix
28" Hg Vac. to 105 psig	17 l/min @ 100 psig	(blank)
28" Hg Vac. to 50 psig	14 l/min @ 50 psig	-L
28" Hg Vac. to 25 psig	12.5 l/min @ 25 psig	-H

Options Suffix	
Nitrile Seals	(blank)
FKM Seals	-V
EPDM Seals ¹	-E
Silicone Seals ¹	-S
1/16" I.D. Hose Barb	-1
1/8" I.D. Hose Barb	-2

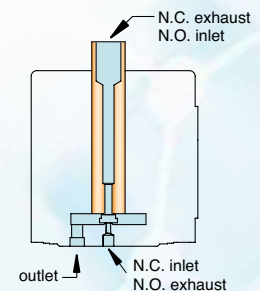

ES & ESO SERIES MOUSE VALVE MANIFOLDS

SINGLE- & MULTI-STATION MANIFOLDS



REAR MOUNT MANIFOLD



DUAL MOUNT MANIFOLD



Part No.	Description
26090-1	Single-Station, Side Port
26090-2	Single-Station, Bottom Port
26090-3	Double-Station

Part No.	Description
26083-4	4-Station Single-Sided
26083-6	6-Station Single-Sided
26083-8	8-Station Single-Sided
26084-8	8-Station Double-Sided
26084-12	12-Station Double-Sided
26084-16	16-Station Double-Sided

Part No.	Description
26081-4	4-Station Single-Sided
26081-6	6-Station Single-Sided
26081-8	8-Station Single-Sided
26082-12	12-Station Double-Sided
26082-16	16-Station Double-Sided

ACCESSORIES

Cover for an individual, unused manifold station.

Part No. ESM-CP



TE Connectivity #5-103956-2 with 18" Wire Leads.
#26 Gauge. Part No. C3-RXB18

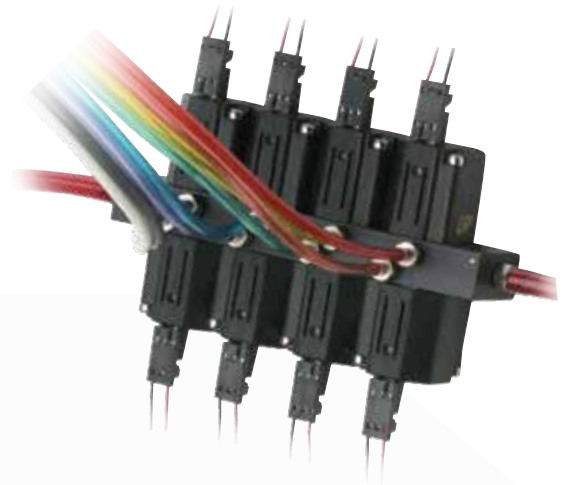

For all the latest product news and updates, visit us online at **clippard.com**

Product Specifications • 2D & 3D Files • Online Ordering



SOLENOID VALVE **OVERVOLTAGE**

Every solenoid valve has a nominal actuation voltage, which is usually based on common power supply voltages such as 12 VDC, 24 VDC, 110 VAC, or 220 VAC. The nominal voltage is typically printed somewhere on the valve body or coil and is the voltage required to actuate (shift) the valve.

Applying less than the nominal voltage will result in undervoltage and may result in a slower “on” response time or the valve not actuating at all. Applying more than the nominal voltage will result in overvoltage, which can result in a faster “on” response time of a valve. However, extreme overvoltage could permanently damage the coil.

NOMINAL VS. RATED VOLTAGE

Most solenoid valves also have a rated voltage range, such as +/- 10% of the nominal voltage. For example, a 12 VDC +/- 10% rated voltage would allow between 10.8 VDC and 13.2 VDC to be applied to a solenoid and still achieve normal operation for the valve.

BENEFITS & DRAWBACKS

Users will sometimes intentionally overvoltage solenoid valves while remaining within the rated voltage range in order to get a faster “on” response time. While this will not damage the solenoid, it is important to understand the benefits and drawbacks when doing this.

Benefits:

- “On” response time will decrease as voltage is increased

Drawbacks:

- “Off” response time will increase as voltage is increased
- Power required will increase as voltage is increased
- Due to increased power usage, heat generation will also increase

CLIPPARD VALVES & OVERVOLTAGE

Many of Clippard’s valves actually allow a significant overvoltage. Our EV series valves, for instance, are rated for 90-150% of the nominal voltage, as are our 2013 series valves. Our DV series valves are rated for 95-125% of the nominal voltage and our NIV isolation valves are rated for 100-120% of the nominal voltage. This allows customers to get faster “on” response times if their application requires it.

Questions? Call **877-245-6247** or contact your local Clippard distributor.



EV / ET Coil Rated Voltage Ranges



Solenoid	Working Range
0.8VDC	0.7 - 1.2VDC
1.4VDC	1.3 - 2.1VDC
3VDC	2.7 - 4.5VDC
5VDC	4.5 - 7.5VDC
5.7VDC	5.1 - 8.5VDC
6VDC	5.4 - 9.0VDC
9VDC	8.1 - 14.0VDC
12VDC	10.8 - 18.0VDC
15.5VDC	14.0 - 23.0VDC
18VDC	16.0 - 27.0VDC
24VDC	21.5 - 36.0VDC

2013 Coil Rated Voltage Ranges



Solenoid	Working Range
6VDC	5.4 - 9.0VDC
12VDC	10.8 - 18.0VDC
24VDC	21.5 - 36.0VDC

DV Coil Rated Voltage Ranges



Solenoid	Working Range
12VDC	10.8 - 15.0VDC
24VDC	21.6 - 30.0VDC

LEAK DETECTION

Understandably, manufacturers of leak decay testing equipment have especially high standards for the valves they use. In order for their testing equipment to function, it must hold a pressure or vacuum over a period of time, which is not possible if the valve leakage exceeds a certain amount. However, low leak valves are critical in other situations as well—such as for performing chemical analysis, controlling a flammable gas, or achieving a particular level of vacuum. When your application is very sensitive to leaks, how does Clippard ensure that your valve meets your requirements?



Leaks in a valve are characterized by a leak rate, which is often given as a volumetric flow rate at a standard temperature and pressure (e.g. standard cubic centimeters per minute; sccm). The standard conditions take away any ambiguity about how much gas (in terms of mass) is leaking out. In many cases, but not all, the standard pressure is 1 atm and the standard temperature is 20° C. Since even units that have the “standard” word in them do not necessarily reference the same standard, other units have the standard pressure built right into them, such as atm-cc/s and Pa-m³/s. According to the NIST website, any volumetric flow rate that includes “atm” also assumes that the standard temperature is 0°C.

There are many ways that valves can be checked for leaks. Clippard uses two of the most popular ways: pressure decay testing and helium leak detection.

PRESSURE DECAY TESTING

Pressure decay methods are an easy choice for many applications. Though decay testers can be quite sophisticated, they are fairly simple in theory. The integrity of the seals of a valve can be measured by how well the valve holds pressure in an otherwise closed volume. The tester pressurizes the volume with a gas, closes the volume, allows the pressure to stabilize, and then measures the volume pressure. After a specified amount of time it reads the pressure again. The amount of the pressure drop between the first reading and the second reading is an indication in the size of the leak in the VUT.

Pressure decay testing can very effectively determine whether a valve is bubble tight, but its sensitivity is limited. Increasing its sensitivity requires very long test times, and a pressure decay test does not by itself give customers a good indication of the actual leak rate of the valve. The relationship between leak rate and pressure decay depends on the size of the volume under test and the length of time between the two pressure readings. To overcome these limitations, Clippard utilizes helium leak detection.

HELIUM LEAK DETECTION

A helium leak detector uses a mass spectrometer that is calibrated to detect helium ions in a very deep vacuum. The valve-under-test is connected by fixturing to the test port of the detector, and the detector is then pumped down to the test vacuum level. Once the proper test vacuum has been achieved, the tester is zeroed to get rid of background helium levels. Then helium is sprayed around the VUT. If there is a detectable leak, the mass spectrometer quickly starts to see an increase of helium. The number of helium ions counted by the mass spec is expressed as a leak rate of the VUT.

For more information about Clippard's leak testing capabilities, call **877-245-6247** or contact your local Clippard distributor.

7 MM VALVES

2-WAY & 3-WAY SUBMINIATURE VALVES



Valve Type	2-Way and 3-Way Normally-Closed
Medium	Air, water, gas, or compatible fluids
Nominal Power	0.5 to 1.2 watts
Response Time	<5 ms*
Temperature Range	32 to 122°F
Electrical Connection	3" Wire Leads
Voltage	12 VDC or 24 VDC
Mounting	Cartridge
Wetted Materials	Stainless Steel
Seal Material	FKM standard, EPDM available
More Details	clippard.com/link/sv

*Customizable to the specifications of the application. Call 877-245-6247.

Type	Pressure	Orifice	Part No.	Voltage
2-Way	0 to 145 psig	0.012"	SV-2C-12-3-V	12 VDC
			SV-2C-24-3-V	24 VDC
	0 to 45 psig	0.039"	SV-2C-12-10-V	12 VDC
			SV-2C-24-10-V	24 VDC
3-Way	0 to 144 psig	0.012"	SV-3C-12-3-V	12 VDC
			SV-3C-24-3-V	24 VDC
	0 to 22 psig	0.039"	SV-3C-12-10-V	12 VDC
			SV-3C-24-10-V	24 VDC



SINGLE-STATION MANIFOLD

Black anodized aluminum.
Other materials available.

Part No.	Description
SVM-01	Single-Station Manifold, #10-32
M-SVM-01	Single-Station Manifold, M5
SVM-MC	Mounting Clip & Screw Only

These direct actuating valves offer an extremely fast response time for accurate dosing of minute volumes with the same long life you expect from the original Clippard EV line of electronic valves, in a 7 mm cartridge package. Due to very low moving weights, they are extremely quiet and emit very low vibration. Subminiature size and low energy consumption make them ideal for transportable and mobile systems, among others.

Standard products offered will fit the needs of most applications, however this series can be fully customized according to the user's unique requirements.

- 1,000,000,000+ cycle life
- Extremely minimal dead volume
- Low vibration and noise
- 100% tested

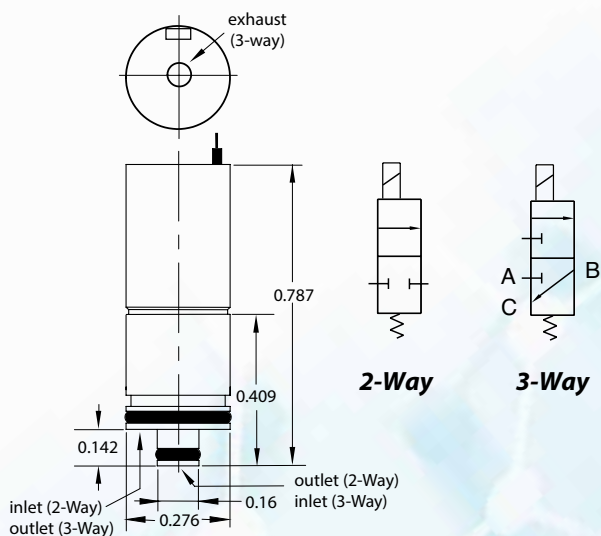
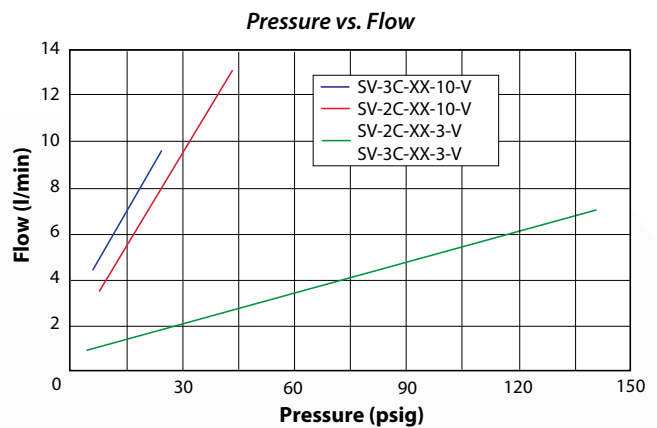

8 MM VALVES

3-WAY SUBMINIATURE VALVES



- 1,000,000,000+ cycle life
- Extremely small dead volume
- Low vibration and noise
- Exceptional repeatability and reliability
- Compact and ideal for sub-assemblies
- 100% tested

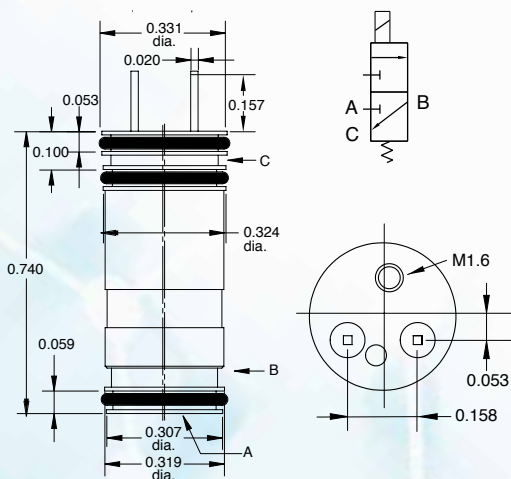
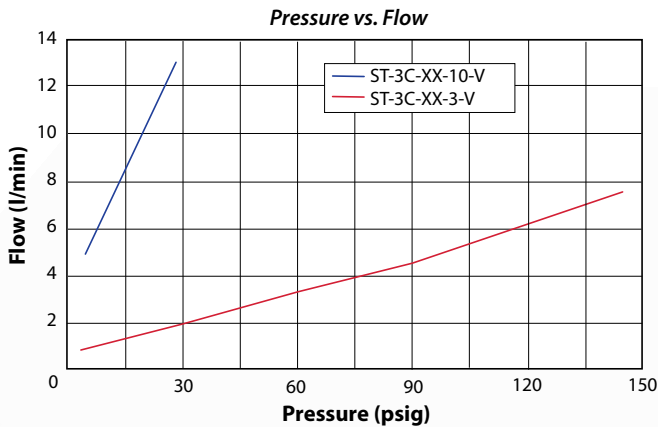

These direct actuating valves offer an extremely fast response time for accurate dosing of minute volumes with the same long life you expect from the original Clippard EV line of electronic valves, in a 8 mm cartridge package. Due to very low moving weights, they are extremely quiet and emit very little vibration. Subminiature size and low energy consumption make them ideal for many medical and diagnostic applications.

Standard products offered will fit the needs of most applications, however this series can be fully customized according to the user's unique requirements. Consult Clippard with your specific application.

Valve Type	3-Way, Normally-Closed
Medium	Air, water, gas, or compatible fluids
Nominal Power	0.55 watts*
Response Time	<5 ms*
Temperature Range	32 to 122°F
Electrical Connection	Terminal pins
Voltage	12 VDC or 24 VDC*
Mounting	Cartridge
Wetted Materials	Stainless steel
Seal Material	FKM standard; EPDM available
More Details	clippard.com/link/st

*Customizable to the specifications of the application. Call 877-245-6247.

Part No.	Pressure	Orifice	Voltage
ST-3C-12-3-V	0 to 145 psig	0.012"	12 VDC
ST-3C-24-3-V			24 VDC
ST-3C-12-10-V	0 to 29 psig	0.039"	12 VDC
ST-3C-24-10-V			24 VDC

SINGLE-STATION MANIFOLD

Part No.	Description
STM-01	Single-Station Manifold, #10-32
M-STM-01	Single-Station Manifold, M5

Black anodized aluminum manifold comes with mounting screw. Other materials available.



PROBLEM

Highly specialized equipment often presents very specific design challenges. This can be especially true in laboratory or analytical environments where the optimization of new equipment requires special components that are able to meet unique demands such as specific pressure, flow, and heat requirements. This OEM's system was leaking, but the fix would not be simple. Their application included a long list of critical specifications. On top of needing to maintain an existing footprint, the system also needed to minimize internal volume, could not generate much heat, and had to control a precise flow at a very specific pressure.

SOLUTION

While the requirements may seem daunting, this is just the type of problem that Clippard excels at solving. Our subminiature 8 mm valves provide precise, accurate flow control and generate very little heat—they were perfectly suited for this application. The OEM's existing system was leaking, so Clippard closely examined factors which could be contributing to this. Replacing the valves was a step forward, but Clippard also found that the gaskets in the existing manifold were leak points as well.

To ensure the fewest possible leak points, Clippard designed an acrylic diffusion-bonded manifold which not only eliminated the need for gaskets, but also allowed critical passages at tight tolerances. The special manifold allowed the new valves to be mounted together tightly and compactly, providing a leakproof solution with an even smaller footprint than the OEM had previously.



ELECTRONIC VALVES



"When our engineering team is working directly with the customer's engineering team—that is when Clippard's experience, creativity, and expertise are of most benefit to all involved."

JERRY GROTELUESCHEN

ENGINEERING MANAGER,
APPLICATION ENGINEERING GROUP

WHAT CAN CLIPPARD DO FOR YOU?

877-245-6247

DV SERIES HIGH FLOW VALVES

2-WAY & 3-WAY HIGH FLOW VALVES



- Industry standard for leak-free operation
- Design flexibility and fast response
- Designed to accommodate large flows with more stroke
- Robust stainless steel “spider”

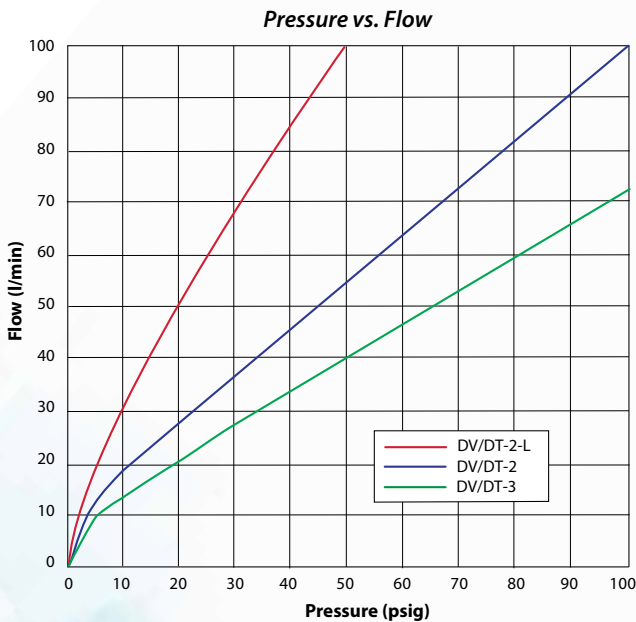

QUICK CONNECT

Clippard DT Series valves feature spade lugs for simple, quick secure low voltage connections. The DV type valves are available in popular voltages with 18" wire leads.

Clippard DV series electronic valves are high flow, precision-built control valves. This powerful series was designed as the next generation of the well-known and trusted original EV series valves. With a life of over a billion cycles, a solid, compact design, and extremely high flow rates, these valves are suitable for many applications across numerous diverse industries. A variety of voltage, connector and mounting options are available.

Proportional version also available—See p. 58-59

- Fast response
- Low heat rise/low power
- Small package
- Single moving part for low friction and wear
- Two orifice sizes
- Two connection styles
- Two mounting types

Medium	Air or compatible gases (40 micron filter)
Air Flow	DV-2/DT-2: 100 l/min @ 100 psig DV-2-L/DT-2-L: 100 l/min @ 50 psig DV-3/DT-3: 70 l/min @ 100 psig
Power Consumption	1.9 watts
Ports	#10-32 (on manifold mount valve)
Temperature Range	32 to 130° F
Response	10 to 15 ms
Electrical Connection	Spade terminals or wire leads
Operating Range	95 to 125% of rated voltage
Mounting	Manifold or cartridge style (inserts into a 3/4" bore)
Wetted Materials	PPS, PEI, stainless steel
Seal Material	FKM standard Nitrile, EPDM ¹ , and silicone ¹ available
More Details	clippard.com/link/dv

*Customizable to the specifications of the application. Call 1-877-245-6247.

¹Minimum order quantity required for EPDM or silicone seals

DV SERIES HIGH FLOW VALVES

2-WAY & 3-WAY VALVES, MANIFOLD & CARTRIDGE MOUNT

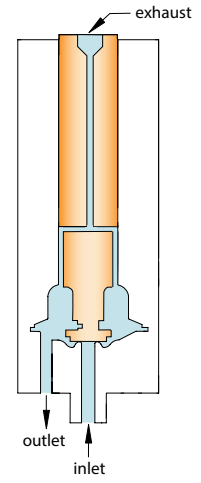
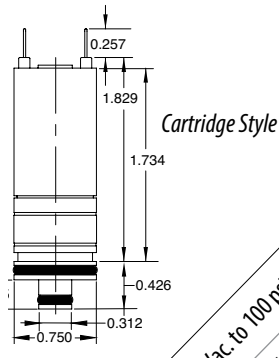
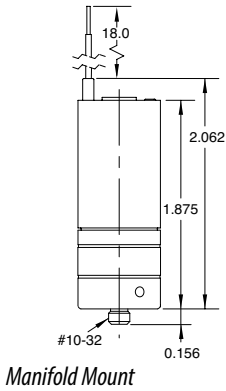

Vac. to 100 psig
 Vac. to 50 psig
 12 VDC
 24 VDC

	Pressure Range	Voltage	In-Line	Cartridge	In-Line	Cartridge
<p>Spade Terminals</p>	•	•	DT-2M-12	DT-2C-12	DT-3M-12	DT-3C-12
	•	•	DT-2M-24	DT-2C-24	DT-3M-24	DT-3C-24
	•	•	DT-2M-12-L	DT-2C-12-L		
	•	•	DT-2M-24-L	DT-2C-24-L		
<p>Wire Leads Top (Axial)</p>	•	•	DV-2M-12	DV-2C-12	DV-3M-12	DV-3C-12
	•	•	DV-2M-24	DV-2C-24	DV-3M-24	DV-3C-24
	•	•	DV-2M-12-L	DV-2C-12-L		
	•	•	DV-2M-24-L	DV-2C-24-L		

Medium	Air or compatible gases (40 micron filter)
Materials, Seals	FKM standard; nitrile, EPDM ¹ , and silicone ¹ available
Materials, Wetted	PPS, PEI, stainless steel
Mounting	Manifold or cartridge style
Operating Range	95 to 125% of rated voltage
Ports	#10-32 (on manifold mount valve)
Power Consumption	1.9 watts
Response Time	10 to 15 ms
Temperature Range	32 to 130°F
More Details	clippard.com/link/dv

See p. 10 for mounting option schematics

¹Minimum order quantity required for EPDM or silicone seals

Pressure Range	Version	Air Flow	Options Suffix
28" Hg Vac. to 100 psig	2-Way	100 l/min @ 100 psig	(blank)
	3-Way	70 l/min @ 100 psig	(blank)
28" Hg Vac. to 50 psig	2-Way	100 l/min @ 50 psig	-L

Options Suffix
Nitrile seals
FKM seals
EPDM seals ¹
Silicone seals ¹

Example Part Numbers:
 DV-2M-12-V

MULTI-STATION MANIFOLDS

Black anodized aluminum;
 1/8" NPT ports



Part No.	Description
15781-2	2-Station
15781-4	4-Station
15781-6	6-Station

SINGLE-STATION MANIFOLDS

ENP brass standard
 Other materials also available,
 call 877-245-6247.

Cartridge style shown



Part No.	Description
15490-5	Manifold Mount
15492-1	Cartridge Manifold

Clippard's Next Generation DV Series Valve

Clippard DV series electronic valves feature the same exceptional long life as the trusted EV series, but with even more flow! Proportional version also available (see pp. 58-59).

**For more details,
visit clippard.com/link/dv**

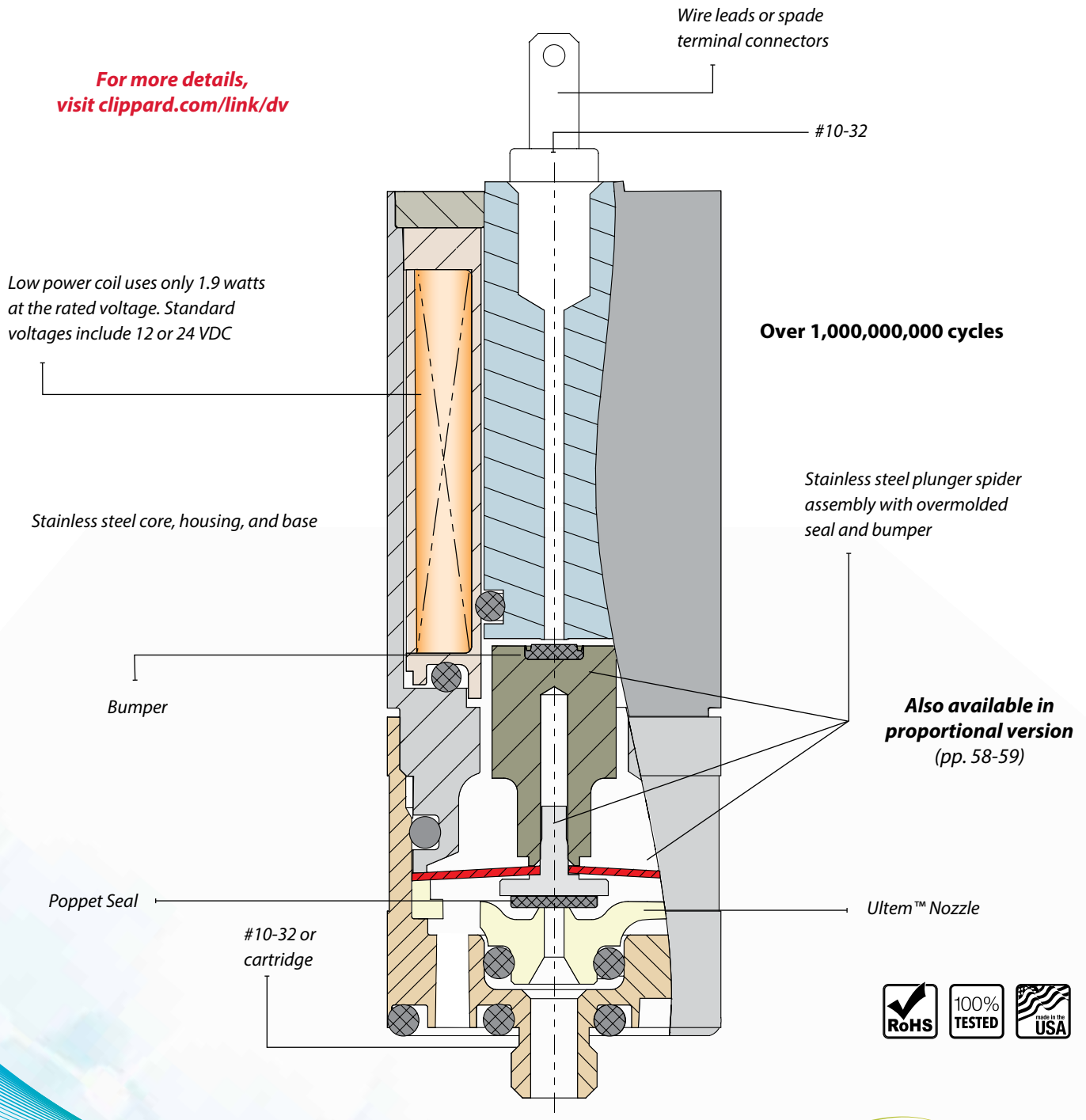

PROBLEM

Any component which fails prematurely presents obvious problems. Therefore, in an effort to reduce down time and costly maintenance, manufacturers often seek components with longer lifespans. In this case, the equipment required numerous high flow valves which were failing to provide sufficient longevity. Maintenance was becoming prohibitively costly as technicians were having to routinely replace valves, a process which, due to the size of the equipment, had to be performed on-site.



ELECTRONIC VALVES

SOLUTION

The OEM's primary concern was to reduce the costs required to maintain their equipment. The first step towards solving this was to replace the existing valves with Clippard DV valves. With a lifespan of over a billion cycles, this switch significantly reduced the number of service calls technicians had to make. As an added bonus, the new valves also provided lower power consumption and higher flow rates.

Along with the new DV valves, Clippard designed a special new manifold. With all the valves mounted together in a single, compact block, it became much quicker and easier to remove the entire valve system. This further reduced maintenance time by enabling technicians easier access to other components within the system.



WHAT CAN CLIPPARD DO FOR YOU?

877-245-6247

"The world is changing so fast now that you need the engineering support. And once you are in contact with Clippard's engineering team, Clippard is probably the most supportive engineering staff we deal with."

CUSTOMER TESTIMONIAL

EFB SERIES FILL & BLEED CIRCUITS

ELECTRONIC FILL & BLEED CIRCUITS

A fill and bleed circuit is a combination of pneumatic valve components used to inflate a volume or apparatus in one controllable function, and to release or vent pressure in a second controllable function.

- Extremely fast response
- Multiple flow and pressure options
- Compact, robust design with exceptionally long life

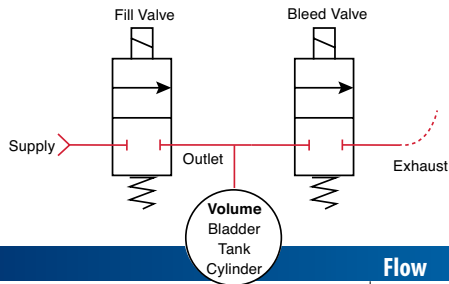

	Flow	Max. Pressure	Voltage	Part No.	Valve
In-Line Mount 	100 l/min @ 100 psig	•	•	EFB-1DV-12	DV-2M-12
		•	•	EFB-1DV-24	DV-2M-24
	80 l/min @ 50 psig	•	•	EFB-1DV-12-L	DV-2M-12-L
		•	•	EFB-1DV-24-L	DV-2M-24-L
	13 l/min @ 25 psig	•	•	EFB-1EM-12-H	EM-2-12-H
		•	•	EFB-1EM-24-H	EM-2-24-H
Manifold Mount 	17 l/min @ 100 psig	•	•	EFB-2EV-12	EV-2M-12
		•	•	EFB-2EV-24	EV-2M-24
	14 l/min @ 50 psig	•	•	EFB-2EV-12-L	EV-2M-12-L
		•	•	EFB-2EV-24-L	EV-2M-24-L
	13 l/min @ 25 psig	•	•	EFB-2EV-12-H	EV-2M-12-H
		•	•	EFB-2EV-24-H	EV-2M-24-H
	100 l/min @ 100 psig	•	•	EFB-2DV-12	DV-2M-12
		•	•	EFB-2DV-24	DV-2M-24
	100 l/min @ 50 psig	•	•	EFB-2DV-12-L	DV-2M-12-L
		•	•	EFB-2DV-24-L	DV-2M-24-L

MANIFOLD

Black anodized aluminum

Manifold Mount

In-Line Mount

For more details, visit clippard.com/link/efb

Part No.	Description	Notes
EFB-1M	In-Line Manifold Only	Specify your manifold mount DV, DT or EM valve when selecting the manifold only.
EFB-2M	Manifold Mount Manifold Only	Specify your manifold mount DV, DT, EV or EM valve when selecting the manifold only.

PROBLEM

Medical equipment manufacturers are often looking to design smaller, more portable systems. This presents unique challenges with regard to power requirements, size, and weight. Reliability can also be critical, as it can quite literally be a matter of life or death. Equipment being used in the field must not only be precise and accurate, but also robust and durable. These types of systems—and their components—must be designed and assembled to withstand rough handling, such as what might occur during an emergency situation or while treating a patient in the back of an ambulance or helicopter.

SOLUTION

The OEM's primary concern was to improve the overall accuracy and precision of their system, a problem which was easily solved by replacing select components with Clippard valves. Clippard then designed a special manifold which allowed the new valves to be mounted alongside the system's other components. This new all-in-one solution provided a significant reduction in leak points, thereby enhancing the system's overall reliability.

The new manifold provided a footprint which was so much smaller and more compact that it led the OEM to develop a new version of their own product. The new unit not only provided enhanced accuracy and precision, but was also smaller in size and lighter in weight.

WHAT CAN CLIPPARD DO FOR YOU?

877-245-6247



ELECTRONIC VALVES



"Clippard's responsiveness during the project has been phenomenal."

CUSTOMER TESTIMONIAL

HIT & HOLD CIRCUIT RECOMMENDATIONS

Hit and hold circuits allow valves to be held on for long periods of time at a lower voltage than their rated voltage. The general principle is that the valve is energized to full power for a short period of time before dropping the voltage and current to a specified level. In a typical hit and hold circuit, the hit is at the standard rated voltage for a specified period of time. The hold is usually 50% (or less) of the rated voltage. Here are some of our recommendations for designing successful hit and hold circuits using Clippard valves.

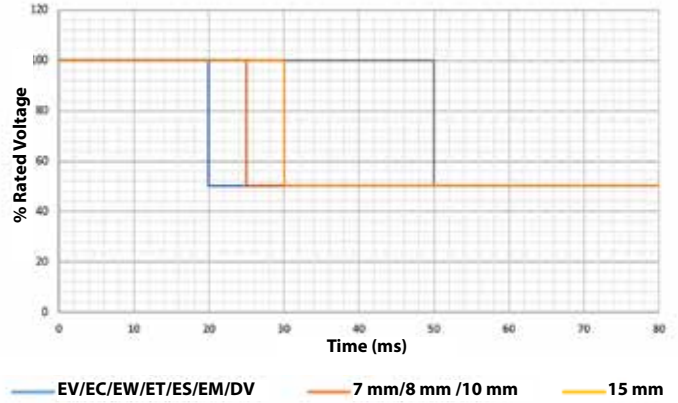

EV, ES, EM, AND DV VALVES

For our standard mouse valves, Clippard recommends hitting the valve with 100% of the rated voltage for 20 ms minimum, and then dropping the voltage to 50% of the rated value. If the valve is being used with reverse flow, the hit time may need to be extended depending on the pressure.

- EV Series (p. 4)
- ES (p. 23)
- EM Series (p. 22)
- DV Series (p. 32)

Example:

For a 12 VDC valve, hit the valve with 12 VDC for 20 ms, then drop the voltage to 6 VDC



7 MM (SV), 8 MM (ST), AND 10 MM VALVES

For our 7 mm, 8 mm, and 10 mm valves, Clippard recommends hitting the valve with 100% of the rated voltage for 25 ms minimum, and then dropping the voltage to 50% of the rated value.

- 7 mm SV Series (p. 29)
- 8 mm ST Series (p. 30)
- 10 mm (p. 40)

Example:

For a 12 VDC valve, hit the valve with 12 VDC for 25 ms, then drop the voltage to 6 VDC

15 MM VALVES

For our 15 mm manifold mounted valves, Clippard recommends hitting the valve with 100% of the rated voltage for 30 ms minimum, and then dropping the voltage to 50% of the rated value.

- 15 mm (p. 42)

Example:

For a 12 VDC valve, hit the valve with 12 VDC for 30 ms, then drop the voltage to 6 VDC



10 & 15 MM MINIATURE VALVES

All of the benefits of Clippard quality and reliability are available in these 10 mm and 15 mm miniature valves. Offered in both Normally-Open or Normally-Closed models, these 2-Way and 3-Way valves are perfect for small areas where compact electronically-controlled pneumatics are needed.

A high strength, engineered lightweight glass-filled nylon body—along with stainless steel, FKM and nitrile—makes this series suitable for a broad range of applications. With exceptional life and reliability, this versatile miniature valve is a smart choice for many types of systems across many different industries.



10 MM STANDARD

Direct operating valves well-suited for single- or multiple-valve mounting in small spaces.
(90° connector shown)



15 MM STANDARD

Direct operating valves well-suited for single- or multiple-valve mounting in small spaces.
(DIN connector shown)



10 MM LATCHING

A short pulse of current shifts this valve which “latches” indefinitely; another pulse returns the valve.
(Wire leads shown)



15 MM LATCHING

A short pulse of current shifts this valve which “latches” indefinitely; another pulse returns the valve.
(Wire lead shown)



10 MM HIGH FLOW 2-WAY

Specialty series for high flow applications.
(In-line connector shown)



15 MM HIGH FLOW 2-WAY

Specialty series for high flow applications.
(In-line connector shown)

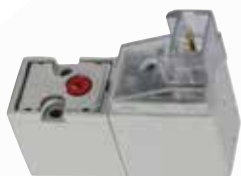

10 MM ISO 15218 SERIES

Conforms to ISO standard for mounting and port locations.
(90° connector shown)

Medium	Air, gas, or other compatible fluids
Material	Stainless steel core and springs, Nylon body, FKM dynamic seals, nitrile gasket and static seals
Electrical	The coil is constructed of copper wire and insulated according to the class "F" standard. All circuitry and connections are protected from corrosion
CE, RoHS Compliant	
More Details	clippard.com/link/10-15mm

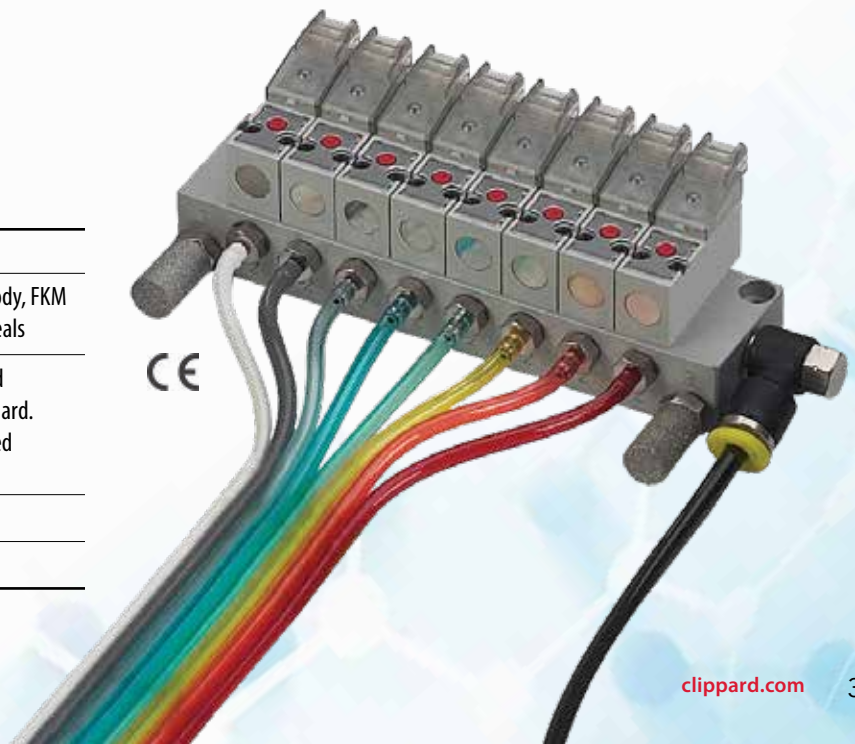

10 MM MINIATURE VALVES

LATCHING 10 MM MINIATURE VALVES

Clippard's Latching series features a careful balance of forces—through the precise placement of a permanent magnet in the valve core—produces a bi-stable valve. A short pulse of current opens the valve, which “latches” open indefinitely after the current stops. A subsequent pulse of current in the opposite direction closes the valve. The valve consumes less energy and produces less heat than a standard solenoid valve.

Working Pressure	0 to 110 psig
Max. Flow Rate	31.2 l/min @ 110 psig
Orifice	0.030"
Electrical Connection	2-Wire reverse polarity, 300 mm, 24 AWG
Wattage	2.0 watts
Voltage Tolerance	±10%
Connector	Wire leads



- 2-Way & 3-Way Normally-Closed configurations
- Pulse-actuated (on or off)
- Polarity reverse required
- Stable latch

Minimum order quantities may apply.

Type	Part No.	Voltage
2-Way	E2L10C-7W012	12 VDC
	E2L10C-7W024	24 VDC
3-Way	E3L10C-7W012	12 VDC
	E3L10C-7W024	24 VDC

HIGH FLOW 2-WAY 10 MM MINIATURE VALVES

Working Pressure	0 to 30 psig @ 30 psig
Max. Flow Rate	28 l/min
Orifice	0.055"
Power Consumption	3.5 watts in-rush phase; 15 ms/0.35 watts maintenance phase
Voltage Tolerance	±10%



10 MM HIGH FLOW SINGLE-STATION MANIFOLD

Spare hardware and cover plates available.

Part No.	Description
E10HM-01	10 mm Single-Station Manifold

Part No.	Connector	Voltage
E210H-3L012	90° Connector with LED	12 VDC
E210H-3L024		24 VDC
E210H-3C012	In-Line Connector with LED	12 VDC
E210H-3C024		24 VDC

90° Connector with LED



In-Line Connector with LED

ISO 15218 10 MM 3-WAY MINIATURE VALVES

Working Pressure	0 to 102 psig @ 102 psig
Maximum Flow Rate	42 l/min @ 102 psig
Exhaust Flow	49 l/min
Orifice	0.043"
Power Consumption	3.5 watts in-rush phase; 15 ms/0.35 watts maintenance phase
Voltage Tolerance	±10%



10 MM SINGLE-STATION ISO MANIFOLD

Spare hardware and cover plates available.

Part No.	Description
E10LM-01	ISO 10 mm Single-Station Manifold

Part No.	Connector	Voltage
E311E-3L012	90° Connector with LED	12 VDC
E311E-3L024		24 VDC
E311E-3C012	In-Line Connector with LED	12 VDC
E311E-3C024		24 VDC

In-Line Connector with LED



90° Connector with LED

10 MM MINIATURE VALVES

Medium	Air, gas, or other compatible fluids
Max. Flow Rate	0.020" Orifice: 14 l/min @ 110 psig 0.030" Orifice: 31.2 l/min @ 110 psig
Exhaust Flow	0.020" Orifice: 22.7 l/min @ 110 psig 0.030" Orifice: 34 l/min @ 110 psig
Response Time	8 ms when energized, 10 ms when de-energized
Voltage Tolerance	±10%
Power Consumption	0.6 or 1.3 watts <i>Dependent on orifice size and pressure</i>
Material	Stainless steel core and springs, nylon body, FKM dynamic seals, nitrile gasket and static seals
Coil Insulation Class	F 311°F
Temperature Range	23 to 122°F (If below 32°F, must use clean, dry air)
CE, RoHS Compliant	

Typical Air Flow

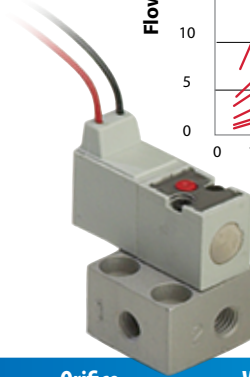
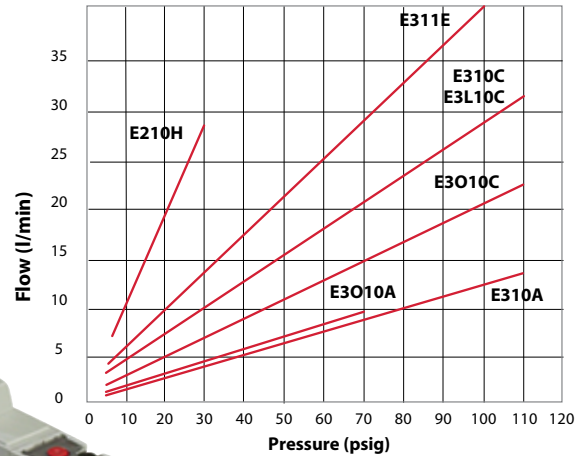

For more details, visit clippard.com/link/10-15mm

Type	Base Part No.*	Connector	Orifice	Wattage	Working Pressure
2-Way Normally-Closed 	E210A-1E □□□	90° Connector	0.020"	0.6 watts	14.7 to 110 psig
	E210C-2E □□□		0.030"	1.3 watts	0 to 110 psig
	E210A-1L □□□	90° Connector with LED	0.020"	0.6 watts	14.7 to 110 psig
	E210C-2L □□□		0.030"	1.3 watts	0 to 110 psig
	E210A-1F □□□	In-Line Connector	0.020"	0.6 watts	14.7 to 110 psig
	E210C-2F □□□		0.030"	1.3 watts	0 to 110 psig
	E210A-1C □□□	In-Line Connector with LED	0.020"	0.6 watts	14.7 to 110 psig
	E210C-2C □□□		0.030"	1.3 watts	0 to 110 psig
E210A-1W □□□	Wire Leads, 11.8"	0.020"	0.6 watts	14.7 to 110 psig	
E210C-2W □□□		0.030"	1.3 watts	0 to 110 psig	
3-Way Normally-Closed 	E310A-1E □□□	90° Connector	0.020"	0.6 watts	14.7 to 110 psig
	E310C-2E □□□		0.030"	1.3 watts	0 to 110 psig
	E310A-1L □□□	90° Connector with LED	0.020"	0.6 watts	14.7 to 110 psig
	E310C-2L □□□		0.030"	1.3 watts	0 to 110 psig
	E310A-1F □□□	In-Line Connector	0.020"	0.6 watts	14.7 to 110 psig
	E310C-2F □□□		0.030"	1.3 watts	0 to 110 psig
	E310A-1C □□□	In-Line Connector with LED	0.020"	0.6 watts	14.7 to 110 psig
	E310C-2C □□□		0.030"	1.3 watts	0 to 110 psig
E310A-1W □□□	Wire Leads, 11.8"	0.020"	0.6 watts	14.7 to 110 psig	
E310C-2W □□□		0.030"	1.3 watts	0 to 110 psig	
3-Way Normally-Open 	E3010A-1E □□□	90° Connector	0.020"	0.6 watts	14.7 to 70 psig
	E3010C-2E □□□		0.030"	1.3 watts	0 to 110 psig
	E3010A-1L □□□	90° Connector with LED	0.020"	0.6 watts	14.7 to 70 psig
	E3010C-2L □□□		0.030"	1.3 watts	0 to 110 psig
	E3010A-1F □□□	In-Line Connector	0.020"	0.6 watts	14.7 to 70 psig
	E3010C-2F □□□		0.030"	1.3 watts	0 to 110 psig
	E3010A-1C □□□	In-Line Connector with LED	0.020"	0.6 watts	14.7 to 70 psig
	E3010C-2C □□□		0.030"	1.3 watts	0 to 110 psig
E3010A-1W □□□	Wire Leads, 11.8"	0.020"	0.6 watts	14.7 to 70 psig	
E3010C-2W □□□		0.030"	1.3 watts	0 to 110 psig	

*Add voltage choice to the end of each base part number
12 VDC (012) or 24 VDC (024), Example: E210A-1C012

15 MM MINIATURE VALVES

CONNECTOR OPTIONS

Terminal Connector



Industrial form C connector ordered separately (p. 44)

DIN Connector



DIN connector ordered separately (p. 44)

In-Line Connector with LED



90° Connector with LED



Wire Leads



LATCHING 15 MM MINIATURE VALVES

Through the precise placement of a permanent magnet in the valve core, a careful balance of forces produces a bi-stable valve. A short pulse of current to the brown lead opens the valve, which “latches” open indefinitely after the current stops. A subsequent pulse of current to the blue lead closes the valve. The valve consumes less energy and produces less heat than a standard solenoid valve.

- Max. Flow Rate** **0.043” Orifice:** 59 l/min @ 150 psig
 0.063” Orifice: 84 l/min @ 110 psig
- Electrical Connection** 3-Wire molded cord, 300 mm, 24 AWG 4.5 mm external jacket; tinned copper wires; silicone jacket and conductor insulation
- Voltage Tolerance** ±10%
- Wattage** 4.0 watts

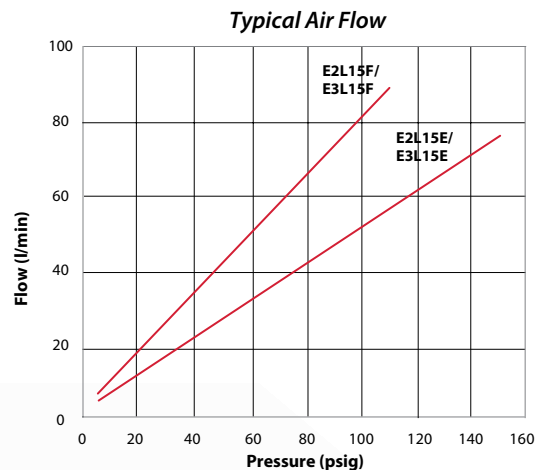

Type	Part No.	Orifice	Voltage	Pressure
2-Way	E2L15E-4W012	0.043"	12 VDC	0 to 150 psig
	E2L15E-4W024	0.043"	24 VDC	0 to 150 psig
	E2L15F-4W012	0.063"	12 VDC	0 to 110 psig
	E2L15F-4W024	0.063"	24 VDC	0 to 110 psig
3-Way	E3L15E-4W012	0.043"	12 VDC	0 to 150 psig
	E3L15E-4W024	0.043"	24 VDC	0 to 150 psig
	E3L15F-4W012	0.063"	12 VDC	0 to 110 psig
	E3L15F-4W024	0.063"	24 VDC	0 to 110 psig



- 2-Way & 3-Way Normally-Closed configurations
- Pulse-actuated (on or off)
- 3-wire coil—no polarity reverse required
- Stable latch
- Minimum order quantities may apply

HIGH FLOW 2-WAY N.C. 15 MM VALVES

- Working Pressure** 0 to 43 psig
- Maximum Flow Rate** 120 l/min @ 43 psig
- Orifice** 0.118"
- Voltage Tolerance** ±10%
- Power Consumption** 4.0 watts

Part No.	Connector	Voltage
E215H-3L012	90° Connector	12 VDC
E215H-3L024	with LED	24 VDC
E215H-3C012	In-Line Connector	12 VDC
E215H-3C024	with LED	24 VDC



15 MM HIGH FLOW SINGLE-STATION MANIFOLD

Spare hardware and cover plates available.

Part No.	Description
E15HM-01	15 mm Single-Station Manifold

90° Connector with LED



In-Line Connector with LED



15 MM MINIATURE VALVES

Medium	Air, gas, or other compatible fluids
Max. Flow Rate	0.032" Orifice: 45 l/min @ 150 psig 0.043" Orifice: 70 l/min @ 150 psig 0.063" Orifice: 91 l/min @ 110 psig
Response Time	10 ms when energized; 12 ms when de-energized
Voltage Tolerance	±10%
Power Consumption	1.0 or 2.5 watts <i>Dependent on orifice size and pressure</i>
Material	Stainless steel core and springs, nylon body, FKM seals, nitrile gasket
Coil Insulation Class	F 311°F
Temperature Range	23 to 122°F (If below 32°F, must use clean, dry air)
More Details	clippard.com/link/10-15mm

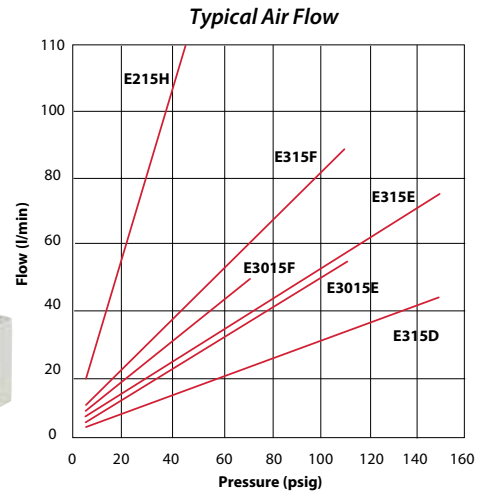

Type	Base Part No.*	Connector	12 24 24 110 220					Orifice	Wattage	Working Pressure
			VDC	VDC	VAC	VAC	VAC			
2-Way Normally-Closed 	E215D-1T □□□□	Terminal	•	•				0.032"	1.0	0 to 150 psig
	E215E-2T □□□□		•	•	•			0.043"	2.5	0 to 150 psig
	E215F-2T □□□□		•	•	•			0.063"	2.5	0 to 110 psig
	E215D-1D □□□□	DIN Connector	•	•				0.032"	1.0	0 to 150 psig
	E215E-2D □□□□		•	•	•	•		0.043"	2.5	0 to 150 psig
	E215F-2D □□□□		•	•	•	•	•	0.063"	2.5	0 to 110 psig
	E215D-1W □□□□	Wire Leads, 11.8"	•	•				0.032"	1.0	0 to 150 psig
	E215E-2W □□□□		•	•	•			0.043"	2.5	0 to 150 psig
	E215F-2W □□□□		•	•	•			0.063"	2.5	0 to 110 psig
E215D-1L □□□□	90° Connector with LED	•	•				0.032"	1.0	0 to 150 psig	
E215E-2L □□□□		•	•				0.043"	2.5	0 to 150 psig	
E215F-2L □□□□		•	•				0.063"	2.5	0 to 110 psig	
E215D-1C □□□□	In-Line Connector with LED	•	•				0.032"	1.0	0 to 150 psig	
E215E-2C □□□□		•	•				0.043"	2.5	0 to 150 psig	
E215F-2C □□□□		•	•				0.063"	2.5	0 to 110 psig	
3-Way Normally-Closed 	E315D-1T □□□□	Terminal	•	•				0.032"	1.0	0 to 150 psig
	E315E-2T □□□□		•	•	•			0.043"	2.5	0 to 150 psig
	E315F-2T □□□□		•	•	•			0.063"	2.5	0 to 110 psig
	E315D-1D □□□□	DIN Connector	•	•				0.032"	1.0	0 to 150 psig
	E315E-2D □□□□		•	•	•	•		0.043"	2.5	0 to 150 psig
	E315F-2D □□□□		•	•	•	•	•	0.063"	2.5	0 to 110 psig
	E315D-1W □□□□	Wire Leads, 11.8"	•	•				0.032"	1.0	0 to 150 psig
	E315E-2W □□□□		•	•	•			0.043"	2.5	0 to 150 psig
	E315F-2W □□□□		•	•	•			0.063"	2.5	0 to 110 psig
E315D-1L □□□□	90° Connector with LED	•	•				0.032"	1.0	0 to 150 psig	
E315E-2L □□□□		•	•				0.043"	2.5	0 to 150 psig	
E315F-2L □□□□		•	•				0.063"	2.5	0 to 110 psig	
E315D-1C □□□□	In-Line Connector with LED	•	•				0.032"	1.0	0 to 150 psig	
E315E-2C □□□□		•	•				0.043"	2.5	0 to 150 psig	
E315F-2C □□□□		•	•				0.063"	2.5	0 to 110 psig	
3-Way Normally-Open (110 psig max.) 	E3015E-2T □□□□	Terminal	•	•	•			0.043"	2.5	0 to 110 psig
	E3015F-2T □□□□		•	•	•			0.063"	2.5	0 to 75 psig
	E3015E-2D □□□□	DIN Connector	•	•	•	•		0.043"	2.5	0 to 110 psig
	E3015F-2D □□□□		•	•	•	•	•	0.063"	2.5	0 to 75 psig
	E3015E-2W □□□□	Wire Leads, 11.8"	•	•	•			0.043"	2.5	0 to 110 psig
	E3015F-2W □□□□		•	•	•			0.063"	2.5	0 to 75 psig
	E3015E-2L □□□□	90° Connector with LED	•	•				0.043"	2.5	0 to 110 psig
	E3015F-2L □□□□		•	•				0.063"	2.5	0 to 75 psig
	E3015E-2C □□□□	In-Line Connector with LED	•	•				0.063"	2.5	0 to 110 psig
E3015F-2C □□□□	•		•				0.063"	2.5	0 to 75 psig	

*Add voltage choice to end of base part number: 12 VDC (012), 24 VDC (024), 24 VAC (24A), 110 VAC (110), or 220 VAC (220). Example: E315D-1C012

10 & 15 MM MANIFOLDS, COVER PLATES & CONNECTORS

STANDARD MANIFOLDS

Standard manifolds are available for one to 16 valves with ported exhaust. Spare hardware and cover plates also available.



10 mm	15 mm	Description
E10M-01	E15M-01	Single-Station Manifold
E10M-02	E15M-02	2-Station Manifold
E10M-04	E15M-04	4-Station Manifold
E10M-06	E15M-06	6-Station Manifold
E10M-08	E15M-08	8-Station Manifold
E10M-10	E15M-10	10-Station Manifold
E10M-12	E15M-12	12-Station Manifold
E10M-14	E15M-14	14-Station Manifold
E10M-16	E15M-16	16-Station Manifold

COVER PLATES

Includes plate, gasket and two screws.

Part No.	Description
E10M-CP	10 mm Cover Plate
E15M-CP	15 mm Cover Plate



CONNECTORS

Wire connector must be ordered separately. 24 AWG. Stranding 7/32.

Part No.	Description
C2A-RB300	Connector with Cable, 11.8"
C2A-RB500	Connector with Cable, 19.7"
C2A-RB1000	Connector with Cable, 39.4"

MINIATURE MANIFOLDS

Small, compact manifolds provide efficient grouping of 10 or 15 mm valves and enable quick, easy installation. Each manifold features a common inlet, individually ported outlets, and exhaust to atmosphere.

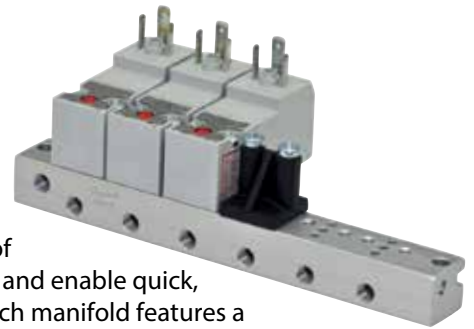

10 mm	15 mm	Description	Supply Ports
E10SM-02	E15SM-02	2-Station Manifold	1
E10SM-04	E15SM-04	4-Station Manifold	1
E10SM-06	E15SM-06	6-Station Manifold	1
E10SM-08	E15SM-08	8-Station Manifold	1
E10SM-10	E15SM-10	10-Station Manifold	2
E10SM-12	E15SM-12	12-Station Manifold	2
E10SM-14	E15SM-14	14-Station Manifold	2
E10SM-16	E15SM-16	16-Station Manifold	2

Note: When using these multi-station manifolds with Normally-Open valve configurations, they cannot be used with Normally-Closed valves on the same manifold.

DIN CONNECTORS

For use with 15 mm valves only

DIN 43650 Form C connectors with 8 mm spade center spacing mate with the 15 mm DIN connector coil. Industrial Form connectors with 9.4 mm spade center spacing are designed to connect to 15 mm terminal coils. Both are available with or without surge suppression, and PVC molded three-wire cord set.

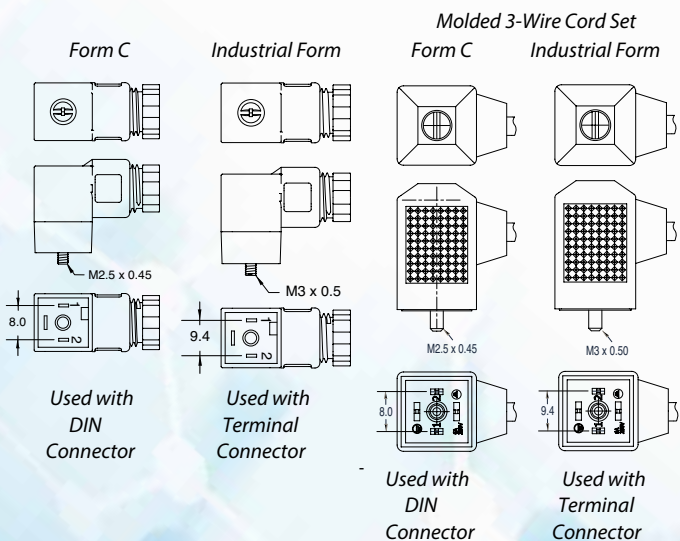

Form C Part No.	Industrial Form Part No.	Volts	LED	Cord
CC-C	CC-I	6-240	no	-
CC-C-P6	CC-I-P6	6-240	no	6'
CC-C-P15	CC-I-P15	6-240	no	15'
CC-CLL	CC-ILL	6-24	yes	-
CC-CLL-P6	CC-ILL-P6	6-24	yes	6'
CC-CLL-P15	CC-ILL-P15	6-24	yes	15'
CC-CLM	CC-ILM	48-110	yes	-
CC-CLM-P6	CC-ILM-P6	48-110	yes	6'
CC-CLM-P15	CC-ILM-P15	48-110	yes	15'

PROBLEM

In many situations, an existing supplier may be providing an adequate solution from a product standpoint, yet other aspects of the relationship leave much to be desired. Often, this is related to problems with deliverability. This particular application needed to handle a variety of different medicaments while maintaining a tight flow tolerance at a specific pressure. Additionally, the OEM needed the solution to fit the existing footprint within their equipment.

SOLUTION

Clippard was able to design a special assembly utilizing standard miniature 10 mm and 15 mm electronic valves to meet the requirements of this application. Using standard Clippard catalog products, the OEM was assured that the valves would always be available for quick delivery. This drop-in solution not only proved to be an excellent value, but also enhanced the performance of the OEM's system.



ELECTRONIC VALVES

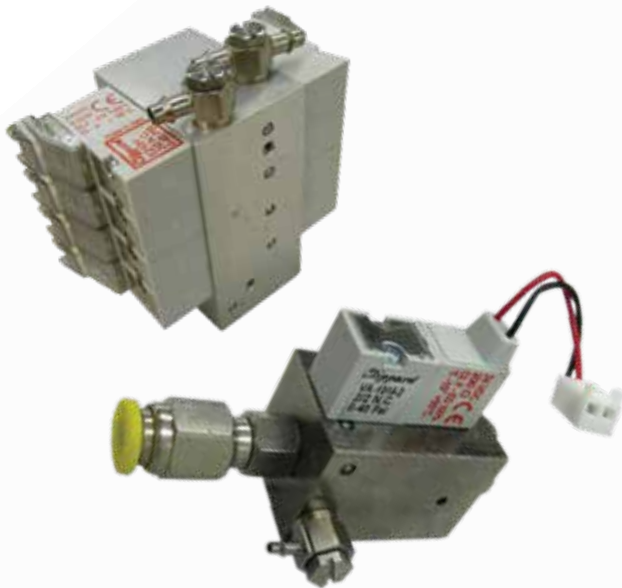

"Clippard's staff are great people—we have been working with them for years. That longevity speeds up problem solving because they know how the system works and can provide options to better solve particular issues."

CLIPPARD DISTRIBUTOR

WHAT CAN CLIPPARD DO FOR YOU?

877-245-6247

MAXIMATIC® SERIES SOLENOID-OPERATED VALVES

2-WAY, 3-WAY & 4-WAY VALVES

Available in 2-Way, 3-Way and 4-Way configurations in port sizes from #10-32 to 1/2" NPT. Select either a direct-acting poppet or solenoid-controlled pilot operated balanced spool design. Spool valves are body ported but can be bolted to a parallel circuit manifold. The 4-Way valves are also available in 3-position versions with either pressure center, closed center or exhaust center spool options.

Materials	Aluminum, stainless steel, thermoplastic
Max. Pressure	Spool Valves: 20 to 125 psig; Direct-Acting: 0 to 115 psig; MME-41 Series: 30 to 125 psig
Response Time	< 20 ms
Mounting	Manifold (standard), actuator (1/4") available
Manual Override	Locking or non-locking
Electrical Connection	DIN terminal with LED indicator, or 18" wire leads
DIN Connector	Plug-in electrical connector with LED, DIN 43650 Form "B" 3 mm screw; MME-31/41: DIN Industrial Form "C" (9.4 mm centers), 3 mm screw <i>Note: LED will not light if polarity is reversed</i>
Wire Leads	Not polarity sensitive
Temp. Range	32 to 150°F
Seals	Nitrile
More Details	clippard.com/link/max-solenoid



3-Way & 4-Way Valves

Port	Cv	Flow Rate	
		@ 50 psig	@ 100 psig
#10-32	0.58	450 l/min	760 l/min
1/8" NPT	0.67	510 l/min	880 l/min
1/4" NPT	0.89	740 l/min	1,400 l/min
3/8" NPT	1.68	1,400 l/min	2,600 l/min
1/2" NPT	2.79	2,600 l/min	4,800 l/min

- Small size makes valves ideal for use in compact applications
- Closed center, pressure center, and exhaust center models available

**MAXIMUM VALUE.
MAXIMUM PERFORMANCE.**

Choose either DIN connector with LED indicator or 18" wire lead connection. Both are rotatable and interchangeable.



Easily accessible locking or non-locking manual override switch

Conforms to ISO 19973-2 test standards

Port sizes from #10-32 to 1/2" NPT

All Maximatic® solenoid valves are IP 65 CE rating

Nitrile Seals

Standard models include a base that permits fast, secure mounting of electronic valves to a manifold for grouping in compact assemblies.

Operating ranges to 125 psig

Sturdy aluminum body withstands rough environments

MAXIMATIC® SERIES SOLENOID-OPERATED VALVES

ORDER GUIDE

Valve Series Electronic Air Pilot	Enter E A	<input type="text"/>
Valve Type 2-Way (direct-acting only) 3-Way 4-Way	Enter 2 3 4	<input type="text"/>
Body/Port Size Direct-Acting 1/8" NPT 1/8" NPT Stacking 1/4" NPT Spool Type #10-32 1/8" NPT 1/4" NPT 1/4" NPT 3/8" NPT 1/2" NPT	Enter P S Q 1N 1P 2Q 3Q 3W 4Z	<input type="text"/>
Primary/Secondary Actuator Air/Air Air/Spring Electronic Pilot/Elec. Pilot Electronic Pilot/Spring Direct Acting/Spring	Enter AA AS EE ES DS (2- or 3-Way, #10-32, 1/8", 1/4" only)	<input type="text"/>
Mounting Standard Manifold Actuator*	Enter (blank) B	<input type="text"/> <i>* Only available on 3- or 4-Way electronic valves. 1/4" NPT actuator.</i>
Spool Type 2-Position, Spool 3-Position, Closed Center 3-Position, Exhaust Center 3-Position, Pressure Center	Enter (blank) C E P	<input type="text"/> <i>Only available on 4-Way valves with "AA" or "EE" actuator. Standard manifold mount only.</i>
Electrical Connector DIN Connector Wire Leads (18")	Enter D W	<input type="text"/> <i>Only required on electronic valves</i>
Voltage 12 VDC 24 VDC 24 VAC 110 VAC 220 VAC	Enter 012 024 24A 110 220	<input type="text"/> <i>Only required on electronic valves</i>



Single solenoid electronic valves mounted on 8-station manifold

Note: This numbering schematic is shown for illustration purposes only. All possible configurations are not available. For standard models, see the products illustrated in this catalog.

ELECTRONIC VALVES

Example MM - -

Example MM E - 4 2Q ES - D 110

MAXIMATIC® SERIES SOLENOID-OPERATED VALVES

ORDER GUIDE

2-WAY VALVES

Series No.	Style	Inlet	Ports Outlet	Exhaust	Function	Cv	Flow @ 100 psig
MME-2PDS	Poppet	1/8" NPT	1/8" NPT	1/8" NPT	2/2	0.12	190 l/min
MME-2QDS	Poppet	1/4" NPT	1/4" NPT	1/4" NPT	2/2	0.12	190 l/min
MME-2SDS	Poppet	1/8" NPT	1/8" NPT	1/8" NPT	2/2	0.05	65 l/min

3-WAY VALVES

MME-3PDS	Poppet	1/8" NPT	1/8" NPT	1/8" NPT	3/2	0.12	190 l/min
MME-3QDS	Poppet	1/4" NPT	1/4" NPT	1/4" NPT	3/2	0.12	190 l/min
MME-3SDS	Poppet	1/8" NPT	1/8" NPT	1/8" NPT	3/2	0.05	65 l/min
MME-31NES	Spool	#10-32	#10-32	#10-32	3/2 NC	0.58	760 l/min
MME-31PES	Spool	1/8" NPT	1/8" NPT	1/8" NPT	3/2 NC	0.67	880 l/min
MME-32QES	Spool	1/4" NPT	1/4" NPT	1/8" NPT	3/2 NC	0.89	1,400 l/min
MME-33WES	Spool	3/8" NPT	3/8" NPT	1/4" NPT	3/2 NC	1.68	2,600 l/min
MME-34ZES	Spool	1/2" NPT	1/2" NPT	1/2" NPT	3/2 NC	2.79	4,800 l/min
MME-31NEE	Spool	#10-32	#10-32	#10-32	3/2	0.58	760 l/min
MME-31PEE	Spool	1/8" NPT	1/8" NPT	1/8" NPT	3/2	0.67	880 l/min
MME-32QEE	Spool	1/4" NPT	1/4" NPT	1/8" NPT	3/2	0.89	1,400 l/min
MME-33WEE	Spool	3/8" NPT	3/8" NPT	1/4" NPT	3/2	1.68	2,600 l/min
MME-34ZEE	Spool	1/2" NPT	1/2" NPT	1/2" NPT	3/2	2.79	4,800 l/min

4-WAY VALVES

Series No.	Style	Inlet	Ports Outlet	Exhaust	Function	Cv	Flow @ 100 psig	Spool Configuration		
								Closed Center	Exhaust Center	Pressure Center
MME-41NES	Spool	#10-32	#10-32	#10-32	5/2	0.58	760 l/min			
MME-41PES	Spool	1/8" NPT	1/8" NPT	1/8" NPT	5/2	0.67	880 l/min			
MME-42QES	Spool	1/4" NPT	1/4" NPT	1/8" NPT	5/2	0.89	1,400 l/min			
MME-43WES	Spool	3/8" NPT	3/8" NPT	1/4" NPT	5/2	1.68	2,600 l/min			
MME-44ZES	Spool	1/2" NPT	1/2" NPT	1/2" NPT	5/2	2.79	4,800 l/min			
MME-41NEE	Spool	#10-32	#10-32	#10-32	5/2	0.58	760 l/min			
MME-41PEE	Spool	1/8" NPT	1/8" NPT	1/8" NPT	5/2	0.67	880 l/min			
MME-42QEE	Spool	1/4" NPT	1/4" NPT	1/8" NPT	5/2	0.89	1,400 l/min			
MME-43WEE	Spool	3/8" NPT	3/8" NPT	1/4" NPT	5/2	1.68	2,600 l/min			
MME-44ZEE	Spool	1/2" NPT	1/2" NPT	1/2" NPT	5/2	2.79	4,800 l/min			
MME-41NEEC	Spool	#10-32	#10-32	#10-32	5/3	0.50	650 l/min	•		
MME-41PEEC	Spool	1/8" NPT	1/8" NPT	1/8" NPT	5/3	0.50	650 l/min	•		
MME-42QEEC	Spool	1/4" NPT	1/4" NPT	1/8" NPT	5/3	0.67	1,400 l/min	•		
MME-43WEEC	Spool	3/8" NPT	3/8" NPT	1/4" NPT	5/3	1.00	2,000 l/min	•		
MME-44ZEEC	Spool	1/2" NPT	1/2" NPT	1/2" NPT	5/3	1.68	2,600 l/min	•		
MME-41NEEP	Spool	#10-32	#10-32	#10-32	5/3	0.50	650 l/min			•
MME-41PEEP	Spool	1/8" NPT	1/8" NPT	1/8" NPT	5/3	0.50	650 l/min			•
MME-42QEEP	Spool	1/4" NPT	1/4" NPT	1/8" NPT	5/3	0.89	1,400 l/min			•
MME-43WEEP	Spool	3/8" NPT	3/8" NPT	1/4" NPT	5/3	1.00	2,000 l/min			•
MME-44ZEEP	Spool	1/2" NPT	1/2" NPT	1/2" NPT	5/3	1.68	2,600 l/min			•
MME-41NEEE	Spool	#10-32	#10-32	#10-32	5/3	0.50	650 l/min		•	
MME-41PEEE	Spool	1/8" NPT	1/8" NPT	1/8" NPT	5/3	0.50	650 l/min		•	
MME-42QEEE	Spool	1/4" NPT	1/4" NPT	1/8" NPT	5/3	0.89	1,400 l/min		•	
MME-43WEEE	Spool	3/8" NPT	3/8" NPT	1/4" NPT	5/3	1.00	2,000 l/min		•	
MME-44ZEEE	Spool	1/2" NPT	1/2" NPT	1/2" NPT	5/3	1.68	2,600 l/min		•	

MAXIMATIC® SERIES SOLENOID-OPERATED VALVES

2-WAY & 3-WAY 2-POSITION VALVES



MME-2SDS-D024

Maximatic direct-acting valves are single solenoid spring return, poppet type valves; available as either 2-Way or 3-Way configurations in 1/8" and 1/4" NPT port sizes. Hardware to stack multiple valves is included with each stacking valve (MME-3SDS and MME-2SDS). Includes two long screws, two short screw, one gasket, and two nuts. Coil included.

2-WAY OR 3-WAY DIRECT-ACTING

Medium	Air (40 micron filtration), inert gas or liquid
Operating Range	0 to 115 psig
Flow	65 l/min @ 100 psig
Electrical Connection	DIN connector with LED indicator (D) or 18" wire lead (W)
Voltage	12 VDC (012), 24 VDC (024), 24 VAC (24A), 110 VAC (110), or 220 VAC (220)
Power Consumption	6.5 watts
Number of Ports	2 or 3
Mounting	Body ported or stacking

Replacement stacking kits are available which include two long screws, two short screws, one gasket and two nuts.

Part No.	Description
27048	Replacement Stacking Kit

2-Way Valves		l/min*	3-Way Valves		Inlet	Outlet	Exhaust	l/min*	Coil Part No. ²
MME-2PDS-□□		190	MME-3PDS-□□		1/8" NPT	1/8" NPT	#10-32	65	27065-□□
MME-2SDS-□□ ¹		71	MME-3SDS-□□ ¹		1/8" NPT	1/8" NPT	#10-32	65	27065-□□
MME-2QDS-□□		190	MME-3QDS-□□		1/4" NPT	1/4" NPT	#10-32	65	27065-□□

Add electrical connection and voltage choices to the end of each base part number—**Example:** MME-2QDS-W220

*Based on flow @ 100 psig; ¹Stacking valve; ²Refer to Replacement Coil Chart, p. 51



MME-33WES-D110

MME-32QEE-D110

3-WAY SINGLE OR DOUBLE SOLENOID

Maximatic 3-Way electronic valves are either Normally-Closed single solenoid spring return, or double solenoid spool valves in #10-32 to 1/2" NPT port sizes.

Medium	Air (40 micron filtration) or inert gas
Operating Range	20 to 125 psig
Electrical Connection	DIN connector with LED indicator (D) or 18" wire lead (W)
Voltage	12 or 24 VDC (012 or 024), 24 VAC (24A), 110 VAC (110), or 220 VAC (220)
Number of Ports	3
Mounting	Body ported, manifold mount, actuator (1/4" NPT only) or NAMUR (3/8" NPT only) available
Manual Override	Non-locking on MME-31 Series; locking on all others
Power Consumption	2.5 watts on MME-31 series; 3 watts for all others

Single Solenoid Valves		Double Solenoid Valves		Inlet	Outlet	Exhaust	l/min*	Coil Part No. ²
MME-31NES-□□		MME-31NEE-□□		#10-32	#10-32	#10-32	760	27001-□□
MME-31PES-□□		MME-31PEE-□□		1/8" NPT	1/8" NPT	1/8" NPT	880	27001-□□
MME-32QES-□□		MME-32QEE-□□		1/4" NPT	1/4" NPT	1/4" NPT	1,400	27065-□□
MME-33WES-□□		MME-33WEE-□□		3/8" NPT	3/8" NPT	3/8" NPT	2,600	27065-□□
MME-34ZES-□□		MME-34ZEE-□□		1/2" NPT	1/2" NPT	1/2" NPT	4,800	27065-□□

Add electrical connection and voltage choices to the end of each base part number—**Example:** MME-34ZEE-W024

*Based on flow @ 100 psig; ²Refer to Replacement Coil Chart, p. 51

MAXIMATIC® SERIES SOLENOID-OPERATED VALVES

4-WAY 2-POSITION & 3-POSITION VALVES



4-WAY 2-POSITION, SINGLE OR DOUBLE SOLENOID

Maximatic 4-Way solenoid controlled, pilot operated valves are either single solenoid spring return or double solenoid spool valves in #10-32 thread to 1/2" NPT port sizes. Coil included.

Operating Range	20 to 125 psig
Electrical Connection	DIN connector with LED indicator (D) or 18" wire leads (W)
Voltage	12 VDC (012), 24 VDC (024), 24 VAC (24A), 110 VAC (110), or 220 VAC (220)
Number of Ports	5
Mounting	Body ported, manifold mount
Manual Override	Non-locking on MME-41 models; locking on all others
Power Consumption	2.5 watts on MME-41 models; 3 watts for all others

Single Solenoid Valves	Double Solenoid Valves	Inlet	Outlet	Exhaust	l/min*	Coil Part No. ²
MME-41NES-□□	MME-41NEE-□□	#10-32	#10-32	#10-32	27	27001-□□
MME-41PES-□□	MME-41PEE-□□	1/8" NPT	1/8" NPT	1/8" NPT	31	27001-□□
MME-42QES-□□	MME-42QEE-□□	1/4" NPT	1/4" NPT	1/8" NPT	49	27065-□□
MME-43WES-□□	MME-43WEE-□□	3/8" NPT	3/8" NPT	1/4" NPT	93	27065-□□
MME-44ZES-□□	MME-44ZEE-□□	1/2" NPT	1/2" NPT	1/2" NPT	171	27065-□□

Add electrical connection and voltage choices to the end of each base part number—**Example:** MME-43WEE-D110

*Based on flow @ 100 psig; ²Refer to Replacement Coil Chart, p. 51

4-WAY 3-POSITION, DOUBLE SOLENOID

Operating Range	30 to 125 psig MME-41 Series; 20 to 125 psig all others
Electrical Connection	DIN connector with LED indicator (D) or 18" wire leads (W)
Voltage	12 VDC (012), 24 VDC (024), 24 VAC (24A), 110 VAC (110), or 220 VAC (220)
Number of Ports	5
Mounting	Body ported, manifold mount
Manual Override	Non-locking on MME-41 series; locking on all others
Power Consumption	2.5 watts on MME-41 models; 3 watts for all others

Maximatic 4-Way double solenoid spring centered valves with closed center, pressure center or exhaust center spools are available from #10-32 thread to 1/2" NPT port sizes. Coil included.



Closed Center	Pressure Center	Exhaust Center	Inlet	Outlet	Exhaust	l/min*	Coil Part No. ²
MME-41NEEC-□□	MME-41NEEP-□□	MME-41NEEE-□□	#10-32	#10-32	#10-32	650	27001-□□
MME-41PEEC-□□	MME-41PEEP-□□	MME-41PEEE-□□	1/8" NPT	1/8" NPT	1/8" NPT	650	27001-□□
MME-42QEEC-□□	MME-42QEEP-□□	MME-42QEEE-□□	1/4" NPT	1/4" NPT	1/8" NPT	1,400	27065-□□
MME-43WEEC-□□	MME-43WEEP-□□	MME-43WEEE-□□	3/8" NPT	3/8" NPT	1/4" NPT	2,000	27065-□□
MME-44ZEEC-□□	MME-44ZEEP-□□	MME-44ZEEE-□□	1/2" NPT	1/2" NPT	1/2" NPT	2,600	27065-□□

Add electrical connection and voltage choices to the end of each base part number—**Example:** MME-41PEEP-W024

²Based on flow @ 100 psig; ²Refer to Replacement Coil Chart, p. 51

MAXIMATIC® SERIES SOLENOID-OPERATED VALVES

CONNECTORS, REPLACEMENT COILS & MANIFOLDS

DIN CONNECTORS

DIN 43650 Form B connectors with 11 mm spade center spacing. DIN type size 2, 3, and 4 Maximatic valves. Industrial Form connectors with 9.4 mm spade center spacing are designed to connect to 15mm terminal coils. Both are available with or without surge suppression and PVC molded three-wire cord set.



Form B Part No.	Industrial Form Part No.	Volts	LED	Cord
CC-B	CC-I			-
CC-B-P6	CC-I-P6	6-240	no	6'
CC-B-P15	CC-I-P15			15'
CC-BLL	CC-ILL			-
CC-BLL-P6	CC-ILL-P6	6-24	yes	6'
CC-BLL-P15	CC-ILL-P15			15'
CC-BLM	CC-ILM			-
CC-BLM-P6	CC-ILM-P6	48-110	yes	6'
CC-BLM-P15	CC-ILM-P15			15'
CC-BLH				-
CC-BLH-P6		208-240	yes	6'
CC-BLH-P15				15'

REPLACEMENT COILS

Replacement coils for solenoid valves are available in voltages from 12 VDC to 220 VAC with either DIN connector or 18" wire leads.

Description	2.5 Watt	3.0 Watt	6.5 Watt
	#10-32 & 1/8"	1/4", 3/8" & 1/2"	Direct-Acting
For Use with DIN Connectors	MME-31/41	MME-32-44	MME-2
12 VDC	27001-D012	27065-D012	27002-D012
24 VDC	27001-D024	27065-D024	27002-D024
110 VAC	27001-D110	27065-D110	27002-D110
220 VAC	27001-D220	27065-D220	27002-D220
24 VAC	27001-D24A	27065-D24A	27002-D24A
Wire Leads			
12 VDC	27001-W012	27065-W012	27002-W012
24 VDC	27001-W024	27065-W024	27002-W024
110 VAC	27001-W110	27065-W110	27002-W110
220 VAC	27001-W220	27065-W220	27002-W220
24 VAC	27001-W24A	27065-W24A	27002-W24A



Industrial Form, 2.5 W
#10-32 & 1/8"

Form B, 3.0 W
1/4", 3/8" & 1/2"

Form B, 6.5 W
Direct-Acting

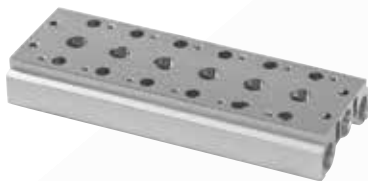

PARALLEL BAR MANIFOLDS

Parallel circuit manifold bars are supplied with mounting screws and gaskets. Spare kits are also available which include two screws and a gasket. Blank plate supplied with one gasket, two screws and metal plate.

Valve Series	Manifold Inlet/ Exhaust	Blank Plate	2-Station	4-Station	6-Station	8-Station	16-Station
3-Way Valve Manifolds							
MME-31	1/8"	MMM-31-B	MMM-31-02	MMM-31-04	MMM-31-06	MMM-31-08	MMM-31-16
MME-32	1/4"	MMM-32-B	MMM-32-02	MMM-32-04	MMM-32-06	MMM-32-08	MMM-32-16
MME-33	3/8"	MMM-33-B	MMM-33-02	MMM-33-04	MMM-33-06	MMM-33-08	MMM-33-16
MME-34	1/2"	MMM-34-B	MMM-34-02	MMM-34-04	MMM-34-06	MMM-34-08	MMM-34-16
3-Way Spare Mounting Kit Hardware							
27041-31	Hardware Kit for MME-31 Series Valves			27041-33	Hardware Kit for MME-33 Series Valves		
27041-32	Hardware Kit for MME-32 Series Valves			27041-34	Hardware Kit for MME-34 Series Valves		

Valve Series	Manifold Inlet/ Exhaust	Blank Plate	2-Station	4-Station	6-Station	8-Station	16-Station
4-Way Valve Manifolds							
MME-41	1/8"	MMM-41-B	MMM-41-02	MMM-41-04	MMM-41-06	MMM-41-08	MMM-41-16
MME-42	1/4"	MMM-42-B	MMM-42-02	MMM-42-04	MMM-42-06	MMM-42-08	MMM-42-16
MME-43	3/8"	MMM-43-B	MMM-43-02	MMM-43-04	MMM-43-06	MMM-43-08	MMM-43-16
MME-44	1/2"	MMM-44-B	MMM-44-02	MMM-44-04	MMM-44-06	MMM-44-08	MMM-44-16
4-Way Spare Mounting Kit Hardware							
27041-41	Hardware Kit for MME-41 Series Valves			27041-43	Hardware Kit for MME-43 Series Valves		
27041-42	Hardware Kit for MME-42 Series Valves			27041-44	Hardware Kit for MME-44 Series Valves		

Proportional Valves



EVP SERIES

- Fast response
- Long life
- Low friction and wear
- Flow proportional to input current

pp. 54-57



DVP SERIES

- Low hysteresis
- Fast response times
- Large flows in a small, sleek design
- Low heat rise
- Low power

pp. 58-59



SCPV SERIES

- 2% hysteresis
- Excellent linearity—2.5% of full-scale
- 2 ms reaction time
- Holds position for power savings or at a loss of power

pp. 60-61

Many items also available with metric ports.
For more information, visit clippard.com/link/metric

COMING SOON!

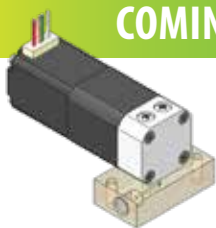

PROPORTIONAL ISOLATION SERIES

- *Specially designed for analytical and biomedical applications*
- *Precision control at low flow ranges*
- *Diaphragm isolation capability*
- *Low internal and dead volume*
- *Compact, low profile design*

p. 62

PROBLEM

Many types of medical and analytical applications require very precise gas metering. In this case, the customer was experiencing a variety of issues with their existing system. Technicians were having a hard time calibrating the system and overall, it was proving to be very unreliable. They were interested in exploring other options that might improve their system's performance.

SOLUTION

Utilizing the industry's most robust and powerful linear actuator, Clippard's high flow stepper-controlled proportional valve provides exceptional performance and durability. A trusted solution for critical gas delivery applications requiring high resolution, high flow, and low hysteresis, Clippard's SCPV series proved to be perfectly suited for this application.

A special benefit of the SCPV series is its unique design which allows for custom flow profiles. For this application, Clippard was able to determine a very specific needle taper that was ideal for this particular use. After applying the specialized profile, the modified SCPV valve was successfully integrated into a newly designed, more compact system. In addition to providing greater reliability, the final solution also proved to be more efficient and much easier to use.

WHAT CAN CLIPPARD DO FOR YOU?

877-245-6247



EVP SERIES MOUSE VALVES

2-WAY PROPORTIONAL VALVES



- Flow proportional to input current
- Fast response and long life
- Small, compact design
- Single moving part for low friction and wear
- Five orifice sizes
- Three connection styles
- Two mounting types

OPERATING PRESSURE

The EVP proportional valve can be calibrated for pressures less than the maximum pressure shown. Lower pressures may be substituted in increments of 5 psig, and will be used for calibration. For pressures less than 5 psig, call **877-245-6247**.

Note: Voltage, orifice, and pressure are determined by the part number (see p. 56).

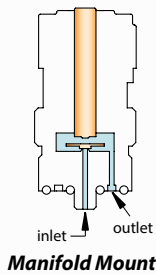
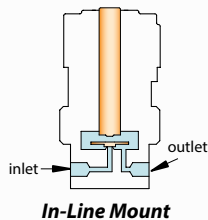

APPLICATIONS

- Analytical Instruments
- Blood pressure monitoring
- Precise pressure control
- Patient simulators
- Gas controllers
- Mass flow control
- Gas chromatography
- Respirators/ventilators

The EVP series proportional control valves combine the features of the existing EV series valve—long life, low power, and Clippard’s reputation for high quality components—with the additional capability for proportional control. The EVP series valve provides air or gas flow control and varies the output flow based on the current input to the solenoid.

Controllability and overall value are the main features of the EVP proportional valve series. The consistent gain (see chart) of this valve provides a high degree of control for many applications. The valve may be controlled using DC current, open or closed-loop control, and even PWM (pulse width modulation) to cover a broad range of applications.

Medium	Clean, dry air or inert gases
Power Consumption	1.9 watts @ 73°F 2.3 watts max.
Temp. Range	32 to 120°F
Ports	#10-32 Female (in-line) #10-32 Male stud (manifold) <i>See p. 20 for manifold options</i>
Seal Material	Nitrile standard FKM, EPDM, and others available
Max. Hysteresis	10% of full current
More Details	clippard.com/link/evp

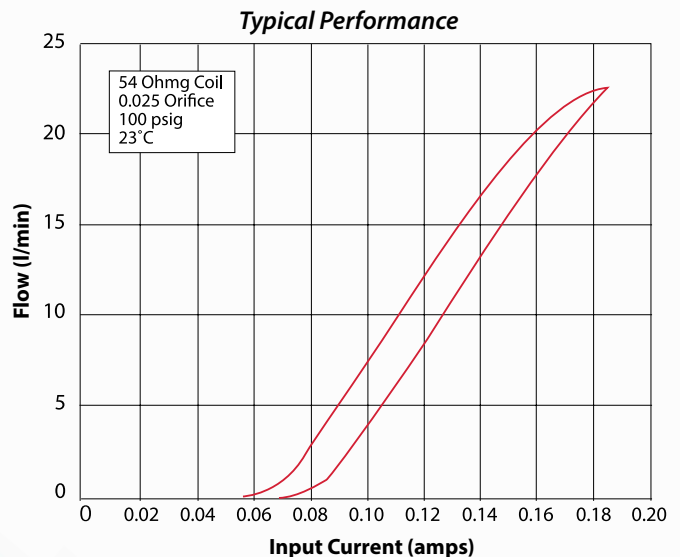

EVP Series Proportional Mouse Valves

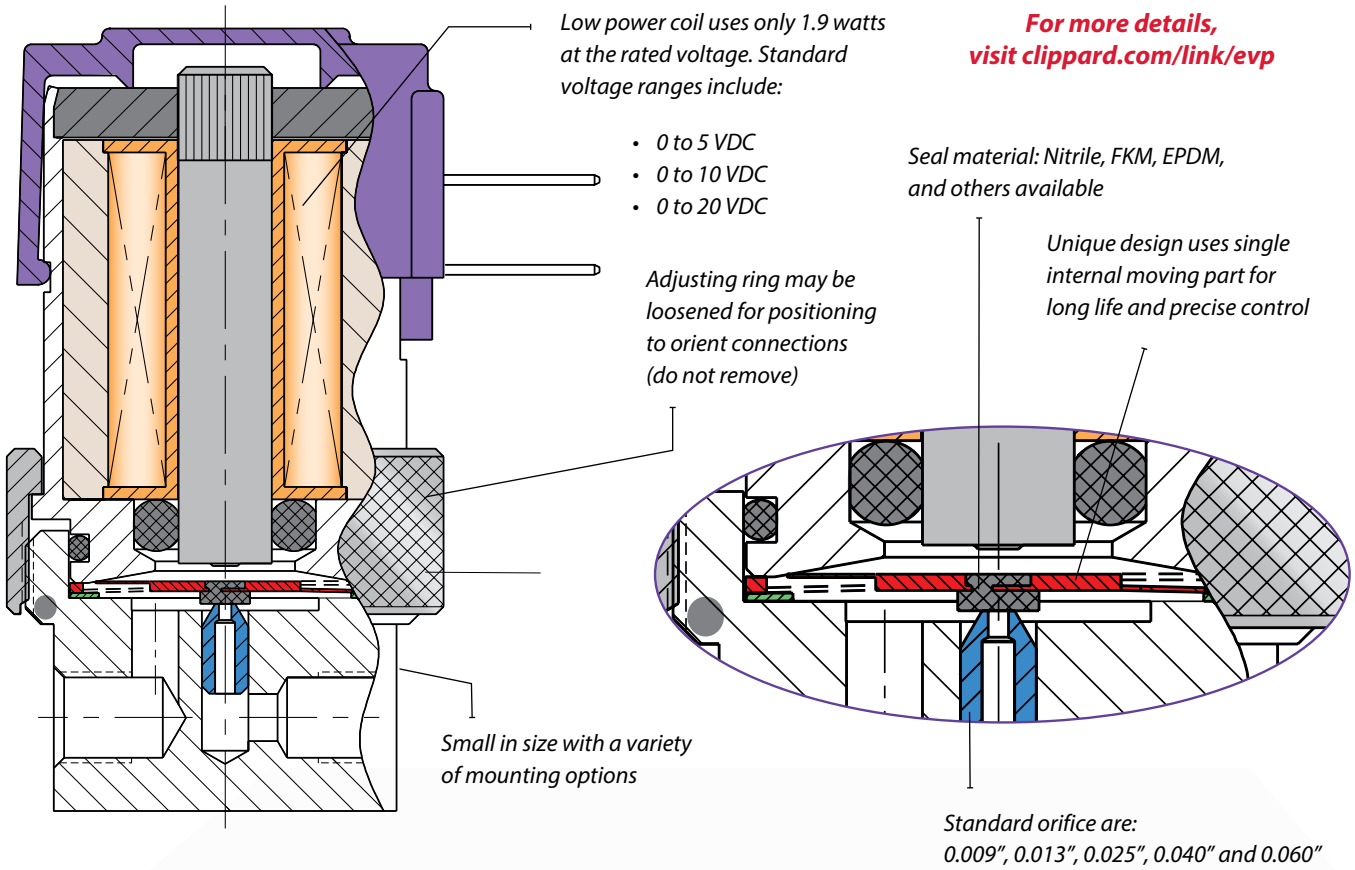

PROPORTIONAL VALVES

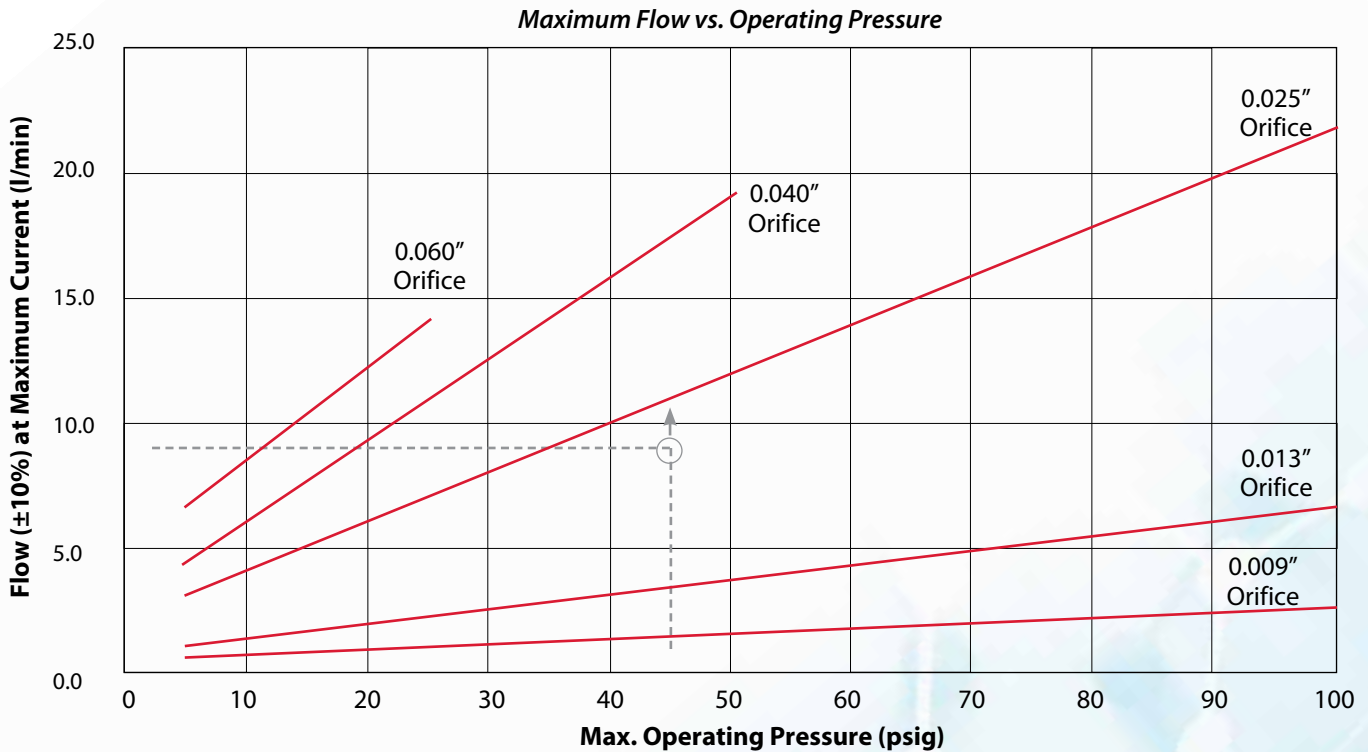

To determine the correct orifice required, locate the colored line immediately above the flow/pressure intersection
 Example: 9 slpm required at 45 psig inlet. This example leads to a "-2545" valve (0.025" nozzle, 45 psig).

EVP SERIES MOUSE VALVES

2-WAY PROPORTIONAL VALVES, IN-LINE & MANIFOLD MOUNT

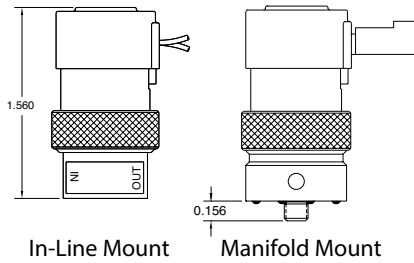

		Voltage			In-Line Mount	Manifold Mount
	 0.025" Pin Connector	•	•	•	EC-P-05-□□□□	EC-PM-05-□□□□
	 Spade Terminals	•	•	•	EC-P-10-□□□□	EC-PM-10-□□□□
		•	•	•	EC-P-20-□□□□	EC-PM-20-□□□□
	 Wire Leads Side (Radial)	•	•	•	ET-P-05-□□□□	ET-PM-05-□□□□
		•	•	•	ET-P-10-□□□□	ET-PM-10-□□□□
		•	•	•	ET-P-20-□□□□	ET-PM-20-□□□□
		•	•	•	EV-P-05-□□□□	EV-PM-05-□□□□
		•	•	•	EV-P-10-□□□□	EV-PM-10-□□□□
		•	•	•	EV-P-20-□□□□	EV-PM-20-□□□□

Operating Range & Orifice

When selecting your valve, there are many variables to choose from.

To choose the best valve for your application, focus on:

1. The control signal
2. Valve orifice
3. Operating pressure

Consult factory to discuss availability of non-standard voltages and other customization options.

Although the valves are listed by voltage, their flow is proportional to the current. It is crucial to specify and use a valve set to your operating pressure to assure optimal performance for your exact requirements. Proportional flow is achieved by varying the current input to the valve.

The EVP valve can be calibrated for pressures less than the maximum shown. Lower pressures may be substituted in increments of 5 psig, and will be used for calibration. The pressures shown are standard options. For pressures less than 5 psig or greater than the maximum pressure listed, please consult Clippard.

CONTROL SIGNAL

Nominal Voltage Range @ 72 °F (VDC)	Input Current Range (amps)	Coil Resistance @ 72 °F (ohms)	Max. Voltage Required (VDC)
0 to 5	0 to 0.370	13.5	6.2
0 to 10	0 to 0.185	54	12.4
0 to 20	0 to 0.092	218	24.8

Do not exceed input current range

STANDARD ORIFICES & FLOW

Orifice	Max. Flow (l/min)	Part No. Code	Max. Pressure
0.009"	2.7 ±10%	09	100 psig
0.013"	6.7 ±10%	13	100 psig
0.025"	22.0 ±10%	25	100 psig
0.040"	18.7 ±10%	40	50 psig
0.060"	14.0 ±10%	60	25 psig

Note: Max. flow is measured at max. pressure

ORDERING INFORMATION

Base Part No. → □ - □ - □ - □ ← Options

See chart above

Orifice* → □

Max. Pressure (5 psig to 100 psig) → □

In increments of 5, from 05 to 95

A0 100 psig

Options: (blank) Nitrile (standard), E EPDM¹, V FKM¹

Example Part Number: EC-P-05-0905-V

¹Min. order quantity required for EPDM or FKM seals

*See max. pressure in Standard Orifices & Flow chart above

EVP SERIES MOUSE VALVE DRIVER

PROPORTIONAL VALVE DRIVER



- Plug-and-play interface between Clippard's EVP and DVP series valves and PLCs or other controls
- Linearized valve response right "out of the box"
- Three selectable valve output ranges
- Five signal inputs to choose from
- Easy integration with existing machine controls
- User-adjustable parameters
- Automatic temperature compensation to maintain constant current
- Two configuration options: Stand-alone PCB or enclosed in housing
- Compact size

Power Requirements

Power input requirements are specified as supply voltage ranges for each EVP or DVP valve. Supplying voltages outside of these ranges may result in valve malfunctioning. Power requirements are determined by the valve voltage specification.

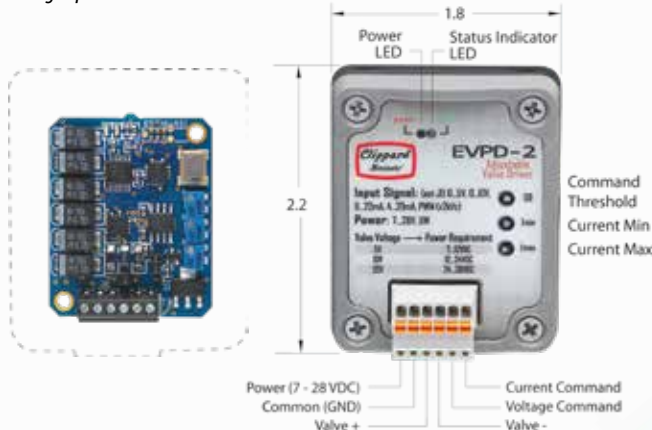
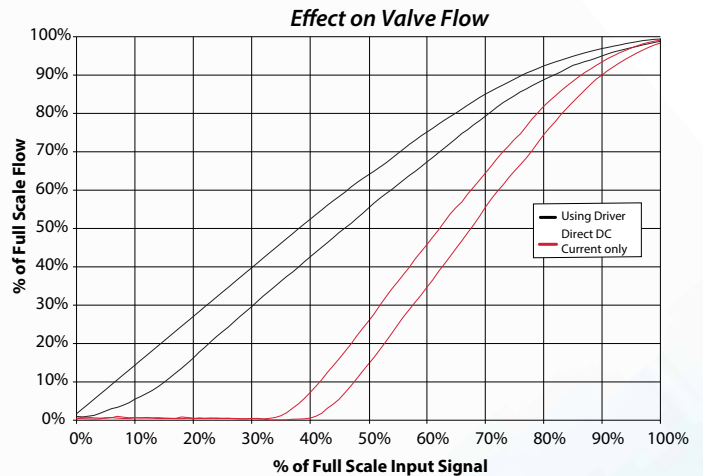

Figure 1: Effect of Driver Output on EVP or DVP Flow

The EVPD Proportional Valve Driver fast-tracks valve control applications. This product is ideal for laboratories and OEM product development, and can be customized to fit OEM applications including control parameters. The EVPD produces driver current for Clippard's EVP or DVP series valves proportional to input control signals.

Power Requirement	7 to 28 VDC @ 5 watt
Input Impedance	200 kΩ
Command Set-Point Signal Type	Selectable: 0 to 5 VDC, 0 to 10 VDC, 0 to 20 mA, 4 to 20 mA, PWM @ ≥ 2 kHz duty cycle
Adjustments	Min. drive current, max. drive current, command deadband
LED Indicators	Power, activity status, and faults
Output	0 to 0.4 (selectable range)
Temperature Range	0 to 155°F
Size	Open card: 1.5" x 1.3" x 0.4" unmounted Enclosed: 2.2" x 1.8" x 0.7" excluding DIN clip
More Details	clippard.com/link/evpd



EVP Valve Type	Input Voltage Range	EVPD Max. Output*
0 to 5 VDC	7 to 12 VDC	400 mA
0 to 10 VDC	12 to 28 VDC	200 mA
0 to 20 VDC	14 to 28 VDC	100 mA

*See EVP/DVP valve current requirements

Part No.	Description
EVPD-2	EVPD Driver Assembly in Enclosure
EVPD-1	EVPD Driver Board
EVPD-2DIN	DIN Rail Mounting Clip (shown at right) with screws



DVP SERIES HIGH FLOW VALVES

2-WAY PROPORTIONAL VALVES, MANIFOLD MOUNT



Clippard’s DVP series proportional solenoid valves are precision-built 2-Way control valves. This powerful series was designed as the next generation of the well-known and trusted original EV line of Clippard “Mouse” valves. With a life of over a billion cycles, a solid, compact design, and extremely high flow rates, these valves are suitable for many applications across numerous industries.

Controllability and overall value are the main features of the DVP series. The DVP valve provides air or gas flow control and varies the output flow based on the current input to the solenoid. The valve’s consistent gain (see chart) provides a high degree of control. It may be controlled using DC current, open or closed-loop control, and even pulse width modulation (PWM) to cover a large range of applications.

Typical Performance

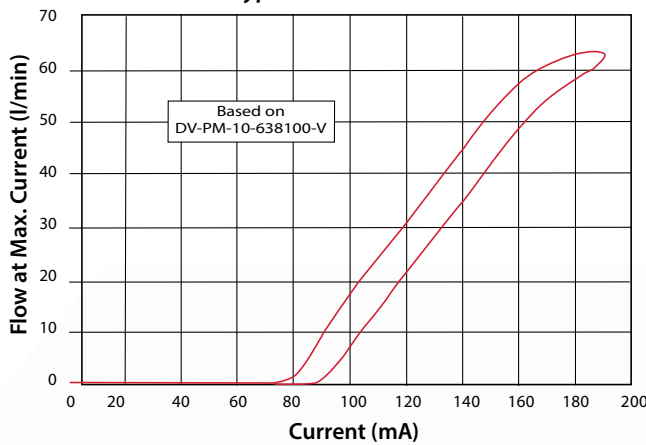

DVP Flow Capabilities

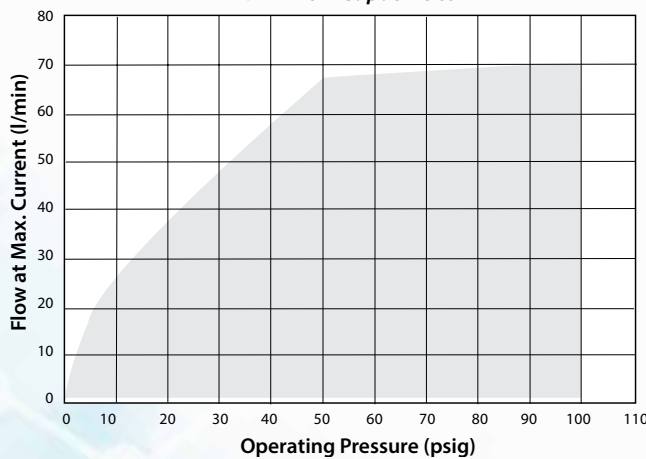

- Industry standard for leak-free operation
- Over 1,000,000,000 cycles
- Extremely low hysteresis
- Fast response time
- Large flows in small, sleek design
- Low heat rise/low power
- Robust stainless steel “spider” flat armature spring

Valve Type	2-Way, Proportional
Medium	Air or compatible gases (40 micron filter)
Pressure Range	Vac* to 100 psig
Max. Hysteresis	10% of full current
Max. Flow Tolerance	+10% / -0%
Power Consumption	1.9 watts at 72°F, 2.5 watts max.
Temperature Range	32 to 120°F
Voltage	10 or 20 VDC
Mounting	Manifold, #10-32 male stud
Seal Material	FKM standard Nitrile, EPDM, and silicone available
Wetted Materials	Stainless steel, PPS
Certifications	CE, RoHS, REACH
More Details	clippard.com/link/dvp

*Vacuum applications are reverse flow

For custom flow and pressure configurations, call 877-245-6247



DVP SERIES VALVES & MANIFOLDS

MANIFOLDS & ADDITIONAL INFORMATION

In selecting your valve, reference the **DVP Flow Chart** (opposite, p. 58) and list your nominal operating pressure in a 3-digit format (065 = 65 psig). Next, specify your desired max. flow rate for your pressure (500 = 50.0 l/min). Accurately specify your nominal operating pressure and flow to assure the best performance and resolution for your application. For nominal operating pressure under 5 psig, use a 005 designator for pressure. For vacuum applications use the positive pressure equivalent and reverse the ports.

Although the valves are listed by voltage, their flow is proportional to the current. It is crucial to specify and use a calibrated valve that matches your application. To assure you have optimal performance, be sure to use a valve set to your operating pressure. Proportional flow is achieved by varying the current input to the valve.

For more details, visit clippard.com/link/dvp



PROPORTIONAL VALVES

Nominal Voltage Range @ 72° F	Input Current Range	Coil Resistance @ 72° F	Max. Voltage Required
0 to 10 VDC	0 to 0.190 amps	52.6 ohms	13 VDC
0 to 20 VDC	0 to 0.095 amps	210.5 ohms	26 VDC

ORDERING INFORMATION

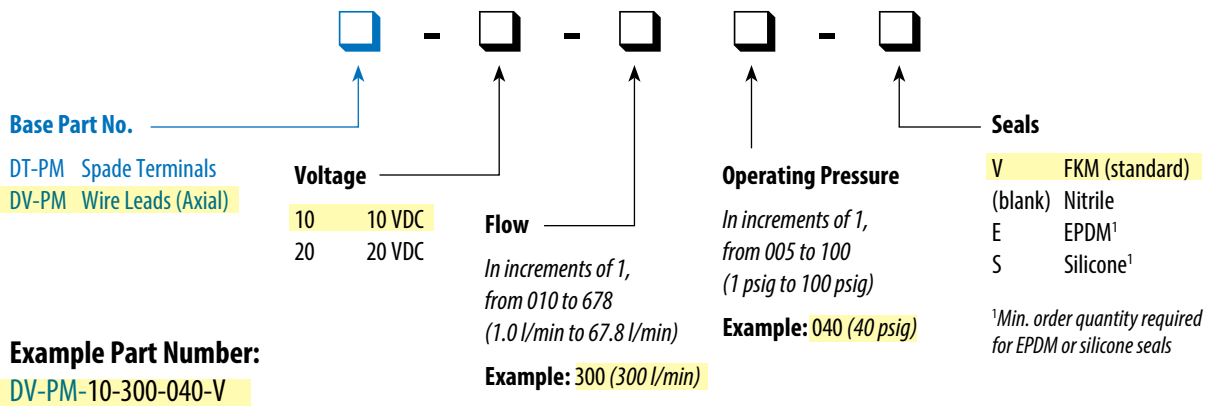

DVP valves are equipped with a bottom stud, 5/32" long with #10-32 thread, which fits Clippard standard and special manifolds, accessory valves and subplates. Spanner holes in the valve body permit tightening.

Call 877-245-6247 to discuss non-standard voltages and other options.

SINGLE-STATION MANIFOLDS

Material ENP Brass
Other materials also available, call 877-245-6247.

Part No.	Description
15490-5	Single-Station Manifold



MULTI-STATION MANIFOLDS

Material Black anodized aluminum
Ports 1/8" NPT

Part No.	Description
15781-2	2-Station Manifold
15781-4	4-Station Manifold
15781-6	6-Station Manifold



STEPPER-CONTROLLED SCPV SERIES

2-WAY PROPORTIONAL VALVES



Characteristic Curve

Flow Rate for SCPV-1-3 @ 100 psig

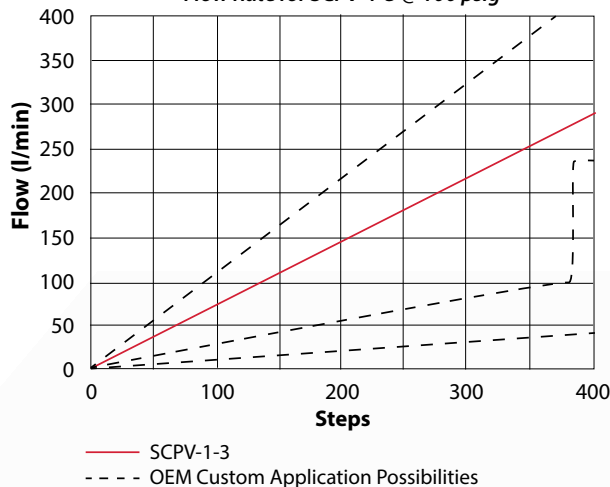

Part No.	Description
----------	-------------

SCPV-1-3	Proportional Valve, In-Line
SCPV-1-3M	Proportional Valve, Manifold
SCPV-1-3C	Proportional Valve, Cartridge

Stepper-controlled linear actuator with acme lead screw

Brass housing and internals

Anodized aluminum body

Acetal seat

1/8" NPT inlet & outlet ports (SCPV-1-3)

Customizable stainless steel needle

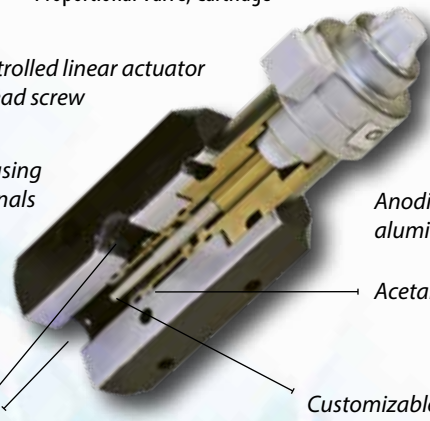

Utilizing the industry's most robust and powerful linear actuator, the high flow stepper-controlled proportional valve outperforms the competition in performance and durability. The SCPV valve is ideal in critical applications such as gas delivery, medical, analytical, and industrial automation requiring high resolution, high flow, and low hysteresis. In addition, the unique design allows for custom flow profiles when required.

- Less than 2% hysteresis
- Excellent linearity—less than 2.5% of full-scale
- 2 ms reaction time
- Millions of cycles
- Holds position for power savings or at a loss of power

Medium	Air or compatible gases
Typical Cycle Time for Full Travel	0.95 seconds @ 100% duty cycle 0.55 seconds @ 25% duty cycle <i>(full open to full close or full close to full open)</i>
Wetted Material	Stainless steel, aluminum, brass, acetal, and FKM*
Pressure Range	Vac to 100 psig*
Flow Range	0 to 280 l/min <i>Special configurations over 500 l/min available*</i>
Flow Resolution	0.7 l/min per step
Position Resolution	0.001" per step
Temperature Range	32 to 184°F
Driver	Bipolar chopper drive required
Needle	3.5°
Supply Voltage to Motor	5 VDC
Response Time	0.95 seconds fully-open to fully-closed
Mounting	In-line, manifold, or cartridge
Power Consumption	3.85 watts nominal only during adjustment Zero power consumption to maintain position
Seals	FKM standard, others available*
Option	Rubber seat <i>(add -R suffix)</i>
More Details	clippard.com/link/scpv

*This product is highly modifiable for OEM applications—including alternate body materials, flow profiles, and more. Clippard has successfully produced special configurations of the SCPV with flows over 700 slpm at 100 psig. Call 877-245-6247 today to discuss your needs.

STEPPER-CONTROLLED SCPV SERIES & DRIVER

PROPORTIONAL VALVE

LINEAR ACTUATOR CHARACTERISTICS

Wiring	Bipolar
Current/Phase	385 mA
Motor Voltage	5 VDC
Resistance/Phase	13 ohms
Inductance/Phase	8.08 mH
Power Consumption	3.85 watts
Temperature Rise	135°F
Insulation Resistance	20M ohms

Wiring Harness (included)

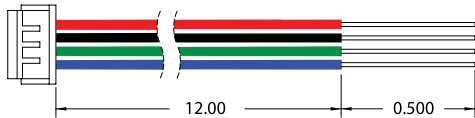

Pin	Color	Pin	Color
1	Red (A+)	3	Green (B-)
2	Black (A-)	4	Blue (B+)

Maximum Step Pulse Frequency vs. Operating Pressure

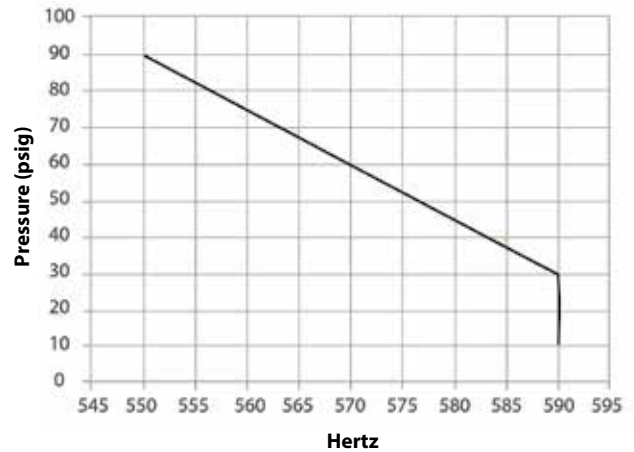

SCPVD BI-POLAR STEPPER MOTOR DRIVER

The SCPVD is a bi-polar stepper motor driver board which can be used for stepper motors up to a max 2A/phase. It is based on the Allegro A4988 motor driver. The driver requires a motor drive voltage of 7 to 35 volts. An external controller is required to deliver step and direction signals to the driver board. The SCPVD is capable of micro-stepping and defaults to a 16th step micro-stepping mode. The step mode as well as several other options such as sleep, enable, and reset can be toggled on and off.



- Medical, analytical, and industrial gas mixing
- Anesthesia equipment
- Precision flow control
- Cuff/bladder pressure control
- Process flow control
- Variable speed control
- Automation of needle valve

For more details, visit clippard.com/scpv



Part No.	Description
SCPVD-1	SCPVD-1 SCPV Valve Driver

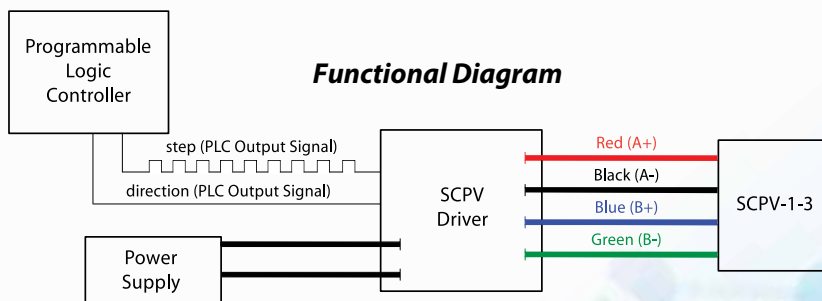

PROPORTIONAL ISOLATION

NEEDLE VALVE

COMING SOON!

Clippard's next-generation proportional valve is specially designed for maximum controllability of fluid in medical and analytical applications. This unique valve is able to be customized to meet the specific flow, pressure, life, and control requirements your applications demand.

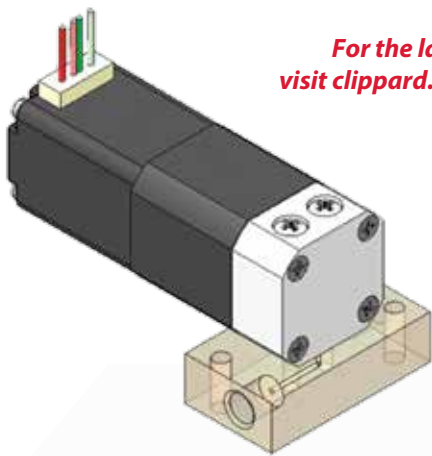

**For the latest details,
visit clippard.com/link/pro-iso**

**Specifications not final.*

Custom Application Example
Flow Rate vs. Distance*

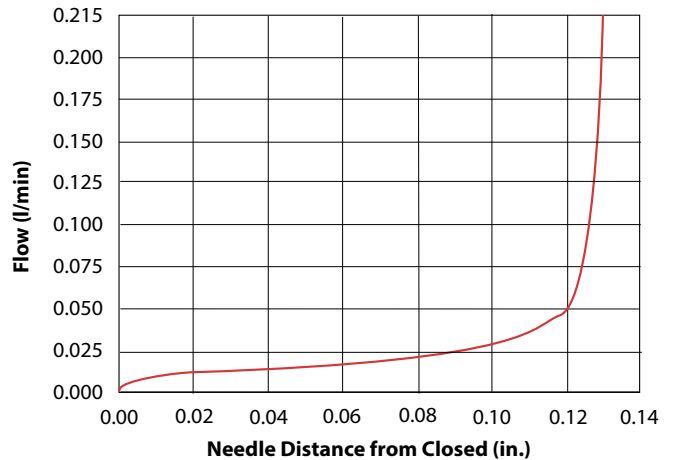

- Specially designed for analytical and biomedical applications
- Able to handle a wide variety of flow ranges
- Precision control at low flow ranges
- Diaphragm isolation capability
- Low internal and dead volume
- Compact, low profile design
- Quiet operation



For all the latest product news and updates, visit us online at

clippard.com

Product Specifications • 2D & 3D Files • Online Ordering

WHAT IS HYSTERESIS?

What is hysteresis? Is it important for your application? What effects could it have? Generally speaking, hysteresis is a lag in reaction to a force. It can be found everywhere—from physics and engineering to biology, chemistry, and even economics. In this article, we explain the fundamentals and complexities as we explore how hysteresis affects the proportional control of fluids.

THE BASICS

To understand hysteresis in some of its more complex states, it helps to first look at it in some of its simplest forms. Frictional hysteresis is relatively easy to understand because we can see—and sometimes feel—the results. Mechanical hysteresis is often referred to as “play” or “slop.” Think about a single knob water fixture that you turn clockwise to turn the water on. With this knob, you know that if you turn it directly to the 12 o’clock position without going too far, you get perfect water flow. However, this is an older faucet with a little “play” in the handle. If you go past 12 o’clock, you end up needing to turn back to 11 o’clock to get that same perfect water flow. As you turn the faucet back, the “play” you are experiencing is a lag. This is an example of hysteresis.

PROPORTIONAL VALVES & HYSTERESIS

Hysteresis is the maximum difference in current required to achieve a set flow, relative to the maximum current. This can be expressed mathematically as:

$$H = \left(\frac{I_{UP} - I_D}{I_{MAX}} \right) \times 100\%$$

H = Hysteresis, I = Current (I_{UP} = flowing up, I_D = flowing down)

As it relates to proportional valves, hysteresis is the difference you see in flow when you go directly to a particular point, compared to when you go past that flow point and try to return back to it.

For example, consider a standard current driven proportional valve with a nominal hysteresis of 10%. If we apply 0.15 amps to achieve 1.0 l/min, then turn the current up to 0.2 amps for more flow, a nominal hysteresis of 10% means that when we come back down to 1.0 l/min, we would need to be about 10% lower with our supplied current to reach the original flow rate.

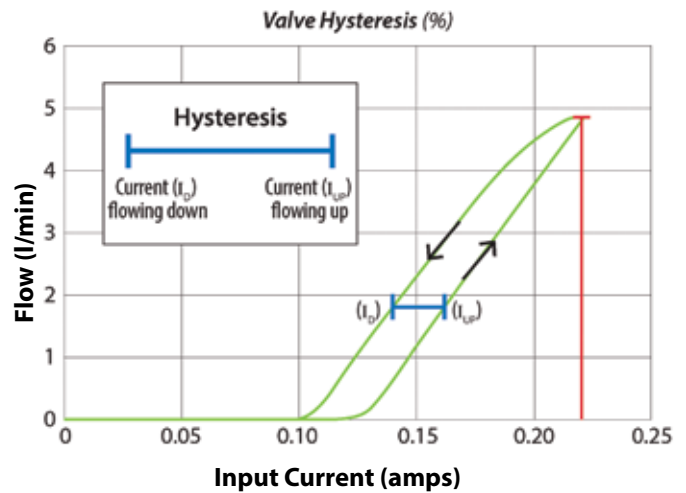

The hysteresis we see in current driven proportional valves is primarily magnetic. When we supply current to the valve’s coil, we are producing an electromagnetic field which forces the poppet to move. It takes a greater force to open the valve than it does to close the valve—it requires more current to open on the uphill side of the flow curve than it requires on the downhill side of the flow curve.

MINIMIZING HYSTERESIS IN APPLICATIONS

Getting to the lowest hysteresis possible is a challenge. When working with solenoid driven valves, many variables such as temperature, wear, and spring rates can affect the magnetic hysteresis. Ultimately, good control can be achieved as long as the valve performance is repeatable. Any valve with consistent performance can greatly reduce hunting—when the system overshoots and undershoots multiple times to get to a point—in closed loop systems.

The lowest hysteresis proportional valve Clippard offers is the SCPV series stepper-controlled proportional valve. This valve is driven by a miniature stepper motor which has zero magnetic hysteresis and a mere 2% (nominal) mechanical hysteresis. This is the result of small amounts of “play” in the actuator. Think of a basic needle valve that you would adjust with your fingers, then put a stepper motor on top. Clippard’s SCPV stepper-controlled proportional valves have become very popular in systems without feedback, because they can be commanded to a predetermined step to achieve repeatable performance.



Understanding the best seal material for your application is imperative. Common factors that may need to be evaluated include chemical compatibility, extreme temperatures, cleaning requirements, or sometimes even restrictions on material outgassing. Clippard offers a variety of materials to meet the needs of many different types of demanding applications.

CHEMICAL COMPATIBILITY

The most common reason to change materials in a valve is chemical compatibility. For example, a valve controlling the flow of acetone will have a short life if equipped with standard nitrile seals. In this case, selecting a different seal material that is more compatible with acetone will greatly extend the life of the valve. By referring to the Chemical Compatibility Chart (far right, top) we can see that for use with acetone, EPDM is the recommended material.

TEMPERATURE

Some applications expose valves to extreme temperatures. In these situations, it is important that the seal materials can withstand the environments they will be exposed to. For example, a valve that needs to be autoclaved for cleaning may be exposed to temperatures as high as 300°F. This extreme heat can damage standard nitrile seals, but this is easily avoided by selecting a material compatible with higher temperatures. By referring to the Material Properties

Chart (far right, bottom) we can see that there are a variety of other seal materials to choose from which can handle temperatures reaching 300°F.

SPECIAL MEDIA

Depending on the application, the media being passed through the valve may sometimes necessitate other special requirements. For example, applications involving corrosive fluids place greater demand on all wetted areas of the valve. In this case, a media isolation valve often provides the ideal solution. Clippard's line of PTFE media isolation valves (p. 68) are designed such that PTFE is the only wetted material, making them well-suited for these types of applications.

In other situations, applications may involve media with large particulates, or media that is especially sensitive to contamination. In these cases, a pinch valve often provides the ideal solution. Clippard offers both pneumatic (p. 70) and electronic (p. 71) pinch valves with a variety of different types of tubing including medical/laboratory grade silicone, FDA-approved food grade silicone, and polyurethane. The tubing is disposable and easy to replace, providing cleanliness, convenience, and a completely unobstructed flow path.

For help selecting materials for your application, contact your local Clippard distributor or call **877-245-6247**.

CHEMICAL COMPATIBILITY CHART

Chemical Tests	Materials					
	Nitrile	EPDM	Neoprene	Urethane	Silicone	FKM
Density (gm/cm ³)	0.98	0.86	1.24	1.20	1.65	1.67
Flame Resistance <i>Melts at 850°F</i>	POOR <i>Burns</i>	POOR <i>Burns</i>	GOOD <i>Sparks</i>	GOOD	GOOD	FAIR
Acetone	D 125% / 3 days*	[A]	D 31% / 3 days*	D 87% / 3 days*	B 18% / 7 days*	D 200% / 7 days*
Brake Fluid	C	[A]	B	D	A	D <i>Dissolves</i>
Gasoline	[A] 9% / 7 days*	D	D 55% / 7 days*	B	D 260% / 7 days*	[A] 3% / 7 days*
MEK	D	[A]	D	D	D	D 240% / 7 days*
Mineral Spirits	[A]	D	C <i>Not recommended</i>	B	D 110% / 7 days*	A
Oil-SAE	A	D	B / C	A	B	A
Perchloroethylene	B <i>Not recommended</i>	D	D	D 60% / 7 days*	B <i>Not recommended</i>	[A]
Turpentine	[A] 9% / 3 days*	D 163% / 3 days*	D 60% / 3 days*	D 21% / 3 days*	D 98% / 3 days*	[A] 0% / 3 days*

"Burns" means that the material will continue to burn even after the flame source is removed

*Percent volumetric swelling / number of days (actual results); Volumetric swelling in 30 days: A < 15%, B < 30%, C < 50%

[A] - Recommended; D - Not Recommended

MATERIAL PROPERTIES CHART

Properties	Materials					
	Nitrile	EPDM	Neoprene	Urethane	Silicone	FKM
Temperature (°F)	-40 to 250	-60 to 300	-45 to 250	60 to 225	-75 to 450	-20 to 400
Shelf Life	15 years	Unlimited	15 years	5 years	Unlimited	Unlimited
Mold Shrinkage	1.5 to 3.5%	1.9 to 3.5%	1.0 to 3.0%	1.6 to 3.3%	2.0 to 5.0%	2.0 to 4.5%
Cost	Excellent	Excellent	Good	Poor	Fair	Fair
Abrasion Resistance	Good / Excellent	Good	Good / Excellent	Excellent	Poor	Good
Compress Set	Good	Fair / Good	Fair / Good	Good / Excellent	Good / Excellent	Good
Tear Resistance	Good	Fair / Good	Good	Excellent	Poor	Fair / Good

Isolation Valves



NIV SERIES PTFE MEDIA ISOLATION VALVES

- *Ideal for use with corrosive media*
- *Low power consumption and fast response time*
- *Compact, lightweight design*
- *Minimal dead volume*
- *All wetted areas PTFE*

p. 68



NIV SERIES PTFE MEDIA ISOLATION MIXING VALVES

- *2-Way Normally-Closed*
- *Ideal for gradient, mixing, and diverting applications*
- *Compatible with corrosive fluids*
- *Variety of multi-valve configurations*

p. 69



NPV SERIES ELECTRONIC PINCH VALVES

- *Small, compact design*
- *Hygienic and easy to clean (replace tubes)*
- *Low power consumption*
- *High cycle life*
- *Able to handle whole blood and particulate matter*

p. 70



NPP SERIES PNEUMATIC PINCH VALVES

- *Small, compact design*
- *Hygienic and easy to clean (replace tubes)*
- *Low power consumption*
- *High cycle life*
- *Able to handle whole blood and particulate matter*

p. 71

PROBLEM

Many applications require the use of media that is not well suited for standard product materials. This application utilized a special media that was not only corrosive, but also exceptionally expensive. The customer sought a valve which could tolerate the media, but an emphasis was placed on minimizing volume as well in order to reduce the overall cost incurred with running the system.

SOLUTION

One of the primary benefits of Clippard's NIV series media isolation valves is that all wetted areas of the valve are constructed of PTFE, making the valve ideal for use with corrosive media. The valve also features minimal dead volume, which was especially important to this customer who was interested in conserving as much media as possible.

Considering the customer's underlying goal, Clippard proposed an alternative solution which involved the design of a special integrated manifold. The unique new design reduced potential leak points by eliminating the need for extra fittings and reduced the overall volume of media. Off the shelf, Clippard's isolation valve met the needs of this application. However, the extra effort proved more than worthwhile.

WHAT CAN CLIPPARD DO FOR YOU?

877-245-6247



NIV SERIES MEDIA ISOLATION VALVES

2-WAY & 3-WAY N.O. & N.C. PTFE VALVES



The Clippard NIV series media isolation valve is a solenoid-operated device that uses a flexible diaphragm to isolate the actuation mechanism from the fluid path. Media isolation valves are commonly used for a wide variety of applications, including those that require precise, repeatable dispensing of media for analytical instrumentation. All wetted areas of the valve are PTFE, making this series ideal for use with corrosive media.

A unique feature of the NIV series is the one-piece valve stem that functions as a sealing membrane while also supporting and centralizing the poppet in the seating area. This multi-functional poppet/diaphragm/stem results in a simplified design with fewer parts, longer life, and minimal dead volume. Choose from four orifice sizes available as 2-Way Normally-Closed, 2-Way Normally-Open, or 3-Way Selector/Diverter. Special configurations available by request.

Valve Type	2-Way Normally-Closed, 2-Way Normally-Open, 3-Way Selector/Diverter
Medium	Air, water, gas, or compatible fluids
Max. Coil Temp. Rating	158°F
Operating Pressure	Vacuum to 30 psig
Flow	10 to 60 l/min
Max. Pressure Range	28" Hg to 30 psig
Power Consumption	1.0 to 7.2 watts
Response Time	5 to 20 ms
Electrical Connections	18" wire leads
Voltage	12 or 24 VDC
Ports	#10-32, 1/4-28 or 1/8 NPS
Mounting	#2-56, #4-40, or manifold mount
Wetted Materials	PTFE
More Details	clippard.com/link/niv

- Low power consumption
- Compact, lightweight design
- Bidirectional
- Minimal dead volume
- All wetted areas PTFE
- Ideal for use with corrosive media
- High cycle life
- Fast response time

Valve Type	Orifice Size	Ports	STANDARD STYLE		INTEGRATED MANIFOLD	
			12 VDC	24 VDC	12 VDC	24 VDC
2-Way Normally-Closed	0.040"	#10-32	NR1-2-12	NR1-2-24	NR1-2M-12	NR1-2M-24
	0.062"	1/4-28 UNF	NR2-2-12	NR2-2-24	NR2-2M-12	NR2-2M-24
	0.093"	1/4-28 UNF	NR3-2-12	NR3-2-24	NR3-2M-12	NR3-2M-24
	0.156"	1/8 NPS	NR4-2-12	NR4-2-24	NR4-2M-12	NR4-2M-24
2-Way Normally-Open	0.040"	#10-32	NR10-2-12	NR10-2-24	NR10-2M-12	NR10-2M-24
	0.062"	1/4-28 UNF	NR20-2-12	NR20-2-24	NR20-2M-12	NR20-2M-24
	0.093"	1/4-28 UNF	NR30-2-12	NR30-2-24	NR30-2M-12	NR30-2M-24
	0.156"	1/8 NPS	NR40-2-12	NR40-2-24	NR40-2M-12	NR40-2M-24
3-Way Selector/Diverter	0.040"	#10-32	NR1-3-12	NR1-3-24	NR1-3M-12	NR1-3M-24
	0.062"	1/4-28 UNF	NR2-3-12	NR2-3-24	NR2-3M-12	NR2-3M-24
	0.093"	1/4-28 UNF	NR3-3-12	NR3-3-24	NR3-3M-12	NR3-3M-24
	0.156"	1/8 NPS	NR4-3-12	NR4-3-24	NR4-3M-12	NR4-3M-24

NIV SERIES GRADIENT MIXING VALVES

2-WAY N.C. PTFE MIXING VALVES

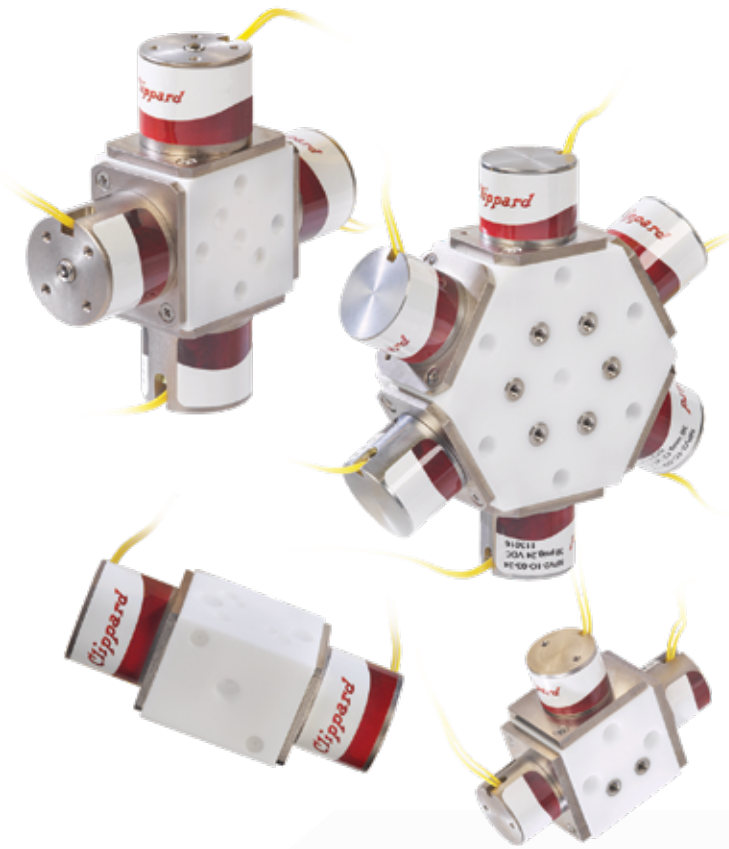

NIV series mixing valves feature multiple solenoids connected around a central body. This unique design provides significant reduction in internal volume with enhanced mixing capabilities. Each actuator operates independently, allowing for flow of various media to be mixed or for one media to be split into multiple streams.

These valves utilize a standard 2-Way, Normally-Closed configuration. Standard options include four different orifice sizes, available in 12 or 24 VDC.

- Ideal for gradient, mixing, and diverting applications
- Compatible with corrosive fluids
- Variety of multi-valve configurations

Valves	Orifice Size	Ports	12 VDC	24 VDC
2	0.040"	#10-32	NR1-2-12-G2	NR1-2-24-G2
	0.062"	1/4-28 UNF	NR2-2-12-G2	NR2-2-24-G2
	0.093"	1/4-28 UNF	NR3-2-12-G2	NR3-2-24-G2
	0.156"	1/8 NPS	NR4-2-12-G2	NR4-2-24-G2
3	0.040"	#10-32	NR1-2-12-G3	NR1-2-24-G3
	0.062"	1/4-28 UNF	NR2-2-12-G3	NR2-2-24-G3
	0.093"	1/4-28 UNF	NR3-2-12-G3	NR3-2-24-G3
	0.156"	1/8 NPS	NR4-2-12-G3	NR4-2-24-G3
4	0.040"	#10-32	NR1-2-12-G4	NR1-2-24-G4
	0.062"	1/4-28 UNF	NR2-2-12-G4	NR2-2-24-G4
	0.093"	1/4-28 UNF	NR3-2-12-G4	NR3-2-24-G4
	0.156"	1/8 NPS	NR4-2-12-G4	NR4-2-24-G4
6	0.040"	#10-32	NR1-2-12-G6	NR1-2-24-G6
	0.062"	1/4-28 UNF	NR2-2-12-G6	NR2-2-24-G6
	0.093"	1/4-28 UNF	NR3-2-12-G6	NR3-2-24-G6
	0.156"	1/8 NPS	NR4-2-12-G6	NR4-2-24-G6

Valve Type	2-Way Normally-Closed, 2-Way Normally-Open, 3-Way Selector/Diverter
Medium	Air, water, gas, or compatible fluids
Max. Coil Temp. Rating	158°F
Operating Pressure	Vacuum to 30 psig
Flow	10 to 60 l/min
Max. Pressure Range	28" Hg to 30 psig
Power Consumption	1.0 to 7.2 watts
Response Time	5 to 20 ms
Electrical Connections	18" wire leads
Voltage	12 or 24 VDC
Ports	#10-32, 1/4-28 or 1/8 NPS
Mounting	#2-56, #4-40, or manifold mount
Wetted Materials	PTFE
More Details	clippard.com/link/niv

Available with two, three, four, and six valves, these units provide a compact solution for applications requiring an inert wetted path for corrosive or aggressive liquids. Special configurations available by request.

ELECTRONIC NPV SERIES PINCH VALVES

2-WAY & 3-WAY VALVES WITH DISPOSABLE TUBING



- Small, compact design
- Hygienic and easy to clean (replace tubes)
- Low power consumption
- High cycle life
- Can handle whole blood and particulate matter
- Unobstructed flow path
- Each valve comes with 12" of silicone tubing, pre-installed
- Choose from a large variety of easily replaceable tubing

All NPV Series pinch valves ship with 12" of high quality silicone tubing pre-installed. Standard options include medical/laboratory grade or FDA approved food grade silicone tubing. Custom valve configurations and additional tubing options are available (consult factory).

Valve Type	2-Way Normally-Open or Normally-Closed 3-Way (one tube N.O., one tube N.C.)
Medium	Air, water, gas, or compatible fluids
Max. Pressure Range	20 to 30 psig*
Power Consumption	1.0 to 7.2 watts
Electrical Connections	18" wire leads
Voltage	12 or 24 VDC
Mounting	#2-56, #4-40
Wetted Materials	Silicone tubing
More Details	clippard.com/link/npv

*With standard medical/laboratory grade silicone tubing

The Clippard NPV series pinch valve is a solenoid-operated device that is designed to open and close tubes for controlling flow of liquids and gases. Other valve types have internal passages that may cause small amounts of fluid to remain in the valve. Pinch valves have no areas or dead volume where fluid can become trapped. Only the inside of the tubing contacts the fluid. Energizing the solenoid retracts or extends the plunger, which opens or closes the tube. De-energizing the solenoid will allow the plunger to return to its original state.

NPV Series pinch valves are available with one tube or two tubes. The single tube versions function as standard "on/off" 2-Way valves and are available in Normally-Open or Normally-Closed. The two tube versions feature one Normally-Open tube and one Normally-Closed tube, allowing them to function as 3-Way valves.

Tubing Type	Max. Pressure	Power	Model	1 Tube N.C.	1 Tube N.O.	2 Tubes	I.D.	O.D.	Wall
Medical/ Laboratory Grade Silicone Tubing	30 psi	1 W	NPV1	NPV1-1C-01-□	NPV1-1O-01-□	NPV1-2D-01-□	0.030"	0.065"	0.0175"
		1.5 W	NPV2	NPV2-1C-02-□	NPV2-1O-02-□	NPV2-2D-02-□	1/32"	3/32"	0.0313"
				NPV2-1C-03-□	NPV2-1O-03-□	NPV2-2D-03-□	1/16"	1/8"	0.0313"
	20 psi	4.2 W	NPV3	NPV3-1C-04-□	NPV3-1O-04-□	NPV3-2D-04-□	1/16"	3/16"	0.0625"
				NPV3-1C-05-□	NPV3-1O-05-□	NPV3-2D-05-□	1/8"	1/4"	0.0625"
		7.2 W	NPV4	NPV4-1C-06-□	NPV4-1O-06-□	NPV4-2D-06-□	3/16"	5/16"	0.0625"
NPV4-1C-07-□	NPV4-1O-07-□			—	1/4"	3/8"	0.0625"		
Sanitary Food Grade Silicone Tubing	14 psi	1.5 W	NPV2	NPV2-1C-23-□	NPV2-1O-23-□	NPV2-2D-23-□	1/16"	1/8"	0.0313"
		4.2 W	NPV3	NPV3-1C-25-□	NPV3-1O-25-□	NPV3-2D-25-□	1/8"	1/4"	0.0625"
	9 psi	7.2 W	NPV4	NPV4-1C-27-□	NPV4-1O-27-□	—	1/4"	3/8"	0.0625"

PNEUMATIC NPP SERIES PINCH VALVES

2-WAY MINIATURE VALVES WITH DISPOSABLE TUBING



Clippard's NPP series miniature pneumatic pinch valves are air-piloted devices designed to open or close tubes for controlling flow of liquids and gases. Other valve types have internal passages that may cause small amounts of fluid to remain in the valve. Pinch valves have no areas of dead volume where fluid can become trapped. Only the inside of the tubing has contact with the fluid. The NPP series functions as a standard "on/off" 2-Way valve and is available in Normally-Open or Normally-Closed versions.

Pinch valves are especially well-suited for applications which benefit from a disposable flow path. Common industries that utilize pinch valves for isolating fluid from a mechanical valve include: drug dispensing, laboratory equipment, wastewater, medical devices, chemical, food and beverage equipment, ceramic/glass/plastic, and solids handling.

Valve Type	2-Way, Normally-Open & Normally-Closed
Medium	Air, water, gas, or compatible fluids
Max. Pilot Pressure	250 psig
Tubing Pressure	See chart below
Mounting	#4-40
Temperature Range	32 to 230°F
Wetted Materials	Medical or food grade silicone, or polyurethane
More Details	clippard.com/link/npp

- Small, compact design
- Hygienic and easy to clean (replace tubes)
- Low power consumption
- High cycle life
- Can handle whole blood and particulate matter
- Unobstructed flow path
- Each valve comes with 12" of silicone tubing, pre-installed
- Choose from a large variety of easily replaceable tubing

All NPP Series pinch valves ship with 12" of high quality tubing pre-installed. Standard options include medical/laboratory grade or FDA approved food grade silicone tubing, or polyurethane tubing. Custom valve configurations and additional tubing options are available (consult factory).

Tubing Type	Tubing Max. Pressure	1 Tube N.C.	Min. to Open*	1 Tube N.O.	Min. to Close*	I.D.	O.D.	Wall
Medical/ Laboratory Grade Silicone Tubing	30 psi	NPP2-1C-03	30 psig	NPP2-1O-01	15 psig	1/16"	1/8"	0.0313"
		NPP2-1C-04		NPP2-1O-02	40 psig	1/16"	3/16"	0.0625"
	20 psi	NPP4-1C-05	20 psig	NPP3-1O-05	10 psig	1/8"	1/4"	0.0625"
		NPP4-1C-06		NPP4-1O-06		3/16"	5/16"	0.0625"
		NPP4-1C-07		NPP4-1O-07		1/4"	3/8"	0.0625"
Polyurethane Tubing	105 psi	NPP2-1C-13	65 psig	NPP2-1O-13	50 psig	1/16"	1/8"	0.0313"
		NPP2-1C-15		NPP4-1O-15	45 psig	1/32"	3/32"	0.0313"
Sanitary Food Grade Silicone Tubing	14 psi	NPV2-1C-23	30 psig	NPP2-1O-23	15 psig	1/16"	1/8"	0.0313"
		NPV3-1C-25		NPP4-1O-25		1/8"	1/4"	0.0625"
	9 psi	NPV4-1C-27	20 psig	NPP4-1O-27	10 psig	1/4"	3/8"	0.0625"

*With max. pressure in tubing.

Directional Control Valves

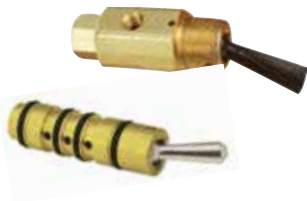

TOGGLE VALVES

- *Momentary or detented*
- *Metal or plastic toggles*
- *Variety of seal and lubricant options*

pp. 78-84



STEM VALVES

- *Flow path changes when stem is depressed or released*
- *Can be used with a variety of different actuators*

pp. 85-88



SLEEVE VALVES

- *Smooth, low friction operation*
- *Variety of inlet and outlet porting reduces need for fittings*

p. 89



LIMIT VALVES

- Heavy duty lever-actuated series with multiple lever arm styles
- Miniature 3-Way

p. 89



ACTUATORS

- Ball, roller, and double-pivoted cam actuators
- Single-acting, spring return pilot and vacuum actuators
- Push button actuators

pp. 89-92



MANUAL VALVES

- Manually actuated by hand or foot
- Push/pull and lever styles
- Palm button valves
- Foot pedal valves

p. 93

Many items also available with metric ports.
For more information, visit clippard.com/link/metric

SELECTION GUIDE

2-Way Toggle Valves

Part No.	Style	Flow @ 100 psig	Comparison of Flow	Inlet	Outlet	Exhaust	N.O.	N.C.	Toggle	Page
									Action	
GTV-2	Poppet	1,900 l/min	██████████	1/4" NPT	1/4" NPT	-		•	Detented	88
GTV-2Q	Poppet	1,900 l/min	██████████	1/4" NPT	1/4" NPT	-		•	Detented	88
GTV-2-P12	Poppet	1,900 l/min	██████████	3/8" PQ	3/8" PQ	-		•	Detented	88
GTV-2Q-P12	Poppet	1,900 l/min	██████████	1/4" NPT	3/8" PQ	-		•	Detented	88
MTV-2	Poppet	190 l/min	██	#10-32	#10-32	-		•	Detented	81
MTV-2P	Poppet	190 l/min	██	1/8" NPT	#10-32	-		•	Detented	81
TV-2S	Spool	225 l/min	██	#10-32	#10-32	-		•	Detented	79
TV-2SF	Spool	225 l/min	██	#10-32	#10-32	-		•	Detented	79
TV-2SP	Spool	225 l/min	██	1/8" NPT	#10-32	-		•	Detented	79
TV-2SFP	Spool	225 l/min	██	1/8" NPT	#10-32	-		•	Detented	79
TV-2M	Poppet	190 l/min	██	#10-32	#10-32	-		•	Momentary	79
TV-2MF	Poppet	190 l/min	██	#10-32	#10-32	-		•	Momentary	79
TV-2MP	Poppet	190 l/min	██	1/8" NPT	#10-32	-		•	Momentary	79
TV-2MFP	Poppet	190 l/min	██	1/8" NPT	#10-32	-		•	Momentary	79
TVO-2M	Spool	225 l/min	██	#10-32	#10-32	-	•		Momentary	79
TVO-2MF	Spool	225 l/min	██	#10-32	#10-32	-	•		Momentary	79
TVO-2MP	Spool	225 l/min	██	1/8" NPT	#10-32	-	•		Momentary	79
TVO-2MFP	Spool	225 l/min	██	1/8" NPT	#10-32	-	•		Momentary	79

2-Way Stem Valves

Part No.	Style	Flow @ 100 psig	Comparison of Flow	Inlet	Outlet	Exhaust	N.O.	N.C.	Page
GV-2	Poppet	1,900 l/min	██████████	1/4" NPT	1/4" NPT	-		•	88
GV-2Q	Poppet	1,900 l/min	██████████	1/4" NPT	1/4" NPT	-		•	88
GV-2Q-P12	Poppet	1,900 l/min	██████████	1/4" NPT	3/8" PQ	-		•	88
GV-2-P12	Poppet	1,900 l/min	██████████	3/8" PQ	3/8" PQ	-		•	88
GV-2C	Poppet	1,900 l/min	██████████	Cartridge	Cartridge	-		•	88
MAV-2	Poppet	190 l/min	██	#10-32	#10-32	-		•	85
MAV-2P	Poppet	190 l/min	██	1/8" NPT	#10-32	-		•	85
MAV-2C	Poppet	170 l/min	██	Cartridge	Cartridge	-		•	85
MAVO-2	Spool	280 l/min	██	#10-32	#10-32	-	•		85
MAVO-2P	Spool	280 l/min	██	1/8" NPT	#10-32	-	•		85
MAVO-2C	Spool	280 l/min	██	Cartridge	Cartridge	-	•		85
MJV-2	Poppet	710 l/min	██████	1/8" NPT	1/8" NPT	-		•	87
MJV-2C	Poppet	620 l/min	██████	Cartridge	Cartridge	-		•	87
MJVO-2	Spool	340 l/min	██	1/8" NPT	1/8" NPT	-	•		87
MJVO-2C	Spool	400 l/min	██	Cartridge	Cartridge	-	•		87

SELECTION GUIDE

3-Way Toggle Valves

Part No.	Style	Flow @ 100 psig	Comparison of Flow	Inlet	Outlet	Exhaust	N.O.	N.C.	Toggle	Page
									Action	
FTV-3	Spool	280 l/min	■	#10-32	#10-32	#10-32		•	Detented	82
FTV-3F	Spool	280 l/min	■	#10-32	#10-32	#10-32		•	Detented	82
FTV-3P	Spool	295 l/min	■	1/8" NPT	1/8" NPT	1/8" NPT		•	Detented	82
FTV-3FP	Spool	295 l/min	■	1/8" NPT	1/8" NPT	1/8" NPT		•	Detented	82
GTV-3	Poppet	1,900 l/min	■■■■	1/4" NPT	1/4" NPT	hole in body		•	Detented	88
GTV-3Q	Poppet	1,900 l/min	■■■■	1/4" NPT	1/4" NPT	hole in body		•	Detented	88
GTV-3-P12	Poppet	1,900 l/min	■■■■	3/8" PQ	3/8" PQ	hole in body		•	Detented	88
GTV-3Q-P12	Poppet	1,900 l/min	■■■■	1/4" NPT	3/8" PQ	hole in body		•	Detented	88
MTV-3	Poppet	190 l/min	■	#10-32	#10-32	#10-32		•	Detented	81
MTV-3P	Poppet	190 l/min	■	1/8" NPT	#10-32	#10-32		•	Detented	81
MJTV-3	Poppet	710 l/min	■■■	1/8" NPT	1/8" NPT	1/8" NPT		•	Detented	83
TV-3S	Spool	225 l/min	■	#10-32	#10-32	hole in body		•	Detented	79
TV-3SF	Spool	225 l/min	■	#10-32	#10-32	hole in body		•	Detented	79
TV-3SP	Spool	225 l/min	■	1/8" NPT	#10-32	hole in body		•	Detented	79
TV-3SFP	Spool	225 l/min	■	1/8" NPT	#10-32	hole in body		•	Detented	79
TV-3M	Poppet	190 l/min	■	#10-32	#10-32	hole in body		•	Momentary	79
TV-3MF	Poppet	190 l/min	■	#10-32	#10-32	hole in body		•	Momentary	79
TV-3MP	Poppet	190 l/min	■	1/8" NPT	#10-32	hole in body		•	Momentary	79
TV-3MFP	Poppet	190 l/min	■	1/8" NPT	#10-32	hole in body		•	Momentary	79
TVO-3M	Spool	225 l/min	■	#10-32	#10-32	hole in body	•		Momentary	79
TVO-3MF	Spool	225 l/min	■	#10-32	#10-32	hole in body	•		Momentary	79
TVO-3MP	Spool	225 l/min	■	1/8" NPT	#10-32	hole in body	•		Momentary	79
TVO-3MFP	Spool	225 l/min	■	1/8" NPT	#10-32	hole in body	•		Momentary	79
SMTV-3	Spool	51 l/min	■	#3-56*	#3-56*	hole in body	•	•	Detented	78

*With hose barbs uninstalled

Temperature Range

All directional control valves in this section have a temperature range of 32 to 230°F.



SELECTION GUIDE

3-Way Stem Valves

Part No.	Style	Flow @ 100 psig	Comparison of Flow	Inlet	Outlet	Exhaust	N.O.	N.C.	Page
FV-3	Spool	280 l/min	■	#10-32	#10-32	#10-32	•	•	86
FV-3D	Spool	280 l/min	■	#10-32	#10-32	#10-32	•	•	86
FV-3DP	Spool	295 l/min	■	1/8" NPT	1/8" NPT	1/8" NPT	•	•	86
FV-3P	Spool	295 l/min	■	1/8" NPT	1/8" NPT	1/8" NPT	•	•	86
GV-3	Poppet	1,900 l/min	■■■■	1/4" NPT	1/4" NPT	hole in stem		•	88
GV-3Q	Poppet	1,900 l/min	■■■■	1/4" NPT	1/4" NPT	hole in stem		•	88
GV-3-P12	Poppet	1,900 l/min	■■■■	3/8" PQ	3/8" PQ	hole in stem		•	88
GV-3Q-P12	Poppet	1,900 l/min	■■■■	1/4" NPT	3/8" PQ	hole in stem		•	88
GV-3C	Poppet	1,900 l/min	■■■■	Cartridge	Cartridge	hole in stem		•	88
MAV-3	Poppet	190 l/min	■	#10-32	#10-32	through stem		•	85
MAV-3P	Poppet	190 l/min	■	1/8" NPT	#10-32	through stem		•	85
MAV-3C	Poppet	170 l/min	■	Cartridge	Cartridge	through stem		•	85
MAVO-3	Spool	280 l/min	■	#10-32	#10-32	holes in body	•		85
MAVO-3P	Spool	280 l/min	■	1/8" NPT	#10-32	holes in body	•		85
MAVO-3C	Spool	280 l/min	■	Cartridge	Cartridge	holes in body	•		85
MJV-3	Poppet	710 l/min	■■■■	1/8" NPT	1/8" NPT	through stem		•	87
MJV-3C	Poppet	620 l/min	■■■■	Cartridge	Cartridge	through stem		•	87
MJVO-3	Spool	340 l/min	■	1/8" NPT	1/8" NPT	holes in body	•		87
MJVO-3C	Spool	400 l/min	■	Cartridge	Cartridge	holes in body	•		87
SMAV-3	Spool	51 l/min	■	#3-56	#3-56	#3-56	•	•	78

Temperature Range

All directional control valves in this section have a temperature range of 32 to 230°F.



SELECTION GUIDE

4-Way Toggle Valves

Part No.	Style	Flow @ 100 psig	Comparison of Flow	Inlet	Outlet	Exhaust	N.O.	N.C.	Toggle	Page
									Action	
MJTV-4	Spool	295 l/min	■	1/8" NPT	1/8" NPT	holes in body	•	•	Detented	83
MJTV-4F	Spool	295 l/min	■	1/8" NPT	1/8" NPT	holes in body	•	•	Detented	83
MJTV-5	Spool	295 l/min	■	1/8" NPT	1/8" NPT	1/8" NPT	•	•	Detented	83
MJTV-5F	Spool	295 l/min	■	1/8" NPT	1/8" NPT	1/8" NPT	•	•	Detented	83
MTV-4	Spool	280 l/min	■	#10-32	#10-32	holes in body	•	•	Detented	81
MTV-4F	Spool	280 l/min	■	#10-32	#10-32	holes in body	•	•	Detented	81
MTV-5	Spool	280 l/min	■	#10-32	#10-32	#10-32	•	•	Detented	81
MTV-5F	Spool	280 l/min	■	#10-32	#10-32	#10-32	•	•	Detented	81
86 TV-4D	Spool	210 l/min	■	#10-32	#10-32	holes in body		•	Detented	84
TV-4M	Spool	210 l/min	■	#10-32	#10-32	holes in body		•	Momentary	84
TV-4DM	Spool	210 l/min	■	#10-32	#10-32	holes in body		•	Det./Moment.	84
TV-4DP	Spool	210 l/min	■	1/8" NPT	1/8" NPT	holes in body		•	Detented	84
TV-4MP	Spool	210 l/min	■	1/8" NPT	1/8" NPT	holes in body		•	Momentary	84
TV-4DMP	Spool	210 l/min	■	1/8" NPT	1/8" NPT	holes in body		•	Det./Moment.	84
TV-4DH	Spool	210 l/min	■	#10-32	#10-32	holes in body		•	Detented	84
TV-4MH	Spool	210 l/min	■	#10-32	#10-32	holes in body		•	Momentary	84
TV-4DMH	Spool	210 l/min	■	#10-32	#10-32	holes in body		•	Detented	84
TV-4DPH	Spool	210 l/min	■	#10-32	#10-32	holes in body		•	Momentary	84
TV-4MPH	Spool	210 l/min	■	#10-32	#10-32	holes in body		•	Detented	84
TV-4DMPH	Spool	210 l/min	■	#10-32	#10-32	holes in body		•	Det./Moment.	84

4-Way Stem Valves

Part No.	Style	Flow @ 100 psig	Comparison of Flow	Inlet	Outlet	Exhaust	N.O.	N.C.		Page
FV-4	Spool	280 l/min	■	#10-32	#10-32	holes in body	•	•		86
FV-4P	Spool	295 l/min	■	1/8" NPT	1/8" NPT	holes in body	•	•		86
FV-4D	Spool	280 l/min	■	#10-32	#10-32	holes in body	•	•		86
FV-4DP	Spool	295 l/min	■	1/8" NPT	1/8" NPT	holes in body	•	•		86
FV-5	Spool	280 l/min	■	#10-32	#10-32	#10-32	•	•		86
FV-5P	Spool	295 l/min	■	1/8" NPT	1/8" NPT	1/8" NPT	•	•		86
FV-5D	Spool	280 l/min	■	#10-32	#10-32	#10-32	•	•		86
FV-5DP	Spool	295 l/min	■	1/8" NPT	1/8" NPT	1/8" NPT	•	•		86
MAV-4	Spool	240 l/min	■	#10-32	#10-32	holes in body	•	•		85
MAV-4D	Spool	240 l/min	■	#10-32	#10-32	holes in body	•	•		85
MJV-4	Spool	400 l/min	■	1/8" NPT	1/8" NPT	holes in body	•	•		87
MJV-4D	Spool	400 l/min	■	1/8" NPT	1/8" NPT	holes in body	•	•		87

3-WAY #3-56 SUB-MINIATURE SPOOL VALVES

SMTV/SMAV SERIES

3-Way toggle and push button valves have 1/16" tube barbs. The push-button valve can be used as a Normally-Open or Normally-Closed 3-Way.

Medium	Air
Stem Travel	1/16"
Input Pressure	100 psig max.
Ports	#3-56 with 1/16" I.D. hose barbs
Air Flow	51 l/min @ 100 psig
Force to Depress Push Stem	SMAV: 20 oz. SMTV: 24 oz. nominal
Spool Material	Stainless steel

Pressure vs. Flow

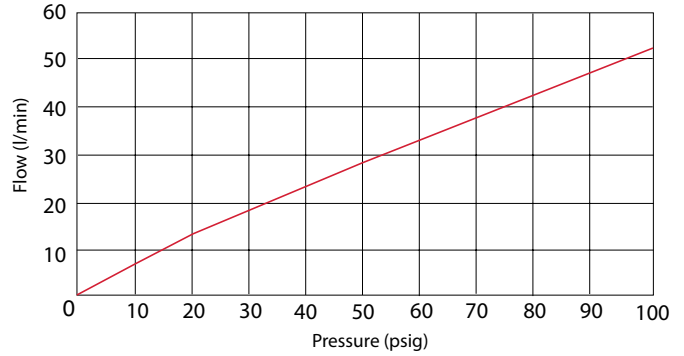

- Subminiature size spool design
- Multiple colored buttons for SMAV



Normally-Open/
Normally-Closed

Function	Part No.
N.O.-N.C.	SMAV-3

Four colors of snap-on push buttons included with each valve

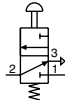

Normally-Closed

Function	Part No.
Normally-Closed	SMTV-3

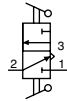

Their small, compact size make push buttons adaptable to panel mounting. Unlike set screw retained buttons, the screw-on design will not allow the button to fall off. Designed to work with Clippard MAV, MJV, and FV series valves, these buttons also help protect the valve by preventing over-traveling of the stem and the potential for side-load on the valve. See p. 91 for more information.

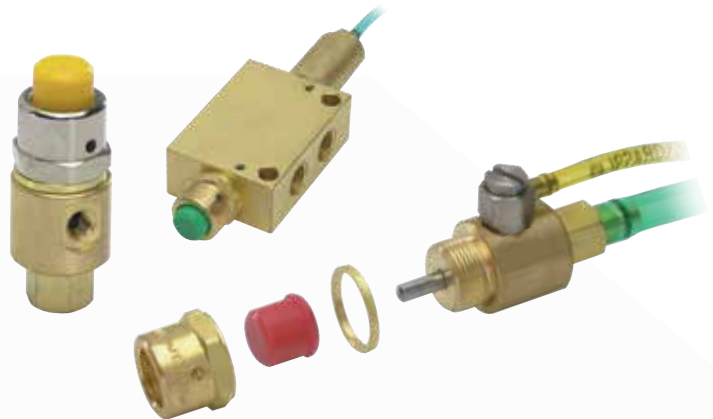

Custom Solutions

Need a product that fits your application perfectly? Clippard can design or modify standard products to suit your **exact** needs. We understand that catalog products are sometimes close, but still not quite what your application requires.

Call **877-245-6247** today so we can discuss your application and specific requirements.



2-WAY & 3-WAY #10-32 & 1/8" NPT TOGGLE VALVES

TV/TVO SERIES

The function of a 2-Way valve is to turn an air supply on and off. In the "on" position, medium flows from inlet to outlet, and in the "off" position, the flow is blocked. 3-Way styles have an exhaust port which vents the outlet to atmosphere.

Medium	Air, water, or oil
Input Pressure	150 psig max.
Force to Rotate Toggle	12 oz. nominal
Mounting	#15/32-32 thread; nuts and lockwashers furnished
Materials	Brass body, nitrile seals, stainless steel stem and spring

Pressure vs. Flow

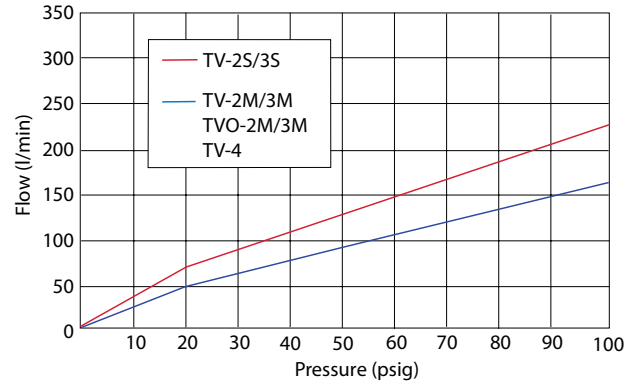

- Normally-Open or Normally-Closed
- NP steel or plastic toggles

N.C. POPPET VALVES WITH MOMENTARY ACTUATION



(TV-2MF shown; closed)

Port(s)	Toggle	2-Way	3-Way
#10-32	NP Steel	TV-2M	TV-3M
#10-32	Plastic	TV-2MF	TV-3MF
1/8" NPT	NP Steel	TV-2MP	TV-3MP
1/8" NPT	Plastic	TV-2MFP	TV-3MFP

Air Flow: 95 l/min @ 50 psig; 160 l/min @ 100 psig

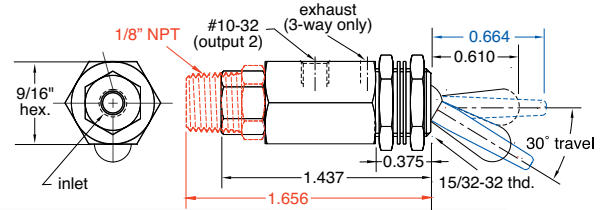

SPOOL VALVES WITH DETENTED ACTUATION



(TV-2SP shown; open)

Port(s)	Toggle	2-Way	3-Way
#10-32	NP Steel	TV-2S	TV-3S
#10-32	Plastic	TV-2SF	TV-3SF
1/8" NPT	NP Steel	TV-2SP	TV-3SP
1/8" NPT	Plastic	TV-2SFP	TV-3SFP

Air Flow, TV-3: 135 l/min @ 50 psig; 225 l/min @ 100 psig;

Air Flow, TV-2: 95 l/min @ 50 psig; 160 l/min @ 100 psig

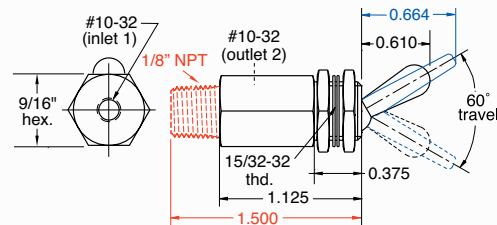

N.O. SPOOL VALVES WITH MOMENTARY ACTUATION



(TVO-3M shown; open)

Port(s)	Toggle	2-Way	3-Way
#10-32	NP Steel	TVO-2M	TVO-3M
#10-32	Plastic	TVO-2MF	TVO-3MF
1/8" NPT	NP Steel	TVO-2MP	TVO-3MP
1/8" NPT	Plastic	TVO-2MFP	TVO-3MFP

Air Flow: 95 l/min @ 50 psig; 160 l/min @ 100 psig

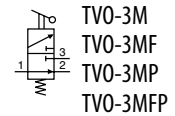
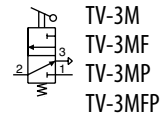
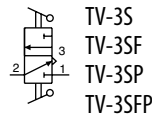
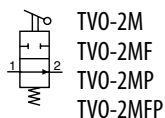
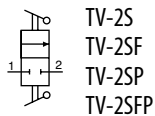
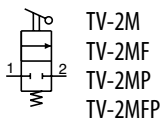
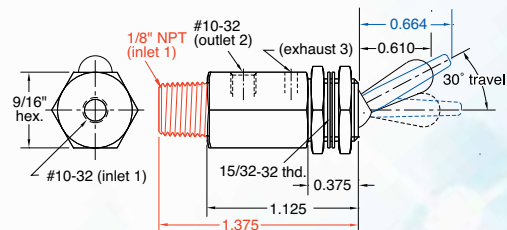

FILL & BLEED TOGGLE VALVES

FBV SERIES

The FBV-3 may be used to pressurize or “fill” a chamber or bladder by depressing the toggle in one direction and then de-pressurize or “bleed” that same chamber or bladder by depressing the toggle in the other direction. Toggling back and forth between the inlet and exhaust provides a fine adjustment of the required pressure in the chamber or bladder.

Medium	Air
Input Pressure	120 psig max.
Materials	Brass body, nitrile seals, stainless steel stem and spring
Force for Full Stem Travel	8 oz. nominal
Toggle	Plastic or ENP steel
Mounting	5/8-32 thread

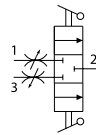
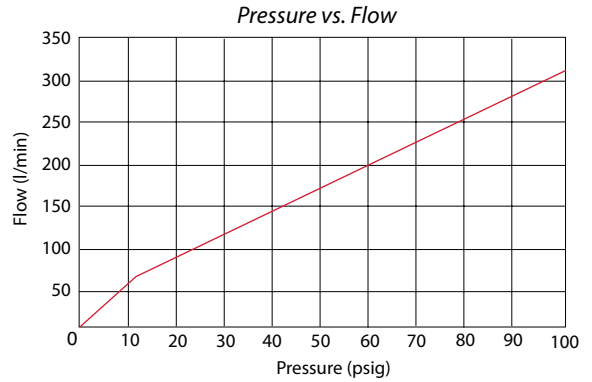

Air Flow
 125 l/min @ 50 psig
 210 l/min @ 100 psig

#10-32 Valves

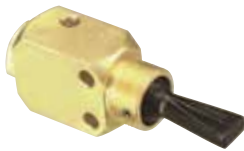

Plastic toggle shown

Flow	Function	Toggle	Part No.
Full	Detented/Detented	Plastic	FBV-3DF
Full	Momentary/Momentary	Plastic	FBV-3MF
Full	Detented/Momentary	Plastic	FBV-3DMF
Full	Detented/Detented	ENP Steel	FBV-3DFH
Full	Momentary/Momentary	ENP Steel	FBV-3MFH
Full	Detented/Momentary	ENP Steel	FBV-3DMFH

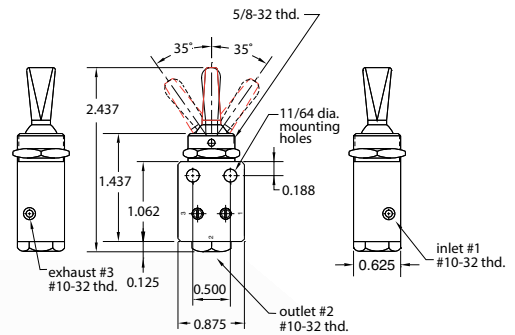

1/8" NPT Valves



ENP steel toggle shown

Flow	Function	Toggle	Part No.
Full	Detented/Detented	Plastic	FBV-3DPF
Full	Momentary/Momentary	Plastic	FBV-3MPF
Full	Detented/Momentary	Plastic	FBV-3DMPF
Full	Detented/Detented	ENP Steel	FBV-3DPFH
Full	Momentary/Momentary	ENP Steel	FBV-3MPFH
Full	Detented/Momentary	ENP Steel	FBV-3DMPFH

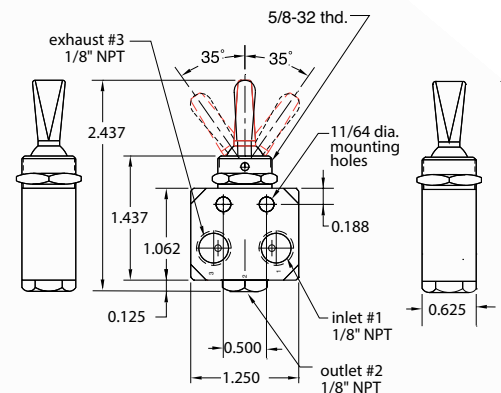

Model Number

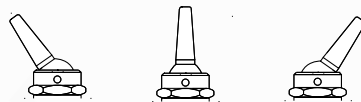

Model Number	Porting	Function	Toggle	Function
FBV-3DF	#10-32 1/8" NPT	Detented	Spring centered, all ports blocked	Detented
FBV-3MF	#10-32 1/8" NPT	Momentary		Momentary
FBV-3DMF	#10-32 1/8" NPT	Detented		Momentary

• Models may be used as pressure selectors

options (suffix)
 ENP Plating "-ENP" • FKM Seals "-V"

2-WAY, 3-WAY & 4-WAY #10-32 & 1/8" NPT TOGGLE VALVES

MTV SERIES

These #10-32 ported 2-Way, 3-Way, and 4-Way valves are manually actuated with a toggle. The toggles are electroless nickel plated steel and have a detent action. The MTV-5 has threaded exhaust and can be connected in a dual inlet pressure configuration.

Medium	Air, water, or oil
Input Pressure	150 psig max.
Air Flow	MTV-2: 113 l/min @ 50 psig; 205 l/min @ 100 psig MTV-3: 113 l/min @ 50 psig; 190 l/min @ 100 psig MTV-4, MTV-5: 170 l/min @ 50 psig; 280 l/min @ 100 psig
Force to Rotate Toggle	MTV-2, MTV-4: 12 oz. MTV-3, MTV-5: 16 oz. nominal
Mounting	15/32-32 thread; nut and lockwashers furnished
Materials	Brass body, nitrile seals, stainless steel stem and spring

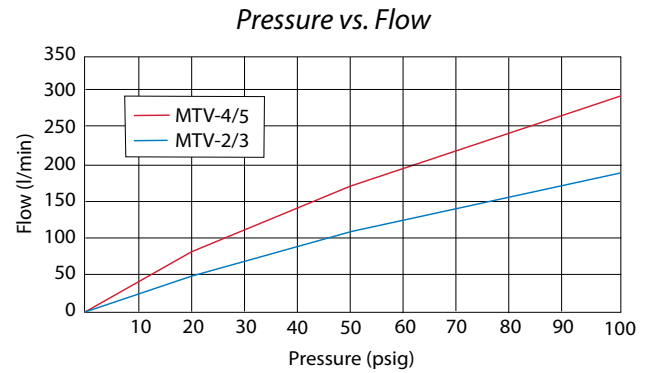

- MTV-2/3 are poppet valves
- MTV-4/5 are spool valves
- MTV-5 valves are fully-ported

options (suffix)
ENP Plating "ENP" • FKM Seals "V"

POPPET VALVES



MTV-3 shown

Port(s)	Toggle	2-Way	3-Way
#10-32	ENP Steel	MTV-2	MTV-3
1/8" NPT	ENP Steel	MTV-2P	MTV-3P

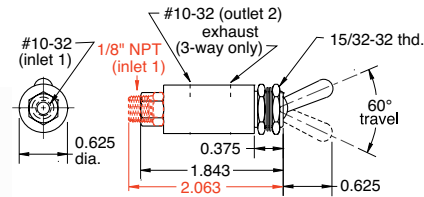

SPOOL VALVES



MTV-4F shown

Port(s)	Toggle	Exhaust	4-Way
#10-32	ENP Steel	To Atmosphere	MTV-4
#10-32	Plastic	To Atmosphere	MTV-4F
#10-32	ENP Steel	#10-32	MTV-5
#10-32	Plastic	#10-32	MTV-5F

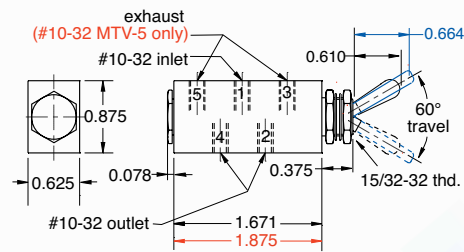

For high temperature applications (up to +400°F), or those that require special seals for chemical compatibility, Clippard offers optional FKM seals.

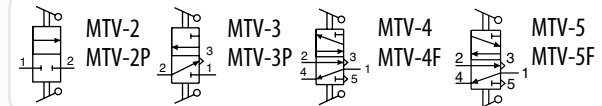

Same-Day Shipping

Hundreds of miniature cylinders, control valves, electronic valves, fittings and other products in stock and ready to ship! Order by **2:30 p.m. EST**

3-WAY #10-32 & 1/8" NPT TOGGLE VALVES

FTV SERIES

These 3-Way valves have a supply, outlet and exhaust port. When the toggle is in the "on" position air flows from the inlet to the outlet and the exhaust port is blocked. Moving the toggle to the "off" position closes the inlet and opens the outlet to an exhaust port which vents the outlet to atmosphere.

3-Way toggle valves may have a poppet or spool and by movement of the toggle may either be 2-position or have a momentary actuation.

Medium	Air
Force to Rotate Toggle	16 oz. nominal
Mounting	15/32-32 thread; nut and lockwashers furnished
Materials	Brass body, nitrile seals, stainless steel stem and spring

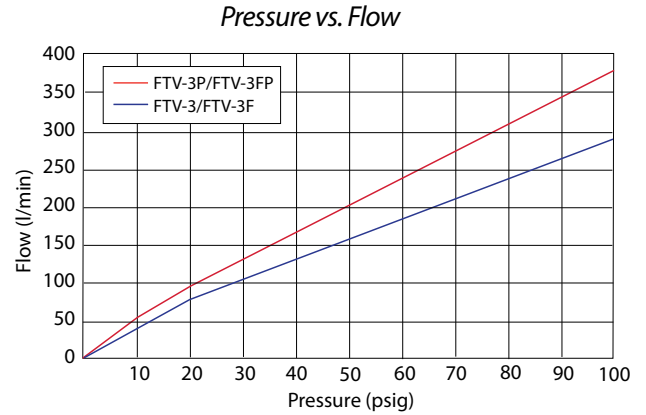

- Compact design
- Nickel-plated steel or plastic toggles



SPOOL VALVES



FTV-3 shown



FTV-3FP shown

Part No.	Ports	Air Flow	Toggle
FTV-3 FTV-3F	#10-32	170 l/min @ 50 psig; 280 l/min @ 100 psig	NP Steel Plastic
FTV-3P FTV-3FP	1/8" NPT	180 l/min @ 50 psig; 295 l/min @ 100 psig	NP Steel Plastic

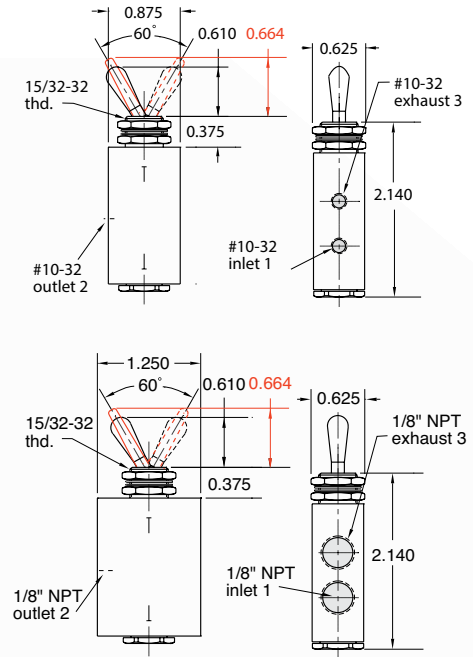

15/32 PANEL MOUNTING NUT



Brass with black or bright nickel finish

Part No.	
11406-1	Black
11406-2	Bright

3-WAY & 4-WAY 1/8" NPT TOGGLE VALVES

MJTV & HTV SERIES

3-Way valves have a supply, outlet and exhaust port. When the toggle is in the "on" position, air flows from the inlet to the outlet and the exhaust port is blocked. Moving the toggle to the "off" position closes the inlet and opens the outlet to an exhaust port which vents the outlet to atmosphere.

4-Way valves can supply and exhaust two different outlets and are commonly used with double-acting cylinders. When the toggle is in one position, air flows from the inlet to one of the outlets. The second outlet is open to the exhaust port which is vented to atmosphere. Moving the toggle to the opposite position opens the inlet to the second outlet while exhausting the first outlet. 4-Way ported valves can be plumbed in a dual pressure inlet configuration to save air consumption.

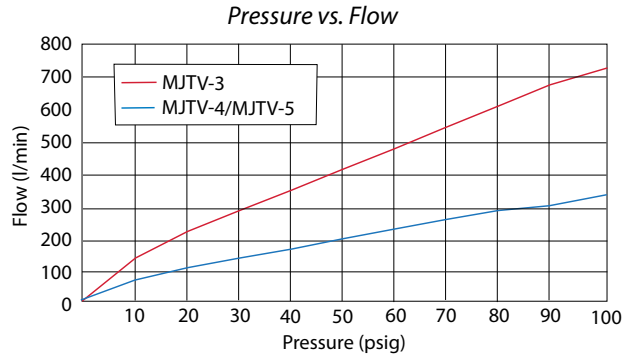

Medium	Air
Input Pressure	MJTV-3: 300 psig; MJTV-4/5: 150 psig max.
Force to Rotate Toggle	MJTV-4: 12 oz. MJTV-3, MJTV-5: 16 oz. nominal
Mounting	15/32-32 thread; nuts and lockwashers furnished
Materials	Brass body, nitrile seals, stainless steel stem and spring

MJTV N.C. 3-WAY 2-POSITION POPPET VALVE



Port(s)	Toggle	3-Way
1/8" NPT	ENP Steel	MJTV-3

Air Flow: 400 l/min @ 50 psig, 710 l/min @ 100 psig;

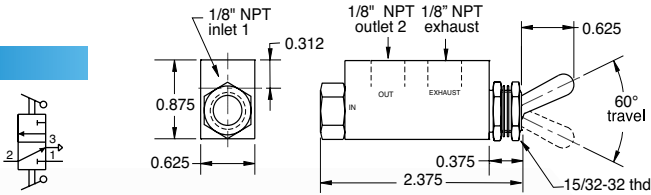

MJTV N.O./N.C. 4-WAY 2-POSITION VALVES



Port(s)	Toggle	4-Way
1/8" NPT	ENP Steel	MJTV-4
1/8" NPT	Plastic	MJTV-4F

Air Flow: 180 l/min @ 50 psig, 295 l/min @ 100 psig

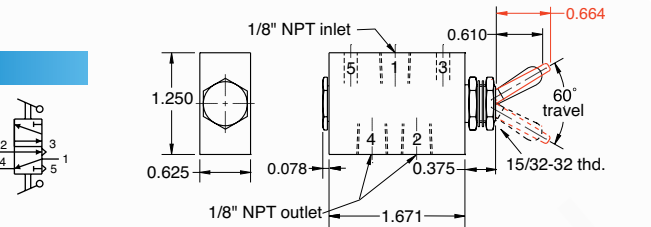

MJTV-4 shown

MJTV N.O./N.C. 4-WAY FULLY-PORTED SPOOL VALVES



Port(s)	Toggle	4-Way
1/8" NPT	ENP Steel	MJTV-5
1/8" NPT	Plastic	MJTV-5F

Air Flow: 180 l/min @ 50 psig, 295 l/min @ 100 psig

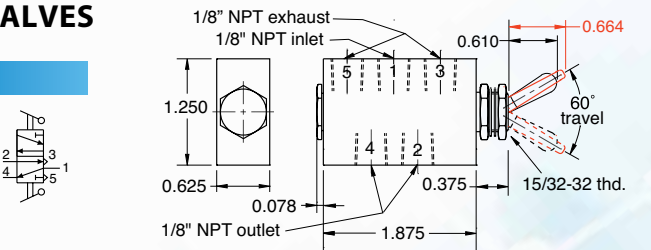

MJTV-5F shown

HTV TOGGLE VALVE

Minimum order quantities may apply.



Port(s)	Toggle	4-Way
Cartridge	NP Steel	HTV-4C

Air Flow: 180 l/min @ 50 psig; 330 l/min @ 100 psig

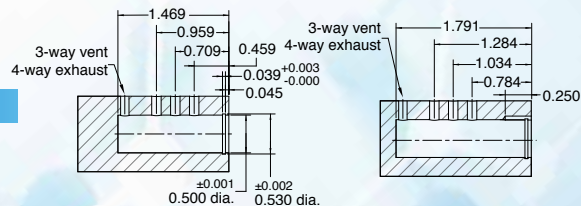

4-WAY #10-32 & 1/8" NPT TOGGLE VALVES

TV SERIES

4-Way 3-position toggle valve with outlet ports open to atmosphere in the center position. The valve can be spring centered, 3-position detent or the "DM" provides a detent on one side and spring return on the other side. The TV-DM model can be used on the momentary side as a "jog" or manual control, and with the detented side for an automatic or "run" mode.

Medium	Air
Input Pressure	150 psig max.
Materials	Brass body, nitrile seals, stainless steel spring
Air Flow	125 l/min @ 50 psig; 210 l/min @ 100 psig
Force to Rotate Toggle	8 oz. nominal
Mounting	5/8-32 thread, nut and lockwashers furnished

Pressure vs. Flow

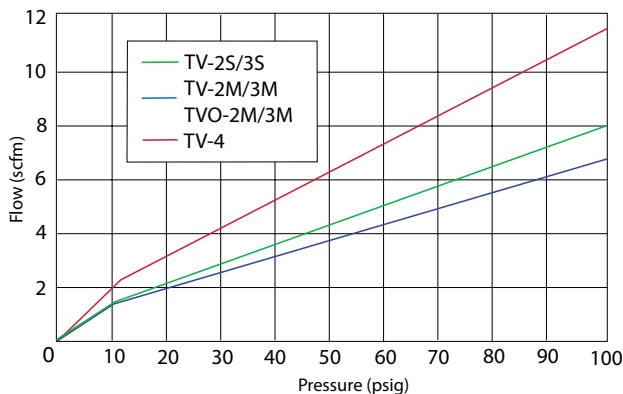

- Designed for use with Clippard manual, air pilot, electrical, or mechanical actuators

4-Way #10-32 Valves



TV-4D shown

Function	Toggle	4-Way
Detented/Detented	Plastic	TV-4D
Momentary/Momentary	Plastic	TV-4M
Detented/Momentary	Plastic	TV-4DM
Detented/Detented	ENP Steel	TV-4DH
Momentary/Momentary	ENP Steel	TV-4MH
Detented/Momentary	ENP Steel	TV-4DMPH

4-Way 1/8" NPT Valves



TV-4DH shown

Function	Toggle	4-Way
Detented/Detented	Plastic	TV-4DP
Momentary/Momentary	Plastic	TV-4MP
Detented/Momentary	Plastic	TV-4DMP
Detented/Detented	ENP Steel	TV-4DPH
Momentary/Momentary	ENP Steel	TV-4MPH
Detented/Momentary	ENP Steel	TV-4DMPH

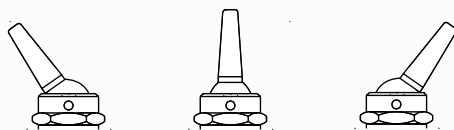
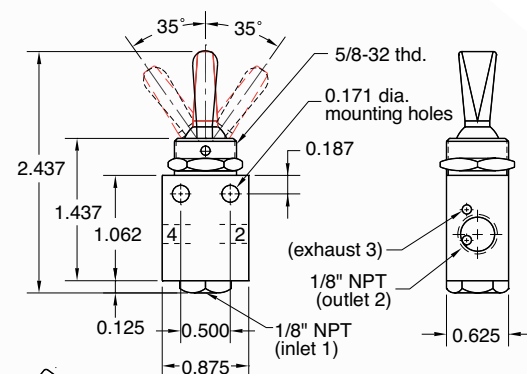
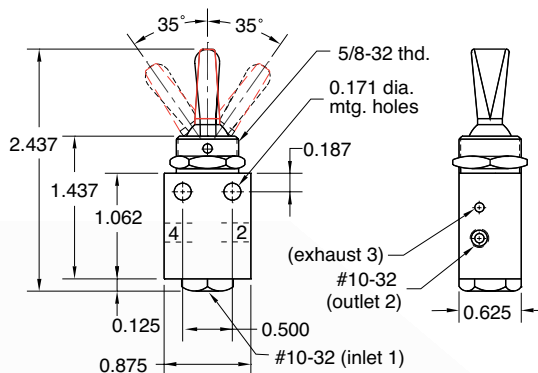

Model Number	Function	Toggle	4-Way
TV-4D	#10-32	Detented	Detented
TV-4DP	1/8" NPT	Detented	Detented
TV-4M	#10-32	Momentary	Momentary
TV-4MP	1/8" NPT	Momentary	Momentary
TV-4DM	#10-32	Detented	Momentary
TV-4DMP	1/8" NPT	Detented	Momentary



2-WAY, 3-WAY & 4-WAY #10-32 STEM & CARTRIDGE VALVES

MAV/MAVO & HV SERIES

The MAV series are #10-32 ported valves that change their flow path when the stem is depressed or released. The 2-Way and 3-Way valves are offered in both Normally-Closed (not passing) or Normally-Open (passing) versions. The 4-Way valves are typically used to control a double-acting air cylinder. Clippard offers a wide range of pneumatic and mechanical valve actuators that work with all Clippard stem valves.

Medium	Air, water, or oil
Input Pressure	MAV-2, MAV-3: 300 psig max. MAVO-2, MAVO-3, MAV-4: 150 psig max
Stem Travel	MAV-2, MAV-3: 1/8"; MAV-4: 3/16"
Force for Stem Travel	MAV-2, MAV-3: 24 oz.; MAVO-2, MAVO-3: 32 oz. MAV-4: 38 oz.; MAV-4D: 12 oz. nominal
Mounting	15/32-32 thread, nut and lockwashers furnished Cartridge inserts into 0.375" ±0.001" bore.
Materials	Brass body, nitrile seals, stainless steel stem and spring

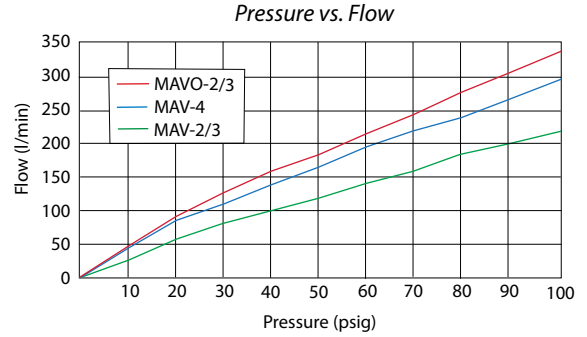

- Miniature size with high flow poppet or spool design
- Poppet valves provide superior life; spool valves provide superior versatility
- Rotatable inlet available

options (suffix)
ENP Plating "ENP" • FKM Seals "V"

MAV N.C. POPPET VALVES



MAV-3P shown

Inlet	Outlet	2-Way	3-Way
#10-32	#10-32	MAV-2	MAV-3
1/8" NPT	#10-32	MAV-2P	MAV-3P

Air Flow: 113 l/min @ 50 psig; 190 l/min @ 100 psig

MAVO N.O. SPOOL VALVES



MAVO-2P shown

Inlet	Outlet	2-Way	3-Way
#10-32	#10-32	MAVO-2	MAVO-3
1/8" NPT	#10-32	MAVO-2P	MAVO-3P

Air Flow: 170 l/min @ 50 psig; 280 l/min @ 100 psig

MAV 4-WAY SPOOL VALVES



MAV-4 shown

Inlet	Outlet	Actuation	4-Way
#10-32	#10-32	Spring Return	MAV-4
#10-32	#10-32	2-Position	MAV-4D

Air Flow: 140 l/min @ 50 psig; 240 l/min @ 100 psig

MAV & MAVO N.O. & N.C. CARTRIDGE VALVES



Function	2-Way	3-Way
Normally-Closed	MAV-2C	MAV-3C
Normally-Open	MAVO-2C	MAVO-3C

Air Flow: 85 l/min @ 50 psig; 170 l/min @ 100 psig

HV STEM VALVE

Ports	4-Way
#10-32	HV-4C

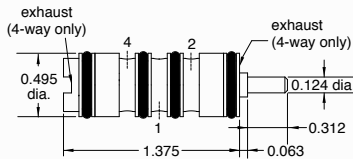

Air Flow: 180 l/min @ 50 psig; 330 l/min @ 100 psig



Minimum order quantities may apply.

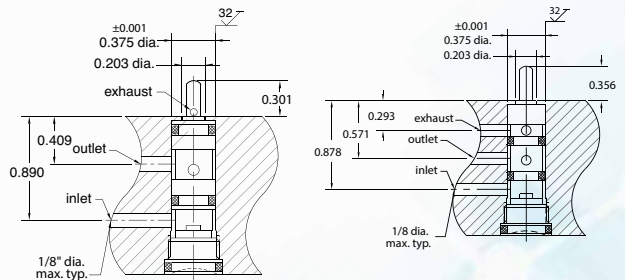

Cavity Drawings—MAV-2C/3C (above, left); MAVO-2C/3C (above, right)

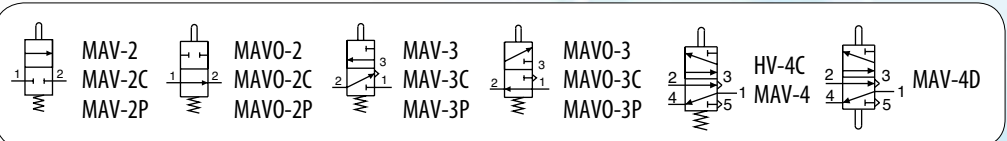

3-WAY & 4-WAY #10-32 & 1/8" NPT STEM VALVES

FV SERIES

These balanced spool valves are fully-ported, which means that all ports are usable and can handle pressure or vacuum or both. The FV-3 is a 3-Way but can be used as a 2-Way Normally-Open or Closed by plugging port 2 or 4. As a 3-Way it can be connected as a Normally-Closed, Normally-Open and as a selector or diverter. The FV-5 can be connected in a dual pressure inlet configuration.

Medium	Air, oil, or water
Input Pressure	150 psig max.
Stem Travel	1/8"
Force for Full Stem Travel	FV-3, FV-3P, FV-4, FV-4P, FV-5, FV-5P: 4.5 pounds nominal FV-3D, FV-3DP, FV-4D, FV-4DP, FV-5D, FV-5DP: 1.5 pounds nominal
Mounting	15/32-32 thread, nuts and lockwashers furnished
Materials	Brass body, nitrile seals, stainless steel stem and spring

Pressure vs. Flow

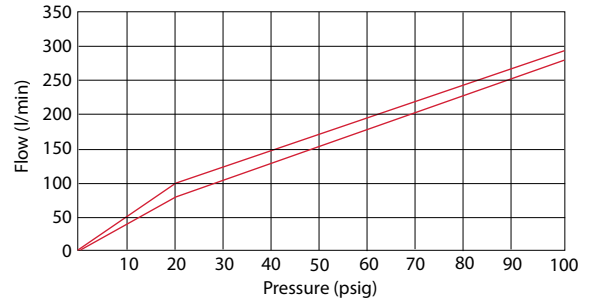

- Designed for use with Clippard manual, air pilot, electrical, or mechanical actuators

options (suffix)
ENP Plating "-ENP" • FKM Seals "-V"

3-WAY VALVES



FV-3D shown

Port(s)	Actuation	3-Way
#10-32	Spring Return	FV-3
#10-32	2-Position	FV-3D
1/8" NPT	Spring Return	FV-3P
1/8" NPT	2-Position	FV-3DP

Air Flow: FV-3/3D: 170 l/min @ 50 psig; 280 l/min @ 100 psig;
FV-3P/3DP: 180 l/min @ 50 psig; 295 l/min @ 100 psig

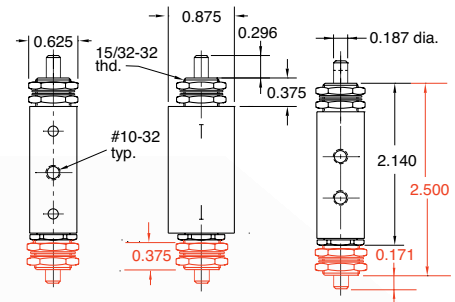

4-WAY VALVES



FV-4 shown

Port(s)	Actuation	4-Way
#10-32	Spring Return	FV-4
#10-32	2-Position	FV-4D
1/8" NPT	Spring Return	FV-4P
1/8" NPT	2-Position	FV-4DP

Air Flow: FV-4/4D: 170 l/min @ 50 psig; 280 l/min @ 100 psig;
FV-4P/4DP: 180 l/min @ 50 psig; 280 l/min @ 100 psig

4-WAY FULLY-PORTED VALVES



Port(s)	Actuation	Exhaust	4-Way
#10-32	Spring Return	-	FV-5
#10-32	2-Position	-	FV-5D
1/8" NPT	Spring Return	1/8" NPT	FV-5P
1/8" NPT	2-Position	1/8" NPT	FV-5DP

Air Flow: FV-5/5D: 170 l/min @ 50 psig; 280 l/min @ 100 psig;
FV-5P/5DP: 180 l/min @ 50 psig; 295 l/min @ 100 psig

FLOW PATHS FOR FTV & FV SERIES VALVES

Solid lines indicate flow paths with toggle or stem in one direction. Dotted lines indicate flow paths when the toggle or stem are shifted.

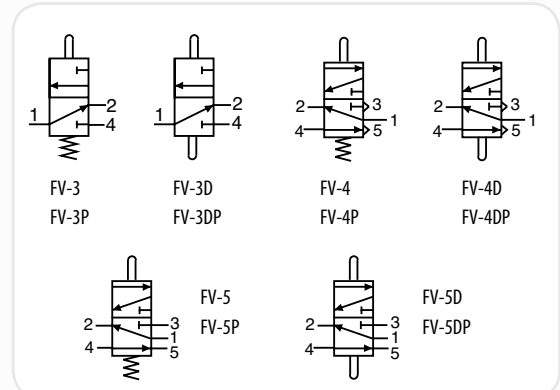
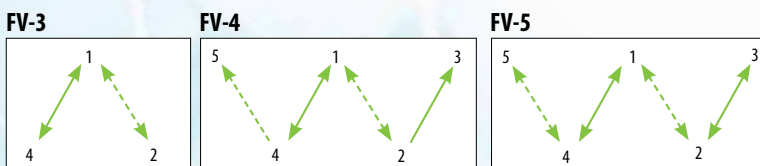

2-WAY, 3-WAY & 4-WAY 1/8" NPT STEM & CARTRIDGE VALVES

MJV/MJVO SERIES

These are high flow 1/8" NPT ported 2-Way, 3-Way and 4-Way valves that change their flow path when the stem is either depressed or released (spring return). The 2-Way and 3-Way valves are offered in both Normally-Closed (not passing) or Normally-Open (passing) versions. The 4-Way valves are typically used to control a double-acting air cylinder. We offer a wide range of pneumatic and mechanical valve actuators (see pp. 90-92) that work with all Clippard stem valves.

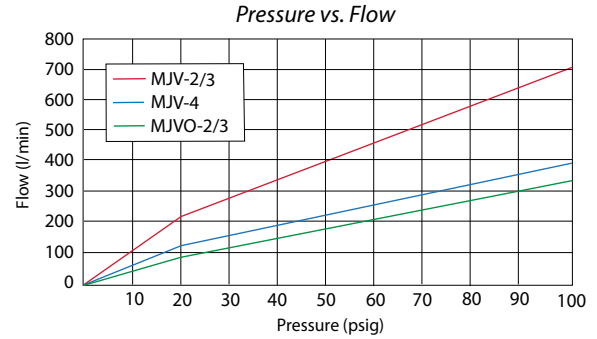

Medium	Air, water, oil, or other compatible fluids
Input Pressure	MJVO-2, MJVO-3, MJV-4, MJV-4D: 150 psig max. MJV-2, MJV-3, MJVO-3C: 300 psig max.
Stem Travel	1/8"; MJV-4: 3/16"
Force for Full Stem Travel	MJV-4D: 12 oz.; MJV-2C, MJVO-2C: 24 oz.; MJV-2: 36 oz.; MJV-2, MJV-3, MJVO-3, MJV-4: 38 oz. nominal
Mounting	15/32-32 thread, nut and lockwashers furnished. MJV-4 and MJV-4D also have two mounting holes in body. Cartridge version inserts into a 0.625" ±0.001" bore.
Materials	Brass body, nitrile seals, stainless steel stem and spring

- High flow poppet or spool design
- MJV-2 or MJV-3 are Normally-Closed (no flow when not actuated)
- MJVO-2 or MJVO-3 are Normally-Open (flowing until actuated)
- Cartridge valves are designed to be installed in a custom bore

NORMALLY-OPEN/NORMALLY-CLOSED POPPET VALVES



Port(s)	Function	2-Way	3-Way
1/8" NPT	Normally-Closed	MJV-2	MJV-3
1/8" NPT	Normally-Open	MJVO-2	MJVO-3

Air Flow: MJV-2, MJV-3: 400 l/min @ 50 psig; 710 l/min @ 100 psig;
MJVO-2, MJVO-3: 200 l/min @ 50 psig; 340 l/min @ 100 psig

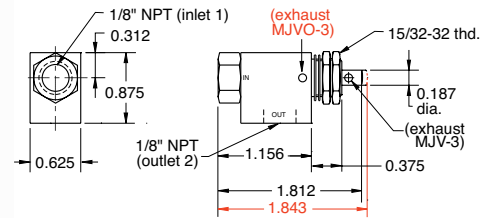

2-WAY & 3-WAY CARTRIDGE VALVES



Function	2-Way	3-Way
Normally-Closed	MJV-2C	MJV-3C
Normally-Open	MJVO-2C	MJVO-3C

Air Flow: MJV-2/3C: 10 l/min @ 50 psig; 620 l/min @ 100 psig;
MJVO-2C/3C: 225 l/min @ 50 psig; 400 l/min @ 100 psig

NORMALLY-OPEN SPOOL VALVES



Port(s)	Actuation	4-Way
1/8" NPT	Spring Return	MJV-4
1/8" NPT	2-Position	MJV-4D

Air Flow: 225 l/min @ 50 psig; 400 l/min @ 100 psig

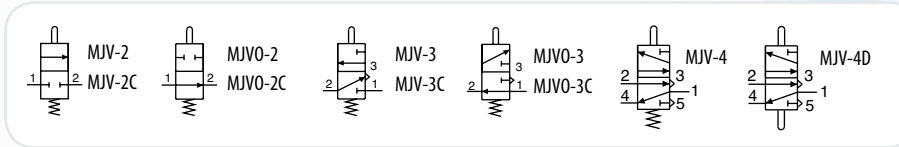
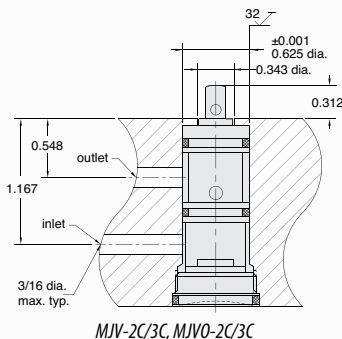

Clippard miniature cartridge valves offer the user flexibility in the application of 2-Way and 3-Way Normally-Open or Normally-Closed valves. They are used in Clippard heavy-duty limit switches and are suitable for pneumatic tools and manifolds or for any use where a valve needs to be built in.

HIGH FLOW 2-WAY & 3-WAY TOGGLE, STEM & CARTRIDGE VALVES

GV SERIES

The GV series valves offer 10 times more flow than the MAV series and 2.5 times the flow of the MJV series. With Clippard's versatile 15/32-32 nose thread, a large variety of buttons and valve actuators can be used with the stem operated valves. The GTV series are toggle valves with panel mounting capabilities (5/8-32 nose thread). The outlet port on all GV valves can be easily positioned to any orientation for mounting convenience.

Medium	2-Way: Air, water, or oil 3-Way: Air
Input Pressure	150 psig max.
Air Flow	1,070 l/min @ 50 psig; 1,900 l/min @ 100 psig
Ports	1/4" NPT, 3/8" Push-Quick, Cartridge
Force for Full Stem Travel	9 lbs. nominal @ 100 psig
Mounting (Cartridge Style)	Inserts into a 0.687" bore
Materials	Stem: Stainless steel Toggle: Nickel-plated steel

Pressure vs. Flow

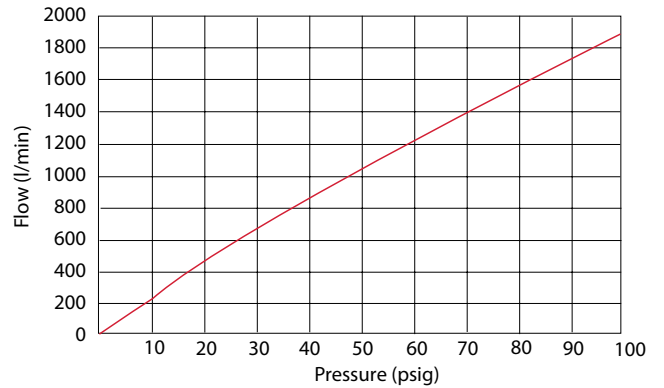

- Will accept a variety of manual, air pilot, electrical or mechanical actuators
- Design flexibility and fast response
- Corrosion-resistant series also available

options (suffix)
ENP Plating "ENP" • FKM Seals "V"



2-WAY & 3-WAY TOGGLE VALVES, 1/4" NPT

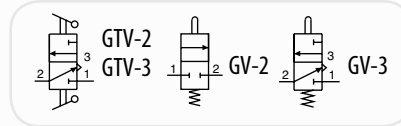
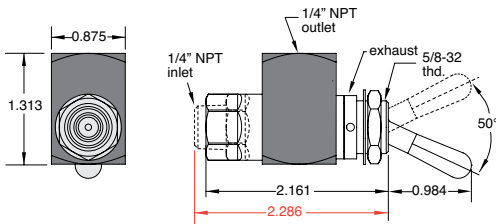

Inlet	Outlet	2-Way	3-Way
1/4" NPTF	1/4" NPTF	GTV-2	GTV-3
1/4" NPTM	1/4" NPTF	GTV-2Q	GTV-3Q

2-WAY & 3-WAY TOGGLE VALVES

1/4" NPT, 3/8" Push-Quick Fittings



Inlet	Outlet	2-Way	3-Way
1/4" NPTM	3/8" PQ	GTV-2Q-P12	GTV-3Q-P12
3/8" PQ	3/8" PQ	GTV-2-P12	GTV-3-P12

(GTV-3Q-P12 shown)

2-WAY & 3-WAY STEM VALVES

1/4" NPT, 3/8" Push-Quick Fittings



Inlet	Outlet	2-Way	3-Way
1/4" NPTM	3/8" PQ	GV-2Q-P12	GV-3Q-P12
3/8" PQ	3/8" PQ	GV-2-P12	GV-3-P12

(GV-3-P12 shown)

2-WAY & 3-WAY STEM VALVES, 1/4" NPT



Inlet	Outlet	2-Way	3-Way
1/4" NPTF	1/4" NPTF	GV-2	GV-3
1/4" NPTM	1/4" NPTF	GV-2Q	GV-3Q

(GV-2 shown)

2-WAY & 3-WAY STEM CARTRIDGE VALVES



2-Way	3-Way
GV-2C	GV-3C

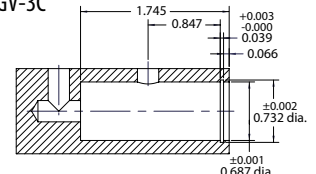



SLEEVE VALVES, LIMIT VALVES & ACTUATOR ARMS

SLEEVE VALVES

Clippard J-Series sleeve valves offer large flow capability with a relatively short stroke in 2-Way and 3-Way valves, and no cross-over between inlet and exhaust on the 3-Way models. Unlike ball valves, sleeve valves require no space for a handle. They also provide flexibility in pipe connections and are available with either male or female threads or combinations of both.

The JSLV-2 valves feature a smooth opening stroke during which inlet air is directed to the outlet. During the closing stroke, in the opposite direction of travel, the outlet is closed from the inlet and in the JSLV-3 version, the outlet is then exhausted to atmosphere without the inlet ever being connected to exhaust.

Part No.	Type	Inlet	Outlet	Air Flow
 SLV-2	2-Way	#10-32 Female	#10-32 Female	330 l/min @ 100 psig
JSLV-2-F2M2		1/8" NPT Female	1/8" NPT Male	1,200 l/min @ 100 psig
JSLV-2-M2F2		1/8" NPT Male	1/8" NPT Female	1,200 l/min @ 100 psig
JSLV-2-F4M4		1/4" NPT Female	1/4" NPT Male	2,000 l/min @ 100 psig
JSLV-2-M4F4		1/4" NPT Male	1/4" NPT Female	2,000 l/min @ 100 psig
 SLV-3	3-Way	#10-32 Female	#10-32 Female	330 l/min @ 100 psig
JSLV-3-F2M2		1/8" NPT Female	1/8" NPT Male	1,200 l/min @ 100 psig
JSLV-3-M2F2		1/8" NPT Male	1/8" NPT Female	1,200 l/min @ 100 psig
JSLV-3-F4M4		1/4" NPT Female	1/4" NPT Male	2,000 l/min @ 100 psig
JSLV-3-M4F4		1/4" NPT Male	1/4" NPT Female	2,000 l/min @ 100 psig

Medium Air, water, or oil (SLV- air only)
Material Electroless nickel plated brass body
Input Pressure 150 psig
Mounting In-line or direct
Force to Actuate Approx. 2.5 lbs.
Stem Travel 1/8"

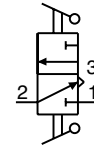

HEAVY DUTY LIMIT VALVES

These valves feature rugged construction to withstand heavy use. A zinc alloy die cast actuator head with a hardened steel shaft in a bronze bearing is mated to a solid aluminum valve body. Inside is an easy-to-replace Clippard MJV series (see p. 86) cartridge valve made of brass and stainless steel with nitrile seals.



Medium	Air
Stem Travel	Actuator arm may move 50° in either direction
Input Pressure	300 psig max.
Air Flow	280 l/min @ 50 psig; 540 l/min @ 100 psig
Torque to Actuate	3 in.-lbs.
Actuation Range	0 to 23° off; 23 to 50° on; max. travel 50°
Ports	Inlet: 1/8-27" NPT; Outlet: 1/8-27" NPT; Exhaust (3-Way Only): 1/8-27" NPT for convenience in porting away exhaust air or attaching muffler <i>Exhaust should not be restricted</i>

Part No.	Description
LVA-2	2-Way Poppet Normally-Closed Limit Valve
LVA-3	3-Way Poppet Normally-Closed Limit Valve
LVA0-2	2-Way Normally-Open Limit Valve
LVA0-3	3-Way Normally-Open Limit Valve

ROLLER ACTUATOR ARMS



Arm	Aluminum base; AR-L: Steel extendable arm
Roller	Hardened steel
Adjustment	AR-L Only: 1.0" to 3.5"
Mounting	Slotted mounting clamp tightens onto limit valve with 5/32" hex wrench, may be positioned on limit valve shaft in any direction (rotates 360°)

Part No.	Description
AR-K	Roller Actuator Arm
AR-L	Roller Actuator Arm, Adjustable

ADJUSTABLE ROD ACTUATOR ARM



Arm	Steel 1/8" rod, 13" long, retained by screw clamp; may be shortened and/or bent to desired shape
Mounting	Slotted aluminum mounting clamp may be positioned on limit valve shaft in any direction (rotates 360°)

Part No.	Description
AR-M	Rod Actuator Arm

ACTUATORS

SINGLE-ACTING AIR PILOT ACTUATORS

Construction Brass and aluminum body, stainless steel springs, nitrile seals, Delrin® piston

Mounting 15/32-32 female thread to mount to Clippard Minimatic® valves and components; no spacers or washers are required when assembled to any Clippard valve; may be used with **15018-2** mounting bracket

	Part No.	Port	Bore Size	Force Factor	Input Pressure
	MPA-3* MPA-3P*	#10-32 1/8" NPT	0.375"	0.1	250 psig
<i>*0.125" spacer required when assembled on MAV-2, MAV-3, and MAV-4</i>					
	MPA-5 MPA-5P	#10-32 1/8" NPT	0.625"	0.3	250 psig
	MPA-7	1/8" NPT	0.875"	0.6	250 psig
	MPA-10 MPA-10P	#10-32 1/8" NPT	1.250"	1.2	150 psig

MINIMUM PRESSURE REQUIRED

Clippard Valve	Pressure (psig)*			
	MPA3	MPA-5	MPA-7	MPA-10
ES-1 Switch	12	4	2	n/a
FV-3/3P/4/4P/5/5P	41	15	7.5	4.0
FV-3D/3DP/4D/FV-4DP/5D/5DP	14	5	2.5	1.5
GV-2/3	87	31	16	8.0
MAV-2/3	23	8	4	2.0
MAV-4/MJV-4	36	11	5.5	3.5
MAV-4D/MJV-4D	13	4	1.5	1.0
MJV-2/3	30	10	5	3.0
MAVO-2/3	27	9	4.5	2.5
MJVO-2/3	30	10	5	3.0
HV-4	41	15	7.5	4.0

*With 100 psig to valve inlet

MBA-1, 11925 & 12296

When mounting on a valve, a space should be provided between the body and the actuator according to the chart shown here.

Valve Mtg. Thd.	MBA-1	11925	12296
0.250 thd. length	0.125"	0.062"	0.062"
0.373 thd. length	0.218"	0.188"	0.188"

Mounting nut (supplied with valve), mounting bracket or washers should be used to obtain required spacing.

PUSH BUTTON ACTUATORS



Construction Brass body

Use Mounts directly on valve stem for manual operation of valve; small size permits attachment to valve before valve is mounted through 15/32" dia. hole; prevents over-travel of valve stem by providing a positive stop

Mounting 1/8" or 3/16" dia. mounting hole fits valve stems; locks in place by set screw (allen wrench furnished)

Part No. Description

11916-1	5/8" Brass Push Button, 1/8" Stem
11916-2	5/8" Brass Push Button, 3/16" Stem
11916-3	13/32" Brass Push Button, 1/8" Stem
11916-4	13/32" Brass Push Button, 3/16" Stem

ROLLER CAM ACTUATORS

Construction Stainless steel with nylon roller

Use Mounts to valve body; **11925** actuates valve when mechanically depressed, valve spring provides return; **12296** actuates valve when depressed by activating cam or linear travel device in one direction only, no actuation on return travel



Mounting 31/64" dia. mounting hole fits 15/32-32 threaded mounting section of valve body

Part No. Description

11925	Roller Cam Follower
12296	Roller, Double-Pivoted 1-Way Cam Follower

BALL CAM ACTUATORS

Ball Cam Actuator permits the valves and electrical switch to be operated by mechanical movement depressing the ball from any direction.



Construction Brass body, stainless steel ball retained in housing

Operation Will actuate valve when depressed from any (360°) direction

Mounting 15/32-32 female to mount to Clippard valves and electric switches

Part No. Description

MBA-1	Ball Cam Actuator
-------	-------------------

PUSH BUTTON ACTUATORS

Clippard offers captivated push buttons for use with a large variety of stem operated valves. Captivated push buttons are sold as kits, adaptable to either 1/8" diameter stems or 3/16" diameter stems. Each kit includes a colored acetyl push button, brass housing nut, 1/16" brass spacer, and lock washer for assembly.

Captivated push buttons can be used on individual stem operated valves or in panel mount application by omitting the 1/16" brass spacer. These push buttons are available in a variety of colors, allowing you to color code and easily differentiate between valves when designing control systems.

The design of these push buttons allows maximum actuation of the valve with no over-travel or side load to the valve stem. This assures superior performance and long life.

Captivated push buttons are commonly used as limit valves in conjunction with pneumatic cylinders, slides, and any variety of mechanical actuators. The rugged design coupled with precise actuation of stem operated valves make it perfect for applications where repetitive cycling of the valve is necessary. Designed to work with Clippard MAV (p. 85), MJV (p. 87), and FV (p. 86) series valves.

CAPTIVATED PUSH BUTTON ACTUATORS

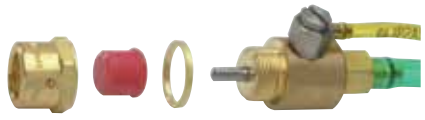

		Valve Stem	Part No.		
	Extended Button	1/8" dia.	PC-1□*		Color Options* B - ● W - ○ R - ● G - ● Y - ●
		3/16" dia.	PC-2□*		
			<i>Enter color choice in box (Ex: PC-1R)</i>		

Heavy-duty push button actuators can be used on individual stem operated valves or in panel mounting applications. These push buttons are available in a variety of colors, allowing you to color code, or easily differentiate between valves when designing control systems. They feature a built-in spring so the button always returns to the extended position when released with no additional load on the valve.

The design of these push buttons allows complete actuation of the valve with no over-travel or side load to the valve assuring superior performance and long life.









HEAVY-DUTY ACTUATORS

		Mtg. Thread	Part No.			Mtg. Thread	Part No.
	Extended Button	5/8-32	PC-3E-□*		Mushroom Button	5/8-32	PC-3M-□*
		7/8-32	PC-4E-□*			7/8-32	PC-4M-□*
		1 3/16-28	PC-5E-□*			1 3/16-28	PC-5M-□*
	Flush Button	5/8-32	PC-3F-□*	Color Options*			
		7/8-32	PC-4F-□*	BK - ● WH - ○ RD - ● GN - ●	YL - ● BL - ● OR - ● GR - ●		
		1 3/16-28	PC-5F-□*	<i>Non-standard colors also available</i>			

ACTUATORS

CONTROL VALVE & ACTUATOR ASSEMBLIES

22 mm	Description	Function	Part No.	Color
	Flush Push Button	Manual push in, spring return	P22-P2F-R P22-P2F-G P22-P2F-B P22-P2F-Y	● ● ● ●
	Extended Push Button	Manual push in, spring return	P22-P2E-R P22-P2E-G P22-P2E-B P22-P2E-Y	● ● ● ●
	Automatic Push/Turn Mushroom	Manual push in, latches in, turn clockwise to unlock, spring return	P22-L3M-R P22-L3M-G P22-L3M-B	● ● ●
	Maintained Twist 90°	Turn clockwise to latch in, turn counter-clockwise to release	P22-T3T-B	●

22 mm	Description	Function	Part No.	Color
	Spring Return Twist 45°	Turn clockwise and hold for in, release for spring return	P22-T2T-B	●
	Manual Push Mushroom	Manual push in, spring return	P22-P2M-R P22-P2M-G P22-P2M-B	● ● ●
	Key Twist 90° Maintained (with keys)	Turn clockwise to latch in, counter-clockwise to release, key withdrawable ^{1,2}	P22-T3K-B ¹ P22-K3K-B ²	● ●
	Push Key Mushroom (with keys)	Manual push in, auto latch in, clockwise to release, key withdrawable ²	P22-L4M-R ²	●

30 mm	Description	Function	Part No.	Color
	Flush Push Button	Manual push in, spring return	PL-P2F-R PL-P2F-G PL-P2F-B PL-P2F-Y	● ● ● ●
	Extended Push Button	Manual push in, spring return	PL-P2E-R PL-P2E-G PL-P2E-B PL-P2E-Y	● ● ● ●
	Maintained Twist 90°	Clockwise to latch in, counter-clockwise to release	PL-T3T-B	●
	Manual Push Mushroom	Manual push in	PL-P2M-R PL-P2M-G PL-P2M-B	● ● ●

30 mm	Description	Function	Part No.	Color
	Push/Turn Mushroom	Manual push in, clockwise to unlatch	PL-L3M-R PL-L3M-G PL-L3M-B	● ● ●
	Spring Return Twist 45°	Clockwise and hold for in, release for return	PL-T2T-B	●
	Push Key Maintained	Manual push in, counter-clockwise to lock out, clockwise to unlock	PL-P2K-B	●
	Key Maintained Twist 90° (with keys)	Clockwise to latch in, counter-clockwise to release	PL-T3K-B	●

3-WAY & 4-WAY MANUALLY-OPERATED VALVES

PUSH/PULL SPOOL VALVES

Operating Pressure 0 to 115 psig
Cv 0.89
Ports 1/4" NPT,
1/8" NPT exhaust
Operating Temp. 32 to 140°F
Mounting Panel or base mount



Part No.	Description
MMV-P3QD	3-Way, 3 Port Detented Push/Pull Valve
MMV-P4QD	4-Way, 5 Port Detented Push/Pull Valve
MMV-P4QM	4-Way, 5 Port Momentary Push/Pull Valve

FOOT PEDAL VALVES

Two versions available—low-profile flat pedal or standard pedal, with or without guard.

Operating Pressure 0 to 150 psig
Cv 1.4
Ports 1/4" NPT
Operating Temp. 32 to 140°F
Mounting Base mount



Part No.	Description
MMV-F3QM-F	3-Way Valve with Flat Pedal
MMV-F4QM-F	4-Way Valve with Flat Pedal
MMV-F4QM	4-Way Valve with Standard Pedal
MMV-F4QM-6	4-Way Valve with Plastic Foot Guard

3-WAY PALM BUTTON VALVES

Medium Air
Stem Travel 1/8"
Input Pressure 100 psig max.
Air Flow 99 l/min @ 50 psig
170 l/min @ 100 psig
Force to Actuate 1.75 lbs. manual
Ports 1/8" NPT (exhaust may be muffled or piped away but not restricted)
Mounting Mounting holes provided



Part No.	Description
PB-1-RD	3-Way Poppet Valve, Red
PB-1-GN	3-Way Poppet Valve, Green
PB-1-BK	3-Way Poppet Valve, Black
12959	90° Mounting Bracket Kit

LEVER VALVES

Operating Pressure 0 to 150 psig
Cv Detented: 1.0,
Momentary: 0.89
Ports 1/4" NPT
Operating Temp. 32 to 140°F
Mounting Panel or base mount



Part No.	Description
MMV-L3QD	3-Way, 2-Position Detented Valve
MMV-L3QM	3-Way, 2-Position Momentary Valve
MMV-L4QD	4-Way, 2-Position Detented Valve
MMV-L4QD-C	4-Way, 2-Position Detented Valve, Closed Center
MMV-L4QD-E	4-Way, 2-Position Detented Valve, Exhaust Center
MMV-L4QD-P	4-Way, 2-Position Detented Valve, Pressure Center
MMV-L4QM	4-Way, 2-Position Momentary Valve
MMV-L4QD-C	4-Way, 3-Position Detented Valve, Closed Center
MMV-L4QD-E	4-Way, 3-Position Detented Valve, Exhaust Center
MMV-L4QD-P	4-Way, 3-Position Detented Valve, Pressure Center

3-WAY LOW FORCE PALM BUTTON VALVES

Medium Air
Input Pressure 100 psig max.
Air Flow 620 l/min @ 100 psig
Bleed 2.8 l/min @ 100 psig
Force to Actuate 1.0 oz. manual
Ports 1/8" NPT (exhaust may be muffled or piped away but not restricted)
Mounting Mounting holes provided



Part No.	Description
PB-2-RD	Low Force 3-Way Poppet Valve, Red
PB-2-GN	Low Force 3-Way Poppet Valve, Green
PB-2-BK	Low Force 3-Way Poppet Valve, Black
2010-050	Mounting Bracket

Air Pilot Valves



LOW PRESSURE AIR PILOT VALVES

- N.O. or N.C. air pilot valves
- Amplifier valves
- Bleed pressure piloted limit valves
- Electronically piloted valves

pp. 96-97



BRASS AIR PILOT VALVES

- PAV/PAVO Series
- Normally-Open or Normally-Closed
- 2-Way and 3-Way configurations

p. 98



MAXIMATIC® AIR PILOT VALVES

- Spool type valves with single or double air pilots
- Maximum flow, maximum value
- 3-Way and 4-Way configurations

pp. 99-101



MODULAR VALVES

- Available in an unlimited variety of directional, low pressure, and special control valves
- The supreme "plug-and-play" devices for pneumatic applications

pp. 102-113

PROBLEM

Sometimes, it's all about the timing. In this case, a retrofit to an old machine was needed—fast! The OEM sought a partner who could help modify an existing design and meet a tight deadline.

SOLUTION

In these types of situations, the Clippard modular valve works wonders. These valves mount and link together with a special piping system which eases assembly and plumbing, provides reduced labor costs, minimizes errors in installation, and eliminates potential leak points. Clippard modular valves have been uniquely designed to enable multiple valve elements to be contained within a single valve body. This provides incredible flexibility and variety, allowing Clippard modular valves to accomplish a myriad of control challenges.

In this case, Clippard modular valves were specially configured to meet the requirements of this particular application and mounted on a special acrylic subplate, thereby greatly simplifying redundant circuitry. The OEM's new circuit improved the performance and maintenance of their system and shipped in time to meet their deadline.

WHAT CAN CLIPPARD DO FOR YOU?

877-245-6247



LOW PRESSURE AIR PILOT VALVES

3-WAY N.C. AMPLIFIER VALVES



Amplifies very low pressure air-jet sensing signals to working power levels

Part No.	Description
2010	Normally-Closed Interface, 1/8" NPT
2010-050	Flat Mounting Bracket

Medium	Air
Material	Anodized aluminum body, nitrile diaphragms
Input Pressure	30 to 100 psig
Air Flow	620 l/min @ 100 psig
Pilot Pressure	4" H ₂ O @ 100 psig
Max. Pilot Pressure	5 psig
Filtration	10 micron
Response Time	10 ms dead headed
Operating Speed	50 Hz
Bleed	2.8 l/min @ 100 psig
Ports	Load, Supply & Exhaust: 1/8" NPT female Control: #10-32 female

3-WAY BLEED PRESSURE PILOTED LIMIT VALVES



Blocking of the sensing port causes rapid valve opening

Part No.	Description
2011	Piloted Limit Valve, 1/8" NPT
2011-012	Replacement #10-32 rubber nozzles
2010-050	Flat Mounting Bracket

Medium	Air
Material	Anodized aluminum body, nitrile diaphragms
Input Pressure	30 to 100 psig max.
Air Flow	620 l/min @ 100 psig
Filtration	10 micron
Bleed	2.8 l/min @ 100 psig
Response Time	15 ms
Ports	1/8" NPT

3-WAY N.O. OR N.C. AIR PILOT VALVES



Blocking of the sensing port causes rapid valve opening

Part No.	Description
2012	Piloted Valve, 1/8" NPT
2012-VAC	Valve for Vacuum Operation <i>Requires positive pressure pilot signal</i>
2012-G	Valve for Liquid Adhesives <i>Silicone diaphragm and seals, 1/8" NPT</i>
2010-050	Flat Mounting Bracket

Medium	Air
Material	Anodized aluminum body, nitrile diaphragms
Input Pressure	1 to 100 psig max.
Air Flow	620 l/min @ 100 psig
Pilot Pressure	20 psig min. or N.O. 90% of Supply, N.C. 60% of Supply (<i>whichever is greater</i>)
Response Time	15 ms after pilot pressure reaches switch point
Operating Speed	1,100 CPM

LOW PRESSURE AIR PILOT VALVES

3-WAY N.O. OR N.C. ELECTRONICALLY PILOTED VALVES



Low-power DC solenoid can be directly converted to high pressure pneumatic power without electronic amplification.

Part No.	Description
2013-6	Valve, 6 VDC, 1/8" NPT
2013-12	Valve, 12 VDC, 1/8" NPT
2013-24	Valve, 24 VDC, 1/8" NPT
2010-050	Flat Mounting Bracket

Medium	Air
Material	Anodized aluminum body, nitrile diaphragms
Input Pressure	30 to 100 psig max.
Air Flow	620 l/min @ 100 psig
Bleed	2.8 l/min @ 100 psig
Filtration	10 micron
Frequency Response	50 Hz @ 100 psig; 70 Hz @ 30 psig
Switching Speed	10 ms
Leads	28 gauge stranded PVC insulated
Continuous Overload	350% @ 25°C; 250% @ 50°C (ambient)
Power Consumption	< 0.50 W at rated voltage 80 ma. @ 6V, 40 ma. @ 12V, 20 ma. @ 24V

PRESSURE PILOTED SNAP ACTION AMPLIFYING VALVE



Provides a sharp, clean output signal, even with slow-changing pressure input signals; output is stabilized without chatter or oscillation.

Part No.	Description
3200-A	Amplifying Valve, #10-32
3200-006	Mounting Bracket

Medium	Air
Input Pressure	3 to 100 psig max.
Min. Pilot Pressure	1.5" H ₂ O
Max. Pilot Pressure	1 psig (28" H ₂ O)
Air Flow	5.1 l/min @ 100 psig;
Bleed Orifice	0.010" diameter

3-WAY N.C. PRESSURE PILOTED VALVES



Designed to be piloted by a Clippard EV or ET manifold mount electronic valve. Output from the EV/ET actuates the valve to produce outputs up to 620 l/min at 100 psig. Combines low wattage, long life and cool running of the EV/ET valves with quick response and high flow of Clippard booster type valves.

Part No.	Description
2020	Piloted Valve, External Port
2021	Piloted Valve, Internal Port
2010-050	Flat Mounting Bracket

Medium	Air
Input Pressure	30 to 100 psig max.
Air Flow	620 l/min @ 100 psig
Pilot Pressure	60% of supply pressure, minimum
Response Time	Approx. 20 milliseconds
Mounting	Mounting holes provided
Materials	Anodized aluminum, stainless steel

The 2020 has an external #10-32 port for the pressure supply to the EV/ET electronic pilot valve. The 2021 has an internal pressure supply to the EV/ET.

2-WAY & 3-WAY AIR PILOT VALVES

PAV/PAVO SERIES

These Normally-Open or Normally-Closed 2-Way and 3-Way valves incorporate an integral pilot actuator that provides a compact assembly and simple installation. The internal valving is identical to the MAV-2/3 or MAVO-2/3.

Medium	Air, water, or oil
Input Pressure	PAV-2/3: 300 psig PAVO-2/3: 150 psig max.
Air Pilot Pressure	15 psig min.
Air Flow	PAV-2/3: 113 l/min @ 50 psig; 190 l/min @ 100 psig PAVO-2/3: 190 l/min @ 50 psig; 330 l/min @ 100 psig
Mounting	5/8-32 thread or #4 screw
Materials	Brass body, nitrile seals, stainless steel stem and spring
Accessories	Foot Bracket: FB-1791 Nut and Lockwasher: PAV-MH

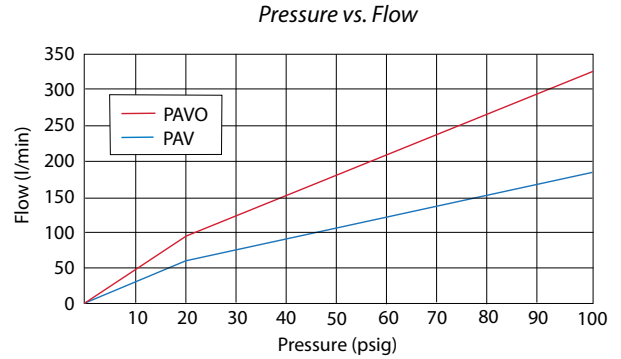

Air pilot valves are ideal for remote and miniature applications which require higher air flow and/or lower power

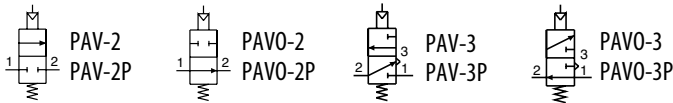

NORMALLY-CLOSED POPPET VALVES

Port(s)	2-Way	3-Way
#10-32 1/8" NPT	PAV-2 PAV-2P	PAV-3 PAV-3P



PAV-2P shown

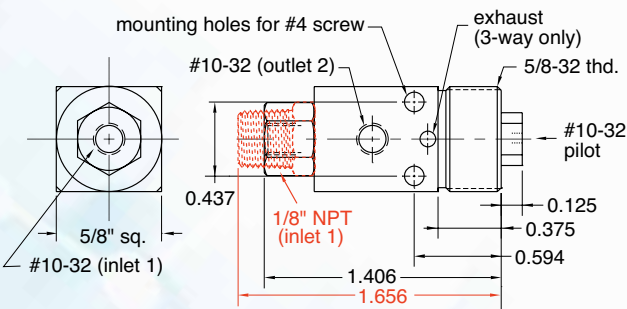

NORMALLY-OPEN SPOOL VALVES

Port(s)	2-Way	3-Way
#10-32 1/8" NPT	PAVO-2 PAVO-2P	PAVO-3 PAVO-3P



PAVO-2 shown

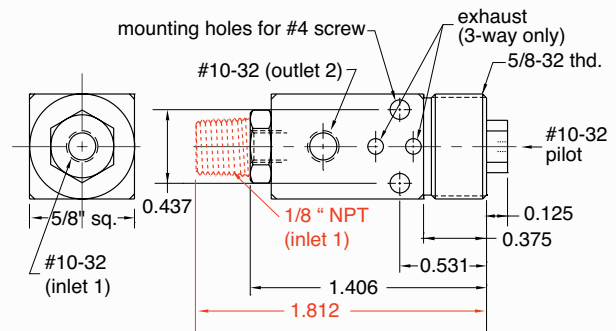

MAXIMATIC® SERIES AIR PILOT VALVES

ORDERING GUIDE



3-WAY VALVES

Series No.	Inlet	Outlet	Exhaust	Ports/Position	Cv	Flow @ 100 psig	Page
MMA-31NAS	#10-32	#10-32	#10-32	3/2	0.58	760 l/min	100
MMA-31PAS	1/8" NPT	1/8" NPT	1/8" NPT	3/2	0.67	880 l/min	100
MMA-32QAS	1/4" NPT	1/4" NPT	1/8" NPT	3/2	0.89	1,400 l/min	100
MMA-33WAS	3/8" NPT	3/8" NPT	1/4" NPT	3/2	1.68	2,600 l/min	100
MMA-34ZAS	1/2" NPT	1/2" NPT	1/2" NPT	3/2	2.79	4,800 l/min	100
MMA-31NAA	#10-32	#10-32	#10-32	3/2	0.58	760 l/min	100
MMA-31PAA	1/8" NPT	1/8" NPT	1/8" NPT	3/2	0.67	880 l/min	100
MMA-32QAA	1/4" NPT	1/4" NPT	1/8" NPT	3/2	0.89	1,400 l/min	100
MMA-33WAA	3/8" NPT	3/8" NPT	1/4" NPT	3/2	1.68	2,600 l/min	100
MMA-34ZAA	1/2" NPT	1/2" NPT	1/2" NPT	3/2	2.79	4,800 l/min	100

4-WAY VALVES

Series No.	Inlet	Outlet	Exhaust	Ports/Position	Cv	Spool Configuration			
						Flow @ 100 psig	Closed Center	Exhaust Center	Pressure Center
MMA-41NAS	#10-32	#10-32	#10-32	5/2	0.58	760 l/min			
MMA-41PAS	1/8" NPT	1/8" NPT	1/8" NPT	5/2	0.67	880 l/min			
MMA-42QAS	1/4" NPT	1/4" NPT	1/8" NPT	5/2	0.89	1,400 l/min			
MMA-43WAS	3/8" NPT	3/8" NPT	1/4" NPT	5/2	1.68	2,600 l/min			
MMA-44ZAS	1/2" NPT	1/2" NPT	1/2" NPT	5/2	2.79	4,800 l/min			
MMA-41NAA	#10-32	#10-32	#10-32	5/2	0.58	760 l/min			
MMA-41PAA	1/8" NPT	1/8" NPT	1/8" NPT	5/2	0.67	880 l/min			
MMA-42QAA	1/4" NPT	1/4" NPT	1/8" NPT	5/2	0.89	1,400 l/min			
MMA-43WAA	3/8" NPT	3/8" NPT	1/4" NPT	5/2	1.68	2,600 l/min			
MMA-44ZAA	1/2" NPT	1/2" NPT	1/2" NPT	5/2	2.79	4,800 l/min			
MMA-41NAAC	#10-32	#10-32	#10-32	5/3	0.50	650 l/min	•		
MMA-41PAAC	1/8" NPT	1/8" NPT	1/8" NPT	5/3	0.50	650 l/min	•		
MMA-42QAAC	1/4" NPT	1/4" NPT	1/8" NPT	5/3	0.89	1,400 l/min	•		
MMA-43WAAC	3/8" NPT	3/8" NPT	1/4" NPT	5/3	1.00	2,000 l/min	•		
MMA-44ZAAC	1/2" NPT	1/2" NPT	1/2" NPT	5/3	1.68	2,600 l/min	•		
MMA-41NAAP	#10-32	#10-32	#10-32	5/3	0.50	650 l/min			•
MMA-41PAAP	1/8" NPT	1/8" NPT	1/8" NPT	5/3	0.50	650 l/min			•
MMA-42QAAP	1/4" NPT	1/4" NPT	1/8" NPT	5/3	0.89	1,400 l/min			•
MMA-43WAAP	3/8" NPT	3/8" NPT	1/4" NPT	5/3	1.00	2,000 l/min			•
MMA-44ZAAP	1/2" NPT	1/2" NPT	1/2" NPT	5/3	1.68	2,600 l/min			•
MMA-41NAAE	#10-32	#10-32	#10-32	5/3	0.50	650 l/min		•	
MMA-41PAAE	1/8" NPT	1/8" NPT	1/8" NPT	5/3	0.50	650 l/min		•	
MMA-42QAAE	1/4" NPT	1/4" NPT	1/8" NPT	5/3	0.89	1,400 l/min		•	
MMA-43WAAE	3/8" NPT	3/8" NPT	1/4" NPT	5/3	1.00	2,000 l/min		•	
MMA-44ZAAE	1/2" NPT	1/2" NPT	1/2" NPT	5/3	1.68	2,600 l/min		•	

Maximatic® is a registered trademark of Clippard Instrument Laboratory, Inc.

MAXIMATIC® SERIES AIR PILOT VALVES

3-WAY & 4-WAY VALVES



Maximatic 3-Way and 4-Way air pilot valves are either double pilot or single pilot, spring return in #10-32 thread to 1/2" NPT port sizes. These air pilot valves have 1/8" NPT pilot ports.

Type	Spool (not bidirectional)
Medium	Air (40 micron filtration) or inert gas
Operating Range	Single Air Pilot: 20 to 125 psig Double Air Pilot: 0 to 125 psig <i>Refer to Minimum Pilot Pressure chart (left)</i>
Pilot Pressure	See chart
Maximum Pressure	125 psig
Mounting	Body Ported, Manifold
Materials	Aluminum, Stainless Steel, Thermoplastic
Seals	Nitrile

MINIMUM PILOT PRESSURE

	Single Pilot		Double Pilot		3-Position	
Operating Pressure (psig)	20	80	20	80	20	80
Pilot Pressure (psig)	20	35	5	8	20**	20**

**30 on MMA-41 Series

2-POSITION 3-WAY SPRING RETURN & AIR PILOT VALVES

Spring Return Valves	Double Air Pilot Valves	Inlet	Outlet	Exhaust	l/min*
MMA-31NAS	MMA-31NAA	#10-32	#10-32	#10-32	760
MMA-31PAS	MMA-31PAA	1/8" NPT	1/8" NPT	1/8" NPT	880
MMA-32QAS	MMA-32QAA	1/4" NPT	1/4" NPT	1/8" NPT	1,400
MMA-33WAS	MMA-33WAA	3/8" NPT	3/8" NPT	1/4" NPT	2,600
MMA-34ZAS	MMA-34ZAA	1/2" NPT	1/2" NPT	1/2" NPT	4,800

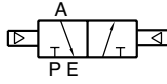

2-POSITION 4-WAY SPRING RETURN & AIR PILOT VALVES

Spring Return Valves	Double Air Pilot Valves	Inlet	Outlet	Exhaust	l/min*
MMA-41NAS	MMA-41NAA	#10-32	#10-32	#10-32	760
MMA-41PAS	MMA-41PAA	1/8" NPT	1/8" NPT	1/8" NPT	880
MMA-42QAS	MMA-42QAA	1/4" NPT	1/4" NPT	1/8" NPT	1,400
MMA-43WAS	MMA-43WAA	3/8" NPT	3/8" NPT	1/4" NPT	2,600
MMA-44ZAS	MMA-44ZAA	1/2" NPT	1/2" NPT	1/2" NPT	4,800

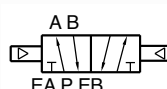
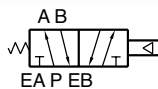

3-POSITION 4-WAY SPRING CENTERED DOUBLE AIR PILOT VALVES

Closed Center, Pressure Center & Exhaust Center



Closed Center	Pressure Center	Exhaust Center	Inlet	Outlet	Exhaust	l/min*
MMA-41NAAC	MMA-41NAAP	MMA-41NAAE	#10-32	#10-32	#10-32	650
MMA-41PAAC	MMA-41PAAP	MMA-41PAAE	1/8" NPT	1/8" NPT	1/8" NPT	650
MMA-42QAAC	MMA-42QAAP	MMA-42QAEE	1/4" NPT	1/4" NPT	1/8" NPT	1,400
MMA-43WAAC	MMA-43WAAP	MMA-43WAAE	3/8" NPT	3/8" NPT	1/4" NPT	2,000
MMA-44ZAAC	MMA-44ZAAP	MMA-44ZAAE	1/2" NPT	1/2" NPT	1/2" NPT	2,600

Conforms to ISO 19973-2 test standards

*Based on flow @ 100 psig

MAXIMATIC® SERIES AIR PILOT VALVE MANIFOLDS

PARALLEL BAR MANIFOLDS & MOUNTING KITS

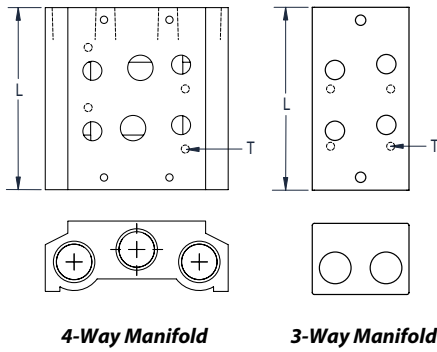

AIR PILOT VALVES

Valve Series	2-Station (L)	4-Station (L)	6-Station (L)	8-Station (L)	16-Station (L)	Thread (T)
MMA-31/41	2.24	3.73	5.25	6.75	12.69	M4
MMA-32/42	2.71	4.50	6.33	8.13	15.38	M4
MMA-33/43	3.22	5.42	7.62	9.82	18.63	M5
MMA-34/44	3.85	6.56	9.38	12.10	23.11	M5

Parallel circuit manifold bars are available for all sizes of MMA 3- and 4-Way valves. Manifolds are made in increments of two stations from two to 16, and are supplied with mounting screws and gaskets. Spare kits are also available which include two screws and a gasket. Blank plate supplied with one gasket, two screws and metal plate.

Valve Series	Manifold Inlet/		2-Station	4-Station	6-Station	8-Station	16-Station
	Exhaust	Blank Plate					
3-Way Valve Manifolds							
MMA-31	1/8"	MMM-31-B	MMM-31-02	MMM-31-04	MMM-31-06	MMM-31-08	MMM-31-16
MMA-32	1/4"	MMM-32-B	MMM-32-02	MMM-32-04	MMM-32-06	MMM-32-08	MMM-32-16
MMA-33	3/8"	MMM-33-B	MMM-33-02	MMM-33-04	MMM-33-06	MMM-33-08	MMM-33-16
MMA-34	1/2"	MMM-34-B	MMM-34-02	MMM-34-04	MMM-34-06	MMM-34-08	MMM-34-16

3-Way Spare Mounting Kit Hardware

27041-31	Hardware Kit for MMA-31 Series Valves	27041-33	Hardware Kit for MMA-33 Series Valves
27041-32	Hardware Kit for MMA-32 Series Valves	27041-34	Hardware Kit for MMA-34 Series Valves

Valve Series	Manifold Inlet/		2-Station	4-Station	6-Station	8-Station	16-Station
	Exhaust	Blank Plate					
4-Way Valve Manifolds							
MMA-41	1/8"	MMM-41-B	MMM-41-02	MMM-41-04	MMM-41-06	MMM-41-08	MMM-41-16
MMA-42	1/4"	MMM-42-B	MMM-42-02	MMM-42-04	MMM-42-06	MMM-42-08	MMM-42-16
MMA-43	3/8"	MMM-43-B	MMM-43-02	MMM-43-04	MMM-43-06	MMM-43-08	MMM-43-16
MMA-44	1/2"	MMM-44-B	MMM-44-02	MMM-44-04	MMM-44-06	MMM-44-08	MMM-44-16

4-Way Spare Mounting Kit Hardware

27041-41	Hardware Kit for MMA-41 Series Valves	27041-43	Hardware Kit for MMA-43 Series Valves
27041-42	Hardware Kit for MMA-42 Series Valves	27041-44	Hardware Kit for MMA-44 Series Valves

MODULAR VALVES

OVERVIEW

Modular valves provide a great deal of versatility with just a few simple components. They consist of essentially three base valve types combined with 18 different options for actuation. As you will see in the proceeding pages, this results in a huge variety of valve options.



BASE VALVE TYPES

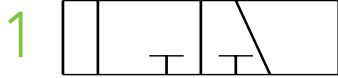

Can be used as:

- 2-Way N.C. or N.O.
- 3-Way N.C. or N.O.
- 3-Way Diverter or Selector



Can be used as:

- 4-Way fully ported
- Dual 2-Way (N.O. and N.C.)
- Dual 3-Way with common exhaust (N.O. and N.C.)



Can be used as:

- 6-Way fully ported
- Dual 2-Way N.C. or N.O.
- Dual 3-Way N.C. or N.O.
- Dual Selector

ACTUATION OPTIONS

Spring Return

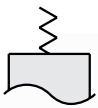

Air Pilot

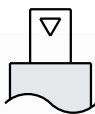

Spring and Auxiliary Pilot



Removable Spring and Auxiliary Pilot

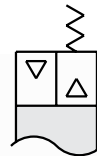

2 Air Pilots "Or"

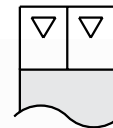

Differential Air Pilots

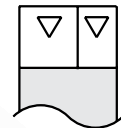

Solenoid Piloted

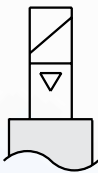

Delay Out from Air Pilot

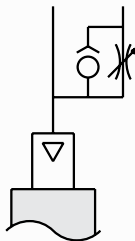

Delay In from Air Pilot

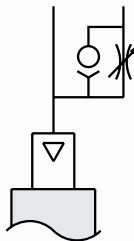

Low Pressure Air Pilot



3 Air Pilots "Or"

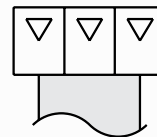

4 Air Pilots "Or"

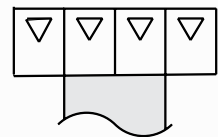

Independent Shuttle Valve and Air Pilot



Shuttle Valve to Air Pilot

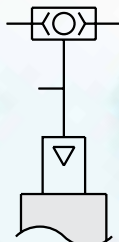

Shuttle Valve to Low Pressure

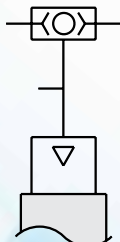

Delay to Air Pilot

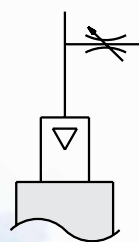

Bleed Pressure Pilot

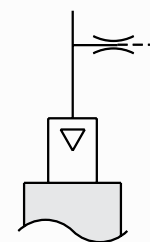

Fluidic Interface Pilot

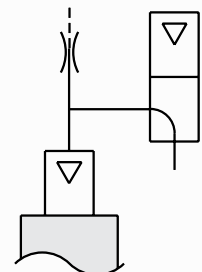

Modular Valves

Versatility is the key when it comes to these supreme "plug-and-play" pneumatic valves. Available in an unlimited variety of directional, low pressure, and special control valves, each is encased in a body designed to mount and link together with a simple piping system.

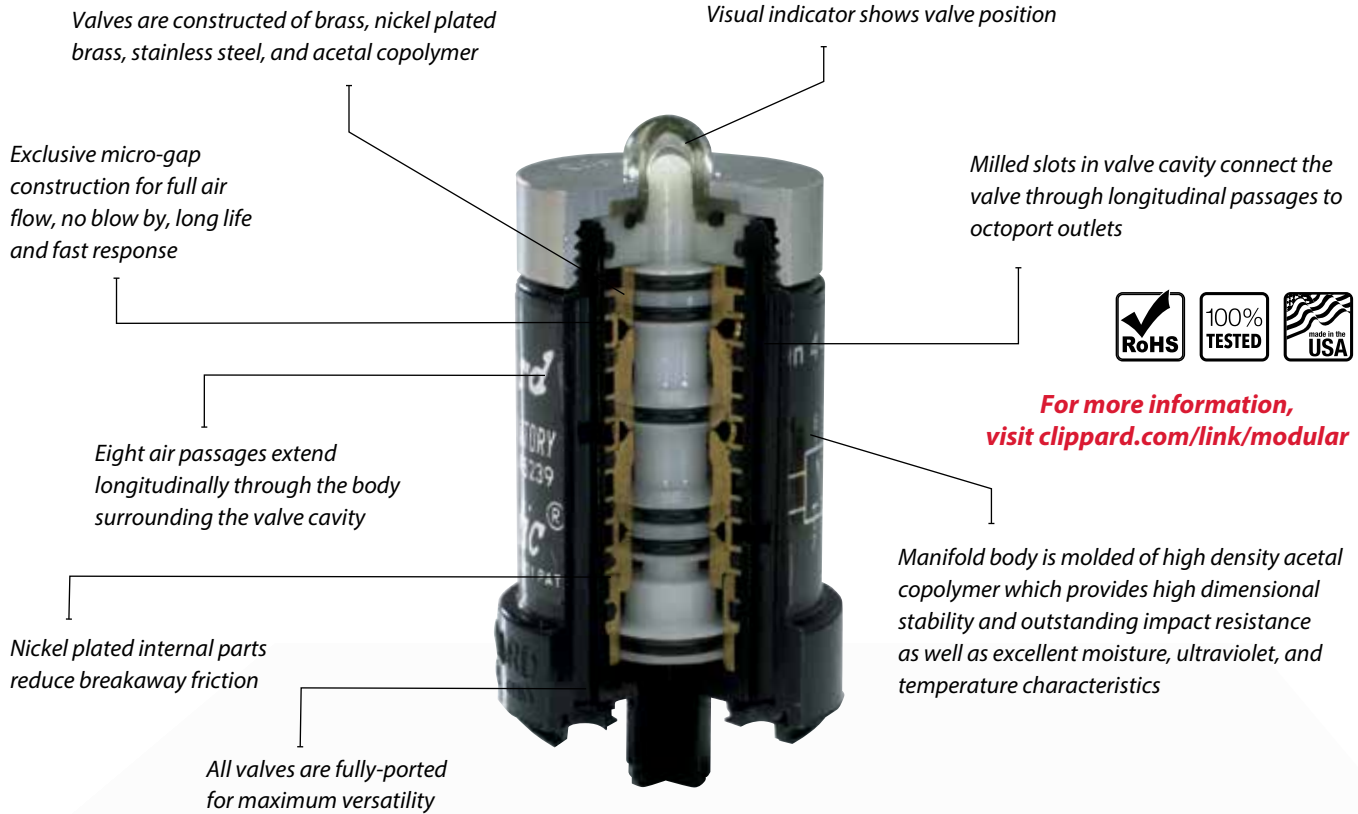

Clippard modular valves can easily be configured to perfectly meet the needs of a wide variety of applications. Call 1-877-245-6247 today to discuss your requirements.

- Air pilot pneumatic valves for air, oil, or water
- Fast response and long life
- Balanced spool design
- Keyed manifold mounting
- Over 70 configurations available
- 0 to 150 psig working pressure
- 250 l/min @ 100 psig flow

OCTOPORT CODING

The coding method shown here is frequently used to identify port usage for different variations of Clippard modular valves. Letters are used to identify the supply or signal (S), the output (O), the exhaust (E), and the pilot input (P).

Many modular valves have multiple ported supplies, outputs, or exhausts. If duplicate ports are indicated, one may be marked with an X to indicate that it needs to be plugged. Both/either of the duplicate ports may be used, but unused duplicate ports must be plugged.

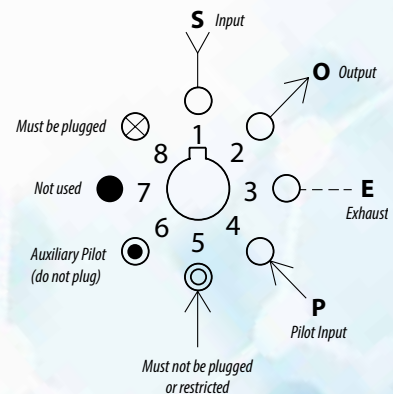

MODULAR VALVES

PNEUMATIC CIRCUIT MODULES

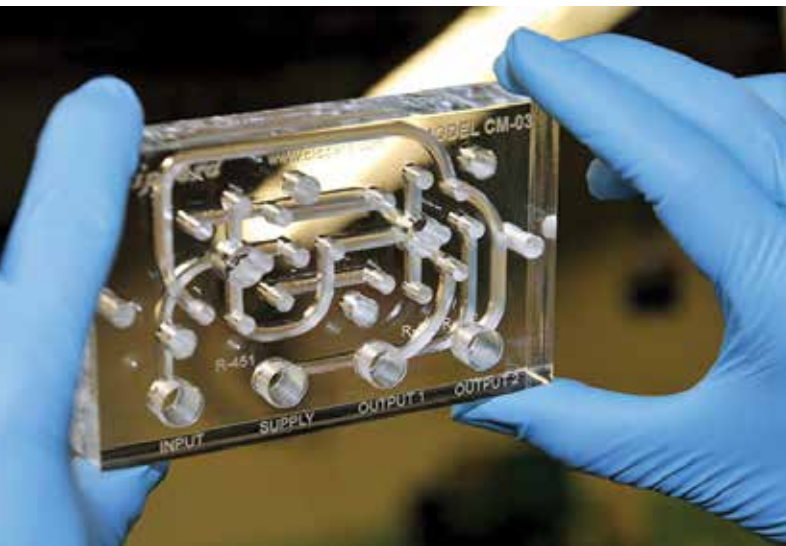

Clippard modular valves are available in an unlimited variety of directional, flow, pressure and special control valves, each in a valve body designed to mount and link together with a simple piping system. This system eases assembly and plumbing, resulting in reduced labor costs, fewer errors in installation, and less potential for plumbing leakage. Multiple valve elements can be contained in a single body, providing incredible flexibility and variety to accomplish a myriad of control challenges. Minimatic® modular valves are the supreme “plug-and-play” devices for pneumatic applications.

Versatility is the key when it comes to Clippard **modular valves**

MOST POPULAR STANDARD CIRCUIT MODELS

- VA-03 Binary Redirect Module (“Flip-Flop Circuit”)
- VA-011 Oscillator Module or Auto-Cycling of a Single-Acting Cylinder
- VA-08 Module for Single Input Clamp Control
- VA-012 Two-Hand, No-Tie-Down (THNTD) Circuit
- VA-034 Add-On Module Provides Back Pressure Latch Control
- VA-038 Two-Hand, No-Tie-Down Circuit with Latching Control
- VA-028 Auto-Cycling of Double-Acting Cylinder, 2 Valves
- VA-06 Auto-Cycling of Double-Acting Cylinder, 3 Valves
- VA-031 Back Pressure Sensing for Double-Acting Cylinder
- VA-033 Back Pressure Sensing with a Double-Acting Cylinder Using External Power Valve

For more information, schematics and drawings, visit clippard.com/link/modular



SPEEDY CIRCUIT ASSEMBLY

You can have a faster, more dependable way to produce multiples of the same pneumatic circuit!

Clippard's modular valve system enables speedy assembly while assuring accurate connections. By utilizing Clippard's unique manufacturing process, these clear acrylic subplates provide sealed passageways between valves without the need for gaskets, clamps, or piping. **It's the fastest, most efficient circuit system available!**

MODULAR VALVES

MOUNTING SUBPLATES & STRIPS



Acrylic subplates provide for up to three modular valves with various port options. Metallic plates mount to standard mounting strips.

Part No.	Valves	Port(s)	Material	Length	Width	Height	Mounting
R-101	1	-	Metallic	1.625"	2.500"	0.375"	#10-32
R-111	1	-	Metallic	1.734"	1.734"	0.437"	#10-32
CM-04	1	#10-32	Acrylic	3.000"	3.000"	0.625"	(2) 0.196" dia.
CM-02	1	1/8" NPT	Acrylic	3.500"	3.000"	0.625"	(2) 0.196" dia.
CM-036	2	1/8" NPT	Acrylic	7.000"	3.000"	0.625"	(4) 0.196" dia.
CM-037	3	1/8" NPT	Acrylic	10.75"	3.000"	0.625"	(4) 0.196" dia.



MOUNTING STRIPS & STANDOFF DIMENSIONS

For providing space beneath assembled group of modules, use R-106 (order R-107-20, packet of four with hardware). Provides 2" clearance from enclosure wall for piping with Clippard fittings and tubing. Keeps piping and installation neat.

R-107-20

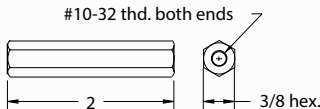

When metallic subplates are mounted to mounting strips, the components build into a strong, rigid assembly. Because of extra tolerance in the holes, note that strips may be adjusted before screws are fully tightened. This permits accurate alignment of subplates. The identifying number following the second dash in the part number indicates the number of modules the strip will accommodate while still proving a

short extension with one hole at both ends in mounting the assembly to stand-offs or other structures. The strip will accommodate one additional

module if no extensions for mounting are needed. (Every two holes will accept a subplate.)

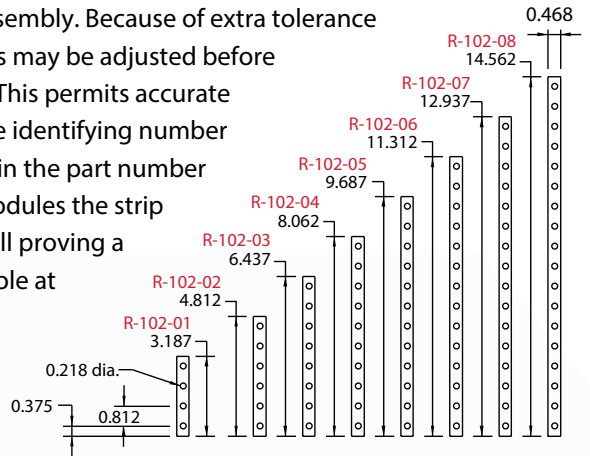

Adding Value is Our Business

Clippard's Integrated Solutions team designed a simple, straight-forward approach for piloting process valves. This assembly greatly simplifies installation and ease-of-use for the OEM design engineer.

Clippard has a unique advantage by providing custom products and value-added assemblies based on the most successful miniature pneumatic line in the world.



Clippard has designed and manufactured thousands of custom manifolds and assemblies based on specific customer requirements.

MODULAR VALVES

STANDARD CIRCUIT MODELS

BINARY REDIRECT MODULE ("Flip-Flip" Circuit)

Input signal alternates outputs A and B, sometimes referred to as a push-on/push-off circuit. The circuit manifold combines the R-451 and R-412 in a binary redirect or flip-flop circuit. Use of the R-412 provides a "memory" function to return the output to known position (port 8 whenever air is first turned on to the circuit. This output pilots port 4 of the R-451, positioning it for the next signal. A signal input passes through the R-451, ports 1 to 2, and pilots port 4 of the R-412. The output of the R-412 shifts to port 2 and also pilots port 6 of the R-451. When the next signal input is received, it passes through the R-451, ports 1 to 8, and pilots port 6 of the R-412, shifting its output back to port 8.

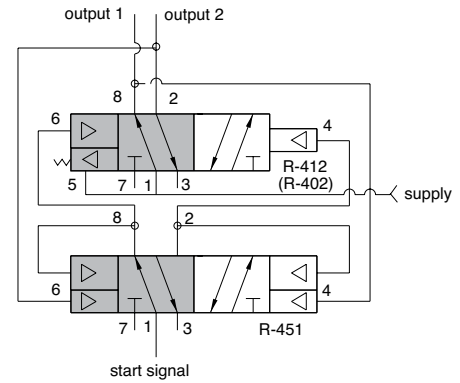

Pressure Range 40 to 150 psig

Part No.	Description
----------	-------------

VA-03 Binary Redirect Module

Circuit includes one R-451 valve, one R-412 valve, one CM-03-PQ circuit manifold, and fittings



Signal Valve
MAV-3 with PC-3
or use a Foot Pedal
or use an Electronic Valve
to create a high flow
Latching 4-way valve

VA-03 Module

Automate Heavy Lids
Automate Doors
Automate Manual Levers
Automate Cable & Pulley Systems
Automate Intrinsically safe Items
Automate Clamps & Collets
Pilot Larger Valves

An Air to Electric Switch may be used on output A while B is blocked
A single input can turn a switch on and off to a light motor, pump, or any other electrical device.

Cylinder

Open / Close
Left / Right
In / Out
Up / Down
On / Off

OSCILLATOR / AUTO-CYCLING MODULE

The VA-011 module is designed to use an "on-off" toggle valve (or alternative input) for an oscillating output that can be used to actuate a single-acting cylinder. With no start input, the cylinder will remain in a retracted position. Turning on the start input signal causes each valve to shift upon the others output signal. The output "on time" can be adjusted for longer or shorter times, and the "off time" is also adjustable.

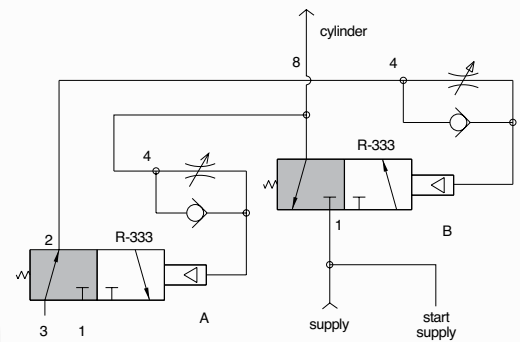

Pressure Range 40 to 150 psig

Part No.	Description
----------	-------------

VA-011 Oscillator or Auto-Cycling Module

Circuit includes two R-333 valves, one CM-011-PQ circuit manifold, fittings, and tubing

MODULAR VALVES

STANDARD CIRCUIT MODELS

MODULE FOR SINGLE INPUT CLAMP CONTROL

Uses a single input (from pneumatic foot pedal or button) to provide a simple and clean “open/close” clamp control with adjustable pressure and speed controls. “Auto-reset” feature ensures when supply is turned on, clamp will always go to the open position.

- Saves time and reduces cost and labor of piping
- Automates product tasks with easy-to-apply unit
- Provides binary push-button operation and built-in speed control
- Pressure regulation included
- May be operated remotely



Circuit includes one R-402 valve, one R-412 valve, one R-451 valve, one R-701 valve, one CM-08-PQ circuit manifold, one MNV-1KP valve, one pressure gauge, one noise muffler, fittings, and tubing.

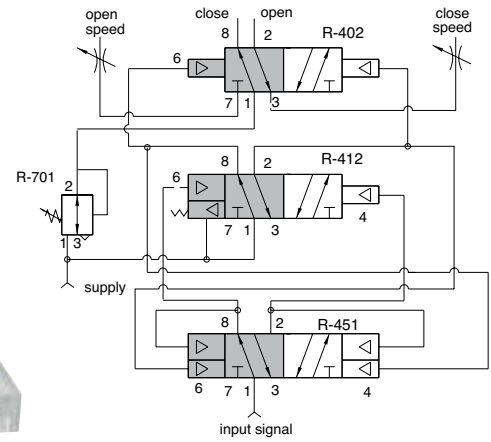

Pressure Range 40 to 150 psig

Part No.	Description
VA-08	Module Only
VA-08-FP	Module with Foot Pedal Actuator
VA-08-GN	Module with Green Palm Button

AUTO-CYCLING OF A DOUBLE-ACTING CYLINDER



Circuit includes one R-333 valve, one R-453 valve, one TV-3S valve, one CM-028-PQ circuit manifold, fitting adapter, fittings and tubing

Similar to the VA-06, this is a more compact version designed for automatic cycling of double-acting cylinders without the use of limit valves or a magnetic sensor. This circuit enables a double-acting cylinder to reciprocate without the use of limit valves and to control its speed in each direction. The two R-333 and R-453 valves also incorporate adjustable delay features that will control the time between retract and extend cycles.

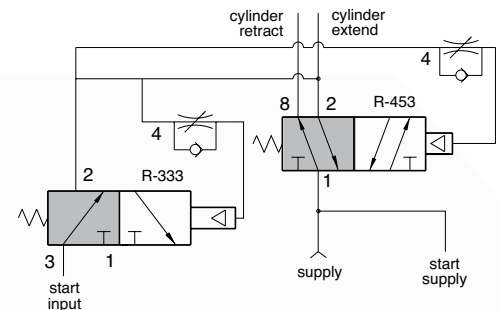

Pressure Range 40 to 150 psig

Part No.	Description
VA-028	Auto-Cycling Module

BACK-PRESSURE SENSING FOR DOUBLE-ACTING CYLINDER



Circuit includes one R-333 valve, one R-453 valve, one TV-3S valve, one CM-028-PQ circuit manifold, fitting adapter, fittings, and tubing

Very versatile for controlling a double-acting cylinder without limits. The circuit uses back pressure to send a signal when the cylinder finishes moving. This module is ideal for integrating into a larger circuit with electronic valves or all pneumatic components.

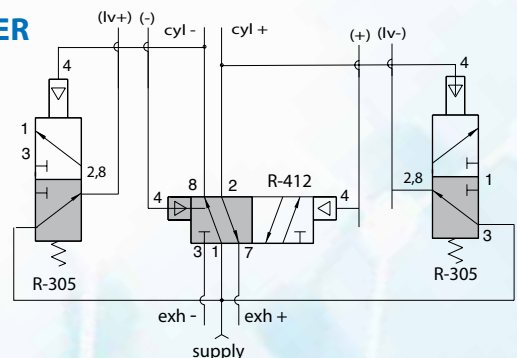

Pressure Range 40 to 150 psig

Part No.	Description
VA-031	Back Pressure Sensing Module

MODULAR VALVES

STANDARD CIRCUIT MODELS

TWO-HAND, NO-TIE-DOWN (THNTD) CIRCUIT

This module is a self-contained circuit board with all interconnections required to provide a Two-Hand, No-Tie-Down (THNTD) pneumatic circuit. The main function of this control is to require a machine operator to use both hands at the same time to actuate the equipment, helping to insure that the operator's hands are not in a position to be injured by the machine as it is in motion.

Enables simple, rapid installation of a pneumatic Two-Hand, No-Tie-Down pneumatic circuit

For more information, visit clippard.com/link/thntd

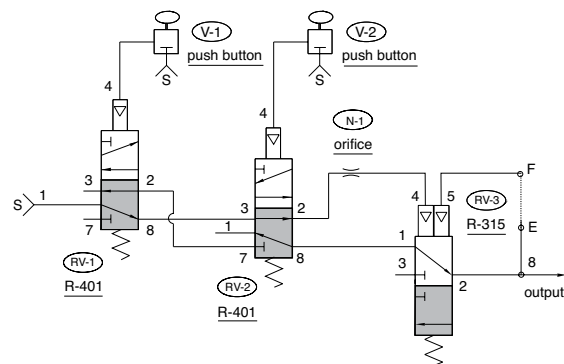

Absolutely no alterations or modifications should be made to this circuit or its components parts.

Pressure Range 50 to 120 psig

Part No.	Description
VA-023	THNTD Circuit, No Palm Buttons
VA-023-GN	THNTD Circuit with 2 Green Palm Buttons
VA-023-RD	THNTD Circuit with 2 Red Palm Buttons

Circuit includes one R-315 valve, two R-401 valves, one CM-023-PQ circuit manifold, fittings, and tubing



RV-3 is held open by supply air that passes through RV-1, RV-2 and N-1. When RV-1 is actuated alone, the pilot air for RV-3 flows back through the N-1 and RV-2 to atmosphere at RV-1, and RV-3 is closed by the spring. When RV-2 is actuated alone, the same sequence occurs except the pilot air from RV-3 exhausts to atmosphere via RV-2.

Restriction N-1 determines the time span during which both signals must be received in order to obtain the output. When RV-1 and RV-2 are actuated together, supply air is directed through RV-1, RV-2 and RV-3 to the output, providing a momentary output signal that is determined by N-1. If a maintained signal is required, a jumper between E and F maintains an output as long as the operator is depressing both palm buttons.

The indicator on RV-3 (R-315) must be down for an output to be obtained. If either RV-1 or RV-2 is actuated separately, their respective indicator will go up, but after approximately one second, the indicator on RV-3 (R-315) will go down showing that the valve has shifted and an output cannot be obtained. Circuit performance and sequence should be periodically observed to verify proper function.

LIMITED WARRANTY

When properly used, this equipment meets ANSI B11.1-1971 and OSHA 1910.217 safety standards for Two-Hand, No-Tie-Down controls. It is the buyer's sole responsibility to determine proper application, location installation, use and maintenance of this equipment. This equipment performs the function of a Two-Hand, No-Tie-Down control only. All other prescribed safety devices must be used with this equipment. Seller shall not be responsible for any failure to so comply which results from the application, installation, location, operation, use or maintenance of this equipment or from alteration of the equipment by persons other than the seller, or from design or instruction furnished by the buyer or his agents.

Sellers liability shall be limited to replacement or modification of the equipment to comply with OSHA standards or to refund the purchase price. Seller will be responsible for any fines, penalties or consequential damage. Clippard makes no other warranty of any kind, expressed or implied.

MODULAR VALVES

STANDARD CIRCUIT MODELS

BACK PRESSURE LATCH CONTROL

The VA-034 module is for operation of a clamp or collet system where Two-Hand, No-Tie-Down (THNTD) input is required to be held continuously until the position desired (limit valve) is fully engaged. THNTD circuit is re-engaged to release the clamp mechanism.

Output of the CM-023 or VA-023 goes to the VA-034 module and begins to extend cylinder. The two palm buttons on the THNTD must remain actuated until the limit valve is actuated or unit will retract the cylinder. When the cylinder has depressed the limit valve, the unit locks the valve, and the cylinder continues to see pressure on the extend port. The unit is latched and buttons can now be released. A second input from the CM-023 or VA-023 (depressing both buttons) will now release the latch and retract the cylinder to the starting position as shown, and the circuit is ready for another operation.

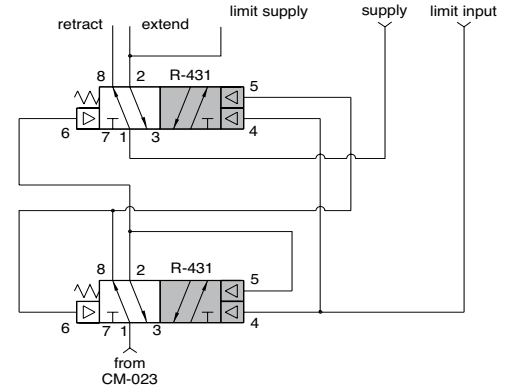

Pressure Range 40 to 150 psig

Part No.	Description
VA-034	Back Pressure Latch Control for VA-023

Circuit includes two R-431 valves, one CM-034-PQ circuit manifold, fittings, and tubing

TWO-HAND, NO-TIE-DOWN CIRCUIT WITH LATCHING CONTROL

The VA-038 module is for operation of a clamp or cylinder operation where Two-Hand, No-Tie-Down (THNTD) input is required to be held continuously until the position desired (limit valve) is fully engaged. The THNTD circuit releases the latch and returns the cylinder to the retracted position.

The two palm buttons on the THNTD must remain actuated until the limit valve is actuated, or the unit will retract the cylinder. When the cylinder has depressed the limit valve, the unit locks the valve, and the cylinder continues to see pressure on the extend port. The unit is latched, and buttons can now be released. A second input from depressing both buttons will now release the latch and retract the cylinder to the starting position as shown, and the circuit is ready for another operation.



Pressure Range 40 to 150 psig

Part No.	Description
VA-038	Module Only, No Palm Buttons
VA-038-GN	Module with 2 Green Palm Buttons
VA-038-RD	Module with 2 Red Palm Buttons

Circuit includes two R-431 valves, two R-401 valves, one R-315 Valve, one CM-038-PQ circuit manifold, two palm buttons (as ordered), fittings, and tubing

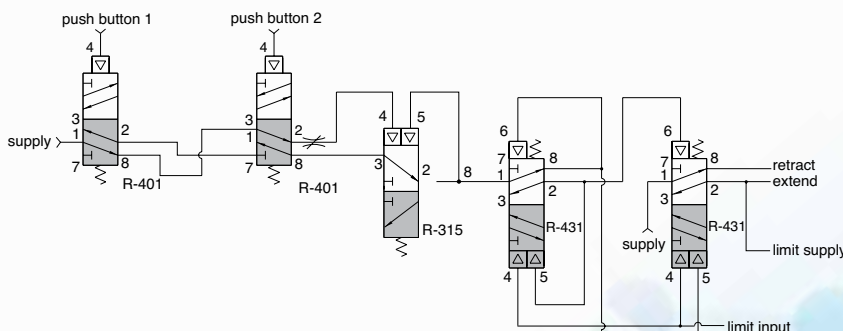

MODULAR VALVES

STANDARD CIRCUIT MODELS

AUTO-CYCLING OF A DOUBLE-ACTING CYLINDER

The VA-06 module is designed to use an “on-off” toggle valve (or alternative input) for the cycling of a double-acting cylinder without the use of limit valves.

This circuit enables a double-acting cylinder to reciprocate without the use of limit valves and to control its speed in each direction. The two R-343 valves also incorporate adjustable delay features that will control the time between retract and extend cycles. With the miniature needle valves, the speed of the cylinder is also adjustable for your application.

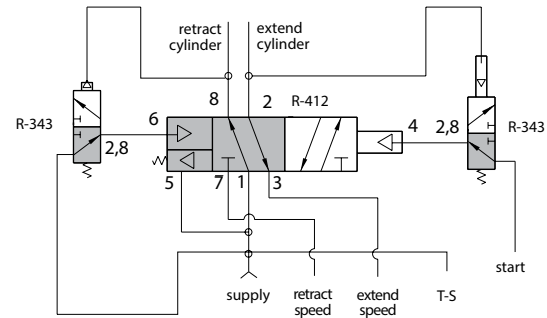

Pressure Range 40 to 150 psig

Part No.	Description
VA-06	Auto-Cycling Module

Circuit includes two R-343 valves, one R-412 valve, one TV-3S valve, one MNV-1KP valve, one CM-06-PQ circuit manifold, mufflers, adapter, fittings, and tubing

BACK PRESSURE SENSING WITH A DOUBLE-ACTING CYLINDER USING EXTERNAL POWER VALVE

The VA-033 module is very similar to the VA-031 for controlling a double-acting cylinder without limits. The circuit uses back pressure to send a signal when the cylinder finishes moving. This module is designed to be used in conjunction with an external power valve.

This circuit enables feedback from the external valve outputs to signal back to the module ports (CYL+ and -) when back pressure is building. Utilizing ports TS and FS allows you to loop them back to the module’s inputs, and create an auto-cycling circuit using back pressure, as opposed to a timing signal (such as the VA-06 module). You can also choose to use the output to go to a manual button, pneumatic delay valve, electronic valve and PLC, or pneumatic sequencer (such as a R-932 circuit) and allow those options to signal back to the module to begin the next cycle.

For assistance with selecting or configuring Clippard pneumatic circuit modules for your application, call **877-245-6247**.

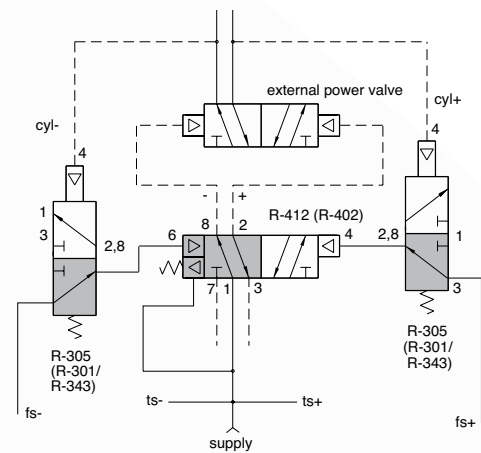

Pressure Range 40 to 150 psig

Part No.	Description
VA-033	Back Pressure Module

Circuit includes two R-305 valves, one R-412 valve, one CM-033-PQ circuit manifold, fittings, and tubing

MODULAR VALVES

3-WAY PILOT VALVES

Normally-Closed, Normally-Open, Selector, Diverter

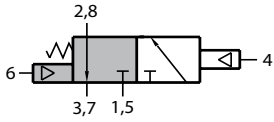

Normally-Closed shown

R-301

3-Way spring return, fully-ported

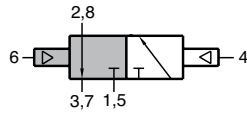

Normally-Closed shown

R-302

3-Way double pilot, fully-ported

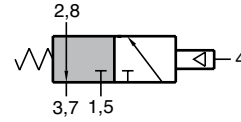

Normally-Closed shown

R-305

3-Way, spring return, fully-ported with low pressure pilot

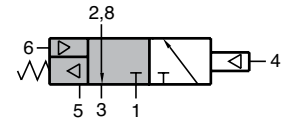

Normally-Closed shown

R-310

3-Way, fully-ported with special spring reset to return to preset position when pressure is lost

3-WAY PILOT VALVES

Normally-Closed, Normally-Open, Selector, Diverter

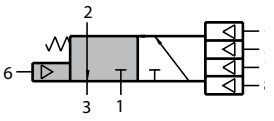

Normally-Closed shown

R-311

3-Way spring return, fully-ported with 4 pilots; any will actuate valve

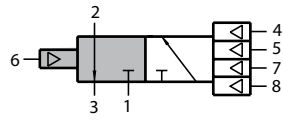

Normally-Closed shown

R-312

3-Way fully-ported with 1 pilot on side and 4 pilots on opposite side; any will actuate valve

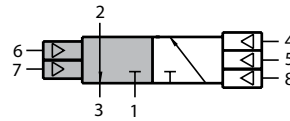

Normally-Closed shown

R-314

3-Way, fully-ported with 2 pilots on side and 3 pilots on opposite side; any will actuate valve

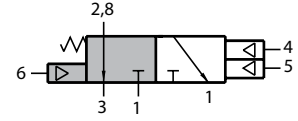

Normally-Closed shown

R-315

3-Way, spring return, fully-ported with 2 pilots, either will actuate valve, and aux. pilot on spring side

3-WAY COMBINATION VALVES

Normally-Closed, Normally-Open, Selector, Diverter

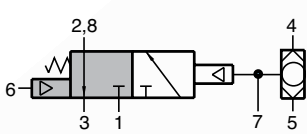

Normally-Closed shown

R-321

3-Way spring return, fully-ported with shuttle valve on the pilot

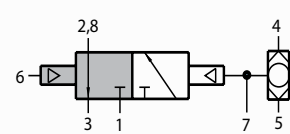

Normally-Closed shown

R-322

3-Way fully-ported with shuttle valve on 1 sides pilot

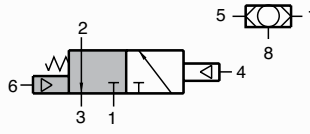

Normally-Closed shown

R-323

3-Way, spring return, fully-ported with independent shuttle valve in the same body

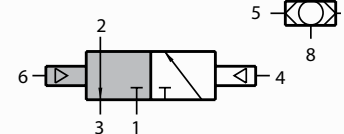

Normally-Closed shown

R-324

3-Way fully-ported with independent shuttle valve in body

3-WAY 2-POSITION AIR PILOT DELAY VALVES

Normally-Closed, Normally-Open, Selector, Diverter

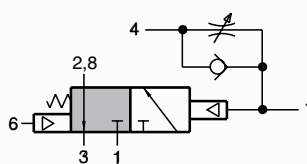

R-331/333

Delay "In" function will allow a signal at port 4 to delay through an adjustable flow control and delay the actuation of the valve

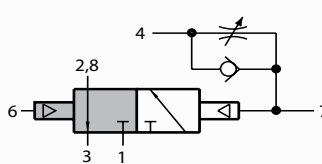

R-332/334

Delay "In" function will allow a signal at port 4 to delay through an adjustable flow control and delay the actuation of the valve. Pressure at port 6 will shift the valve back

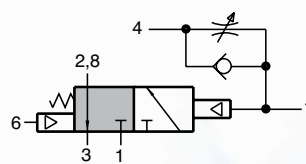

R-341/343

Delay out function will allow a signal at port 4 to shift the valve immediately. Loss of air at port 4 will delay the valve to shift to its original position



MODULAR VALVES

3-WAY SPECIALTY VALVES

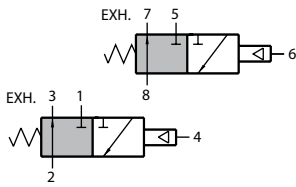

Normally-Closed Double

R-351

Combination of two independent 3-Way, Normally-Closed, 2-position spring return valves

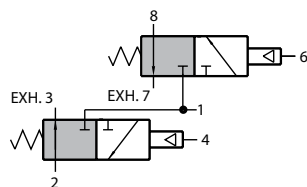

Normally-Closed Double with Common Supply

R-352

Combination of two independent 3-Way, Normally-Closed, 2-position, spring return valves with a common supply port for convenience

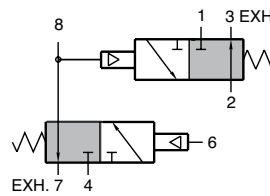

Normally-Closed Double "AND" Valve

R-353

Combination of two 3-Way, Normally-Closed, 2-position spring return valves that make up a 3-input "AND" subcircuit

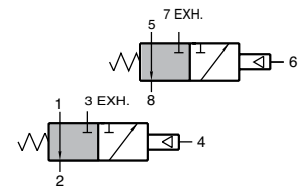

Normally-Open Double

R-355

Combination of two independent 3-Way, Normally-Open, 2-position spring return valves

4-WAY SINGLE PILOT VALVES

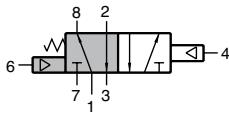

R-401/R-402

4-Way, fully-ported, 2-position. R-401 is a spring return valve

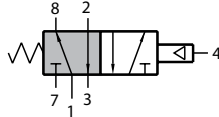

R-405

4-Way, spring return, fully-ported with low pressure pilot

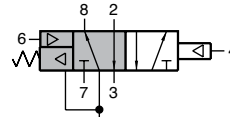

Reset

R-412

4-Way fully-ported, 2-position double air-pilot valve with a return to home when supply air is exhausted

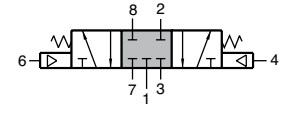

3-Position

R-421

4-Way fully-ported 3-position spring to center valve

4-WAY MULTI-PILOT VALVES

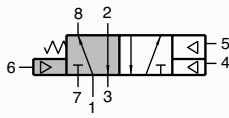

R-431

5-ported, 4-Way spring return, dual pilot. Indicator shows valve in shaded position.

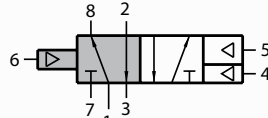

R-432

5-ported, 4-Way dual pilot. Indicator shows valve in shaded position.

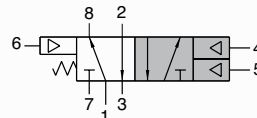

R-433

5-ported, 4-Way spring return, dual pilot. Indicator shows valve in shaded position.

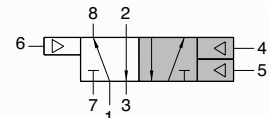

R-434

5-ported, 4-Way dual pilot. Indicator shows valve in shaded position.

4-WAY DELAY PILOT VALVES

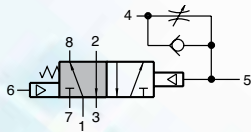

R-443

4-Way spring return, fully-ported with adjustable flow control. Metered "Out" on pilot

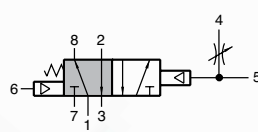

R-445

4-Way spring return, fully-ported with adjustable needle valve connected to pilot

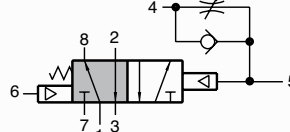

R-453

4-Way spring return, fully-ported with adjustable flow control. Metered "In" on pilot

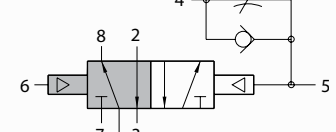

R-454

4-Way fully-ported with adjustable flow control. Metered "In" on pilot

MODULAR VALVES

4-WAY SPECIALTY VALVES

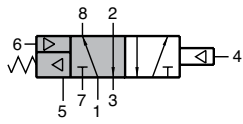

R-410

4-Way, fully-ported with special spring reset to return to preset position when pressure is lost

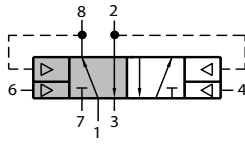

R-451

4-Way for use with R-402/R-412 in "Flip-Flop" circuit

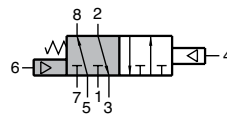

R-461

4-Way spring return, 6-ported

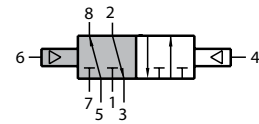

R-462

4-Way, 6-ported

4-WAY SPECIALTY VALVES

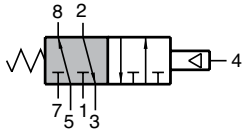

R-465

4-Way spring return, 6-ported with low pressure pilot

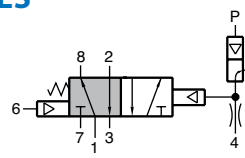

R-471

4-Way spring return, fully-ported with amplified pilot

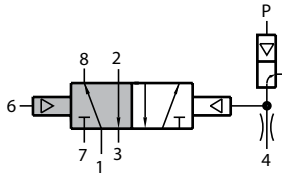

R-472

4-Way fully-ported with amplified pilot

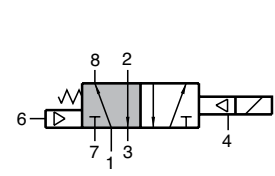

R-481

4-Way spring return, fully-ported, piloted by Clippard ET-3 valve

SPECIALTY VALVES

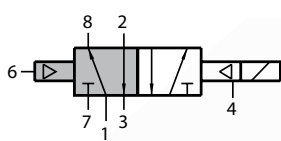

R-482

4-Way, fully-ported, piloted by Clippard ET-3 electronic valve

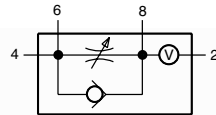

R-501 (shown)/502

Flow control valves. R-501, Delay in, R-502, Delay out

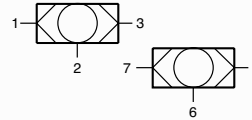

R-602 (shown)/603

Dual shuttle valves. R-603, 3 input "OR"

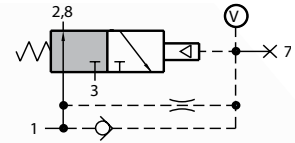

R-711

Pulse valve, Normally-Open

SEQUENCE VALVE

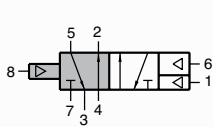

R-932

Sequence valve

4-WAY BLEED PILOT

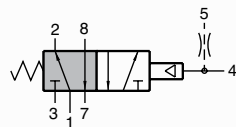

R-441

4-Way spring return, fully-ported with bleed pilot for low force sensors

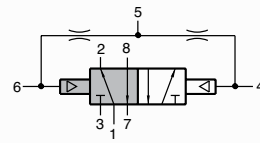

R-442

4-Way, fully-ported with bleed pilots for low force sensors

SUBPLATE CONNECTOR



R-811

Connector to subplate R-101, R-111 and manifolds

FILTER MODULE

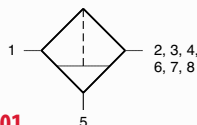

R-801

Filter Module, 25 micron

VOLUME CHAMBER

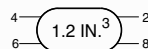

R-821

Volume Chamber, 1.2 cubic inch

Control Valves



CHECK VALVES

- Allow flow in one direction and automatically prevent flow in the opposite direction
- Durable brass body construction
- Variety of porting options

p. 116



EXHAUST VALVES

- Compact, durable brass construction
- #10-32, 1/8" NPT and 1/4" NPT

p. 117



IN-LINE AIR CHOKES & VOLUME CHAMBERS

- Provides time delay
- Durable brass bodies

p. 121



MUFFLERS

- Recommended for controlling noise or speed
- Durable brass bodies with porous sintered bronze air mesh

p. 121



SHUTTLE VALVES

- Allow flow from one inlet to outlet while blocking the other inlet
- #10-32, 1/8" NPT and 1/4" NPT

p. 127



PULSE VALVE

- Available in #10-32, 1/8" NPT, or modular versions
- Widely used in control circuits

p. 128



FLOW CONTROLS

- Available in 4 styles
- Ideal for use with pneumatic cylinders
- Also used with air pilot valves for delay functions

pp. 118-120



GAUGES

- Display two pressure ranges
- Built-in pressure snubber
- Constructed with a steel case and plastic face

p. 121



NEEDLE VALVES

- Used to control the rate of flow in both directions
- Various port and needle configurations available
- Provide coarse or fine adjustment

pp. 122-123



PRESSURE REGULATORS

- Offered in either relieving or non-relieving versions
- Variety of adjustment options and mounting styles

pp. 124-126



SENSORS & AIR INDICATORS

- Non-contact proximity sensors
- Differential pressure sensors
- Whisker valves
- Single- and multi-pin air indicators

p. 128



SWITCHES

- Manual and pneumatic
- Convert air pressure to an electrical signal

p. 129

Many items also available with metric ports.
For more information, visit clippard.com/link/metric

CHECK VALVES

MCV, GCV & JPC SERIES



Multiple varieties of check valves permit flow in one direction only. Valve bodies provide in-line mounting, nitrile seals, and stainless steel springs (standard). The MCV-2 has a “duckbill” seal, the MCV-1 series has a brass poppet, and the MJC series has a Zytel 80G33 poppet.

Medium Air
Mount Direct or in-line
Temp. Range 32 to 230°F

*Not intended for pressure relief
 Arrow on valve indicates direction of flow*

	Part No.	Inlet	Outlet	Flow @ 50/100 psig	Input Pressure	Pressure to Crack
	MCV-1	#10-32M	#10-32F	6.5/325 l/min	300 psig	1/2 psig
	MCV-1AA	#10-32M	#10-32M			
	MCV-1AB	#10-32F	#10-32M			
	MCV-1BB	#10-32F	#10-32F			
	MCV-2	#10-32F	#10-32F	28 l/min @ 50 psig	100 psig	1 psig
	MJC series	1/8" NPTF	1/8" NPTF	20/1,000 l/min	300 psig (1,000 psig hydraulic max.)	1/2 psig
	MJC-1AA	1/8" NPTM	1/8" NPTM			
	MJC-1AB	1/8" NPTF	1/8" NPTM			
	MJC-1BA	1/8" NPTM	1/8" NPTF			
	GCV-4	1/4" NPTF	1/4" NPTF			
GCV-5	1/4" NPTF	1/4" NPTF	84/4,200 l/min			

PILOT-OPERATED CHECK VALVES

Pilot-operated check valves work as standard check valves but can be opened with an air pilot signal to permit free flow in the normally “checked” direction. This provides the user with a reliable method to check flow in one direction with the ability to remotely signal a free flow through the valve. Clippard's JPC series all-in-one pilot-operated check valves are easy to connect and ideal for any circuit that might benefit from this useful function.

Medium Air, water, or oil **Mount** Direct
Temp. Range 32 to 230°F **Material** ENP brass, anodized aluminum, stainless steel, nitrile seals

	Part No.	Cyl. Port	Side Port	Pilot Port
	JPC-2NLN	#10-32 M	#10-32 F	#10-32 F
	JPC-2NPN	1/8" NPT	#10-32 F	#10-32 F
	JPC-3FPN	1/8" NPT	1/8" NPT	#10-32 F
	JPC-3FPF	1/8" NPT	1/8" NPT	1/8" NPT
	JPC-3FQF	1/4" NPT	1/8" NPT	1/8" NPT

- High flow valve means low pressure drop
- Uses Clippard's superior poppet design
- #10-32 auxiliary port allows ease of plumbing
- Side port (port 2) rotates for ease of positioning
- Pressure range up to 300 psig (see charts below)

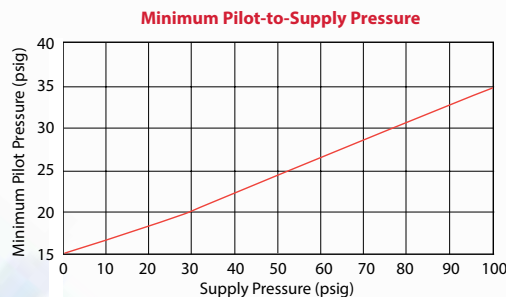
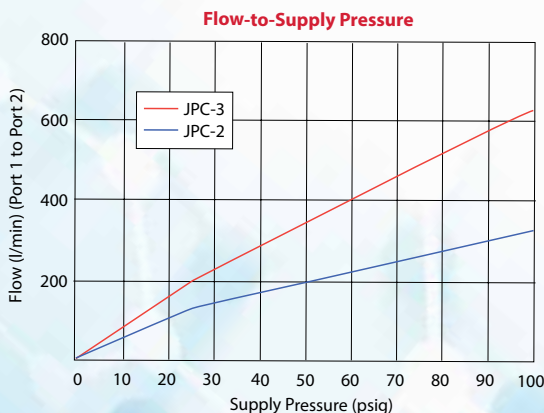

Contact Clippard for pilot-to-supply pressures above 100 psig

EXHAUST VALVES

MEV, JEV & JLEV SERIES



Clippard's exhaust valves provide fast response times and high flow with #10-32, 1/8" and 1/4" NPT ports. These compact, poppet type valves feature a durable brass construction and are 100% tested to assure the highest quality. Their primary function is to increase cylinder speed. However, Clippard's exhaust valves also enable the use of smaller directional valves, allow for longer control lines, and may be used as a shuttle valve.

Medium Air
Material Brass body, nitrile poppet
Working Range 15 to 150 psig
Mounting Direct to cylinder



- Enables use of smaller control valves
- 15 to 150 psig maximum
- Male outlet offers direct connection to cylinder
- Low shift ratio
- Custom configurations also available
- Brass construction with molded nitrile seal

CONTROL VALVES

	Part No.	Inlet	Outlet (Cyl.)	Exhaust	Air Flow (Exhaust)
	MEV-2	#10-32F	#10-32M	#10-32F	140 l/min @ 50 psig; 250 l/min @ 100 psig
	JEV-F2F2	1/8" NPTF	1/8" NPTF	1/8" NPTF	1,000 l/min @ 50 psig; 1,600 l/min @ 100 psig
	JEV-F2M2	1/8" NPTF	1/8" NPTM	1/8" NPTF	
	JEV-F2M4	1/8" NPTF	1/4" NPTM	1/8" NPTF	
	JEV-F4M4	1/4" NPTF	1/4" NPTM	1/8" NPTF	
	JEV-F4F4	1/4" NPTF	1/4" NPTM	1/8" NPTF	
	JLEV-F2M2-N	1/8" NPTF	1/8" NPTM	thru holes	
	JLEV-F4M4-N	1/4" NPTF	1/4" NPTM	thru holes	

In a typical application, the exhaust valve is installed in the inlet of a spring return or double-acting pneumatic cylinder. Supply air from a control valve is directed into the inlet port of the exhaust valve. The nitrile poppet seals the exhaust port and allows air to flow from the outlet port of the valve into the cylinder. The pressurized air pushes against the piston and extends the rod, compressing the spring, until full rod extension is achieved.

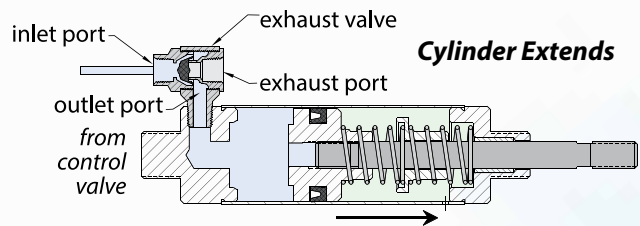

When the control valve exhausts, air from the exhaust valve inlet port, the nitrile poppet shifts to seal the inlet port and open the exhaust port to the cylinder. The pressurized air is allowed to exhaust directly through the exhaust valve to atmosphere.

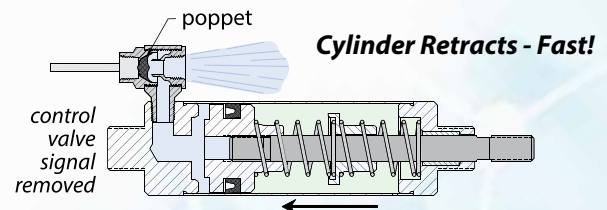

Normally the air must travel back through the long airline to the control valve to exhaust. By mounting the exhaust valve directly on the cylinder, the piston retracts quickly since the distance to atmosphere is very short and unrestricted.

FLOW CONTROLS

JFC & MFC SERIES



Clippard offers five models of adjustable flow controls with #10-32 through 3/8" NPT ports with many connection and adjustment options. They feature a combination needle and check valve that controls flow in one direction and allows free flow in the opposite direction. They are an ideal valve for use with a cylinder, providing a slow extend stroke while allowing a fast retract stroke. The chart illustrates the flow versus the number of needle adjustments turns.

- Materials** Aluminum, anodized aluminum, or brass body; nitrile seals
- Input Pressure** 150 psig max. (MFC-2: 300 psig)
- Pressure To Open** Cracks at approx. 2 psig
- Mounting** Direct (MFC-2: in-line)



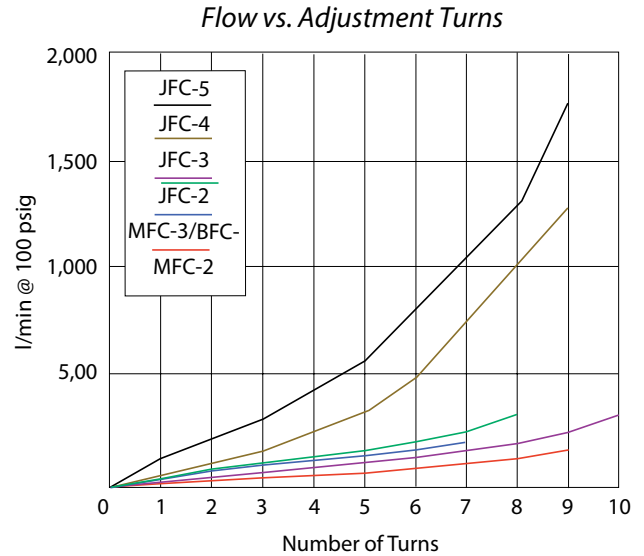



Special configurations are available.
Call for further information.

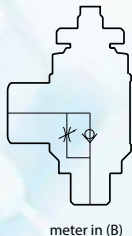

Part No.	Port	Adjustment
#10-32F Thread, 200 l/min @ 100 psig		
 Brass MFC-2	#10-32F	Knurled Knob
 <i>Meter In</i> ENP brass and anodized aluminum MFC-3A MFC-3AK MFC-3AR <i>MFC-3AK shown</i>	#10-32	Screwdriver Slot Knurled Knob Recessed Needle
 <i>Meter Out</i> ENP brass and anodized aluminum MFC-3B MFC-3BK MFC-3BR <i>MFC-3B shown</i>	#10-32	Screwdriver Slot Knurled Knob Recessed Needle



Part No.	Port	Adjustment
1/8" NPTM Thread, 310 l/min @ 100 psig		
 <i>Meter Out</i> ENP brass JFC-2A JFC-3A JFC-3AR <i>JFC-2A shown</i>	1/8" NPT	Knurled Knob Knurled Knob Recessed Needle
 <i>Meter In</i> ENP brass JFC-2B JFC-3B JFC-3BR	1/8" NPT	Knurled Knob Knurled Knob Recessed Needle
1/4" NPTM Thread, 1250 l/min @ 100 psig		
 <i>Meter Out</i> Anodized Aluminum JFC-4K JFC-4R <i>JFC-4K shown</i>	1/4" NPT	Knurled Knob Recessed Needle
3/8" NPTM Thread, 1700 l/min @ 100 psig		
 <i>Meter Out</i> Anodized Aluminum JFC-5K JFC-5R <i>JFC-5K shown</i>	3/8" NPT	Knurled Knob Recessed Needle

FLOW CONTROLS

PQ SERIES



PQ-CV & PQ-CI

PQ-FV

RIGHT ANGLE METER-OUT CONTROLS

Part No.	Tubing Size	Thread
PQ-CV04N	1/8"	#10-32
PQ-CV04P	1/8"	1/8" NPT
PQ-CV05N	5/32"	#10-32
PQ-CV05P	5/32"	1/8" NPT
PQ-CV08N	1/4"	#10-32
PQ-CV08P	1/4"	1/8" NPT
PQ-CV08Q	1/4"	1/4" NPT
PQ-CV12Q	3/8"	1/4" NPT
PQ-CV12W	3/8"	3/8" NPT
PQ-CV16Q	1/2"	3/8" NPT

RIGHT ANGLE METER-IN CONTROLS

Part No.	Tubing Size	Thread
PQ-CI04N	1/8"	#10-32
PQ-CI04P	1/8"	1/8" NPT
PQ-CI05N	5/32"	#10-32
PQ-CI05P	5/32"	1/8" NPT
PQ-CI08N	1/4"	#10-32
PQ-CI08P	1/4"	1/8" NPT
PQ-CI12Q	3/8"	1/4" NPT
PQ-CI12W	3/8"	3/8" NPT
PQ-CI16W	1/2"	3/8" NPT

IN-LINE CONTROLS

Part No.	Tubing Size	Dia.
PQ-FV04	1/8"	0.125
PQ-FV05	5/32"	0.125
PQ-FV06M	6 mm	0.170
PQ-FV08	1/4"	0.170
PQ-FV08M	8 mm	0.170
PQ-FV12	3/8"	0.170
PQ-FV16	1/2"	0.170

PQ-FV in-line flow controls can be easily added to existing circuitry and are lightweight and compact in size. Since it is a tube-to-tube connection, in-line flow controls may be installed as a meter-in or meter-out device.

Clippard PQ-C elbow controls are ideal for low cost and lightweight applications which require mounting directly to an NPT port on a cylinder or valve.

In the meter-out versions, intake air flows freely through the flow control; exhaust air is metered out through an adjustment screw. With the meter-in series, air is metered in through an adjustment screw; exhaust air flows freely. Control is varied through a finely threaded adjustment screw. A locking nut is provided so it can be secured in its final setting.

Medium	Air
Input Pressure	0 to 150 psig
Vacuum	0 to 29.5" Hg
Ports	#10-32, 1/8" NPT, 1/4" NPT, 3/8" NPT, 1/2" NPT
Adjustment	Knurled knob
Material	Nickel plated brass, plastic resin, stainless steel gripper ring, nitrile seals

- Small, compact size
- Design flexibility and fast response
- Complete rotation of the valve body around the body allows for optimum positioning of tubing
- Special adjustment needle design allows large adjustment ranges with high precision
- Ideal for use with polyurethane, nylon, polyethylene, and polypropylene tubing

FLOW CONTROLS

BFC, BNV & BNM SERIES

Clippard's block flow control and needle valves have a variety of features that offer extra versatility for unique applications. These precision-made valves offer high performance, low cost, reliability, and ease of installation. Except for BFC-2C, each valve is independent of the other, sharing only a common body. This simplifies mounting while allowing separate pressures and/or gases to be used. Each needle adjustment is smooth, exact, and includes a locking ring to prevent tampering.











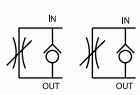
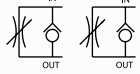

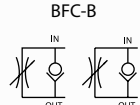
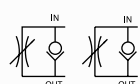
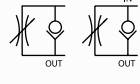
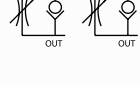

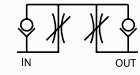
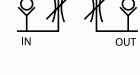
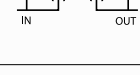
Block flow control valve bodies are machined, anodized aluminum; the compound angle needle stems are machined from 303 stainless steel; the valve sleeve is electroless nickel plated brass; and the seals are nitrile. Block flow controls and needle valves are ideal for controlling double-acting cylinders.

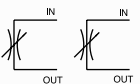
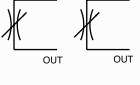
Stations	2, 4, 6, or 8
Adjustment	Screwdriver slot or knurled knob
Material	Anodized aluminum, stainless steel needle, ENP brass sleeve, nitrile seals
More Info	clippard.com/link/block-flow-controls

Precision flow controls and needle valves available in blocks for rigid mounting.

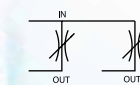

Specification same as MFC-3 (p.118)

	Style	No. of Stations	Screwdriver Slot	Knurled Knob
	BFC-A 	2	BFC-2A	BFC-2AK
		4	BFC-4A	BFC-4AK
	BFC-B 	6	BFC-6A	BFC-6AK
		8	BFC-8A	BFC-8AK
		2	BFC-2B	BFC-2BK
		4	BFC-4B	BFC-4BK
		6	BFC-6B	BFC-6BK
		8	BFC-8B	BFC-8BK
		2	BFC-2C	BFC-2CK
				
		2	BNV-2N	BNV-2NK
		4	BNV-4N	BNV-4NK
		6	BNV-6N	BNV-6NK
		8	BNV-8N	BNV-8NK
		2	BNM-2N	BNM-2NK
		4	BNM-4N	BNM-4NK
		6	BNM-6N	BNM-6NK
		8	BNM-8N	BNM-8NK

GAUGES, AIR CHOKES, VOLUME CHAMBERS & MUFFLERS

VACUUM GAUGE

Gauge measures pneumatic vacuum pressure; mounting bracket included.



Range	Scale reading from 0 to 30" Hg and 0 to -1 bar
Construction	Nickel-plated steel case. Dial shows two ranges: Hg (black) and bar (red). Built-in pressure snubber.
Ports	Double threaded: O.D. male thread 1/8" NPT, I.D. tapped for #10-32 fitting

Part No.	Description
VG-30	Vacuum Gauge

PRESSURE GAUGE

Gauge measures pneumatic system pressure; stud mounted.



Range	Scale reading from 0 to 100 psig and 0 to 6.9 bar
Construction	Steel case. Dial shows two ranges: psig (black) and bar (red). Built-in pressure snubber.
Ports	Double threaded: O.D. male thread 1/8" NPT, I.D. tapped for #10-32 fitting

Part No.	Description
PG-101-BK	Pressure Gauge, Black Case
PG-101-NP	Pressure Gauge, Nickel-Plated

PRESSURE GAUGE

Gauge measures pneumatic system pressure; mounting bracket included.



Range	Scale reading from 0 to 100 psig and 0 to 6.9 bar
Construction	Steel case. Dial shows two ranges: psig (black) and bar (red). Built-in pressure snubber.
Ports	Double threaded: O.D. male thread 1/8" NPT, I.D. tapped for #10-32 fitting

Part No.	Description
PG-100	Pressure Gauge

IN-LINE VOLUME CHAMBER

Used for providing a time delay in pneumatic circuits.

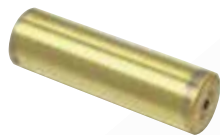

Medium: Air
Material: Brass
Input Pressure: 150 psig
Mounting: Direct or in-line; mounting clamp with MAT-2.0 and MAT-4.0

The time delay of the PV-1, PV-1P and R-711 may be increased by adding standard Clippard volume chambers. The charts below show total time vs. volume for these combinations.

Volume CU. IN.	Volume Chamber	Time in Seconds		
		Volume	PV-1	R-711
0.1	MAT-.1	0	0.042	0.117
0.25	MAT-.25	0.1	0.074	0.180
0.50	MAT-.50	0.25	0.124	0.245
1.0	MAT-1.0	0.5	0.210	0.350
1.2	R-821	1.0	0.390	0.450
2.0	MAT-2.0	1.2	0.580	0.700
2.4	R-821 (2)	2.0	0.760	1.000
3.6	R-821 (3)	2.4	0.950	1.300
4.0	MAT-4.0	3.6	1.200	1.900
		4.0	1.500	N.R.

Part No.	Description
MAT-(size)	In-Line Volume Chamber, #10-32

Specify size per chart

IN-LINE FIXED ORIFICE AIR CHOKES

Each choke is calibrated for precise flow



Medium: Air
Material: Brass
Working Range: 0 to 300 psig max.

Part No.	Description
MAC-A	Air Choke, 0.0135" Hole
MAC-B	Air Choke, 0.010" Hole
MAC-C	Air Choke, 0.0075" Hole
MAC-D	Air Choke, 0.006" Hole

SPEED CONTROL MUFFLERS

Speed control mufflers provide a variation of metering air flow at an acceptable sound level on valve exhaust ports. Knurled knob length based on minimum thread engagement. Solid brass body, sintered bronze muffler (40 micron).

Part No.	Thread
SCM-P	1/8-27 NPT
SCM-Q	1/4-18 NPT
SCM-W	3/8-18 NPT
SCM-Z	1/2-14 NPT



NEEDLE VALVES

MNV SERIES

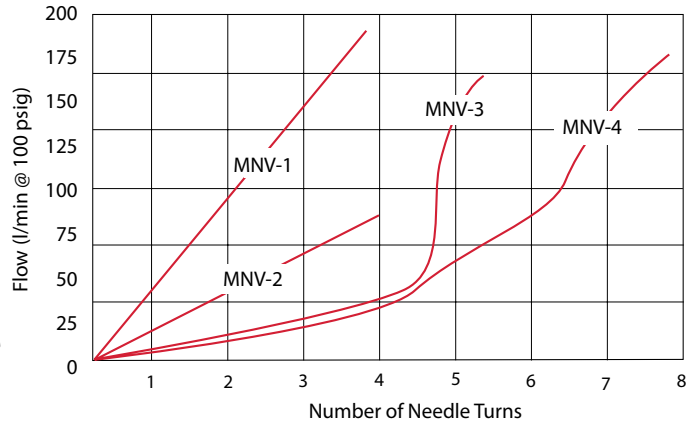
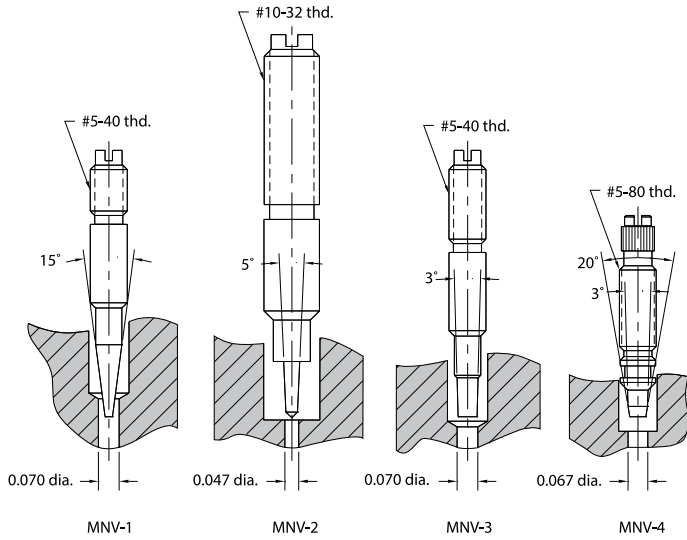

Adjustable control needle valves restrict flow in both directions. There are four models offered by Clippard, all with #10-32 ports, but with various needle configurations to provide coarse or fine flow adjustment. The diagram of needle shapes and the chart on this page show the difference between these models.

Medium

Air, water, or oil

Material

Brass body, stainless steel needle, nitrile seal

MNV-4: Anodized aluminum body

Temperature Range

32 to 230°F



	Part No.	Needle Angle	Inlet-Outlet	Input Pressure	Air Flow	Mount	Adjustment
	MNV-1	15°	#10-32-#10-32	2,000 psig max.	85 l/min @ 50 psig; 170 l/min @ 100 psig	Direct	Screwdriver slot
	MNV-1K						Knurled knob
	MNV-1P		1/8" NPT-#10-32				Screwdriver slot
	MNV-1KP						Knurled knob
	MNV-2	5°	#10-32-#10-32	300 psig max.	28 l/min @ 50 psig; 71 l/min @ 100 psig	In-line (#15/32-32 thread)	Screwdriver slot
	MNV-2K						Knurled knob
	MNV-3	3°	#10-32-#10-32	2,000 psig max.	71 l/min @ 50 psig; 140 l/min @ 100 psig	Direct	Screwdriver slot
	MNV-3K						Knurled knob
	MNV-3P		1/8" NPT-#10-32				Screwdriver slot
	MNV-3KP						Knurled knob
	MNV-4	3°	#10-32-#10-32	300 psig max.	140 l/min @ 100 psig	Direct	Screwdriver slot
	MNV-4K						Knurled knob
	MNV-4C	3°	Cartridge	150 psig max.	140 l/min @ 100 psig	Cartridge	Screwdriver slot
	MNV-4CK						Knurled knob

NEEDLE VALVES

GNV SERIES

Needle valves are used to control the rate of flow in a pneumatic system by allowing flow in both directions. The threaded adjustable needle can be screwed in to block the actuator. As a result, the flow of air not only decreases but backs up inside the actuator, preventing the actuator from generating more pressure due to the resistance. Material enters the input port, travels through an orifice and out the output port. Needle valves can be used to reverse the flow of a system or to maintain a constant flow rate. Clippard's GNV series needle valves are available with multiple port sizes, flow rates, mounting options, and adjustment styles.



Medium	Air, water, or oil
Input Pressure	300 psig max.
Mounting	Direct, in-line, or cartridge style
Material	Electroless nickel plated brass body and needle, anodized aluminum housing, nitrile seals (FKM available)

- Provide bidirectional flow control
- Rugged and compact design
- Multiple mounting options
- Ideal for use with push-quick fittings
- Rotating input allows 360° positioning
- Adjustment by recessed slotted needle or knurled knob

	Part No.	Threads	Mount	Adjustment
	GNV-3R	1/8" NPT	Direct	Screwdriver Slot
	GNV-3K			Knurled Knob
	GNV-4R	1/4" NPT	Direct	Screwdriver Slot
	GNV-4K			Knurled Knob
	GNV-5R	3/8" NPT	Direct	Screwdriver Slot
	GNV-5K			Knurled Knob
	GNV-3RI	1/8" NPT	In-Line	Screwdriver Slot
	GNV-3KI			Knurled Knob
	GNV-4RI	1/4" NPT	In-Line	Screwdriver Slot
	GNV-4KI			Knurled Knob
	GNV-5RI	3/8" NPT	In-Line	Screwdriver Slot
	GNV-5KI			Knurled Knob
	GNV-3RC	1/8" NPT	Cartridge	Screwdriver Slot
	GNV-3KC			Knurled Knob
	GNV-4RC	1/4" NPT	Cartridge	Screwdriver Slot
	GNV-4KC			Knurled Knob
	GNV-5RC	3/8" NPT	Cartridge	Screwdriver Slot
	GNV-5KC			Knurled Knob

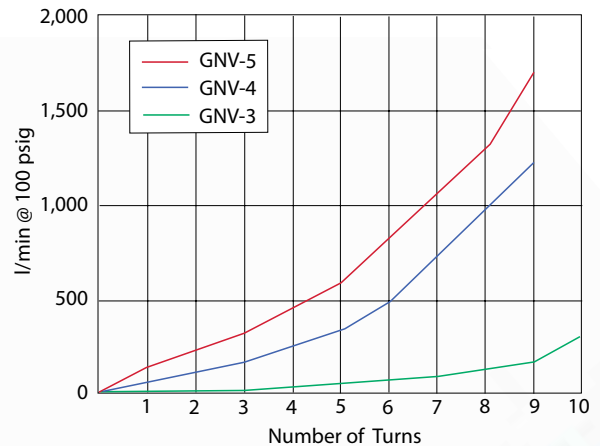

AIR FLOW **GNV-3:** 310 l/min @ 100 psig
GNV-4: 1,250 l/min @ 100 psig
GNV-5: 1,700 l/min @ 100 psig



CLIPPARD PUSH-QUICK FITTINGS provide a simple method to connect pneumatic components to each other and system piping, and accept both flexible hose and rigid tubing. Both fittings and tubing are available in many styles, sizes and colors.

PRESSURE REGULATORS

DR-1 PRECISION REGULATORS*

COMING SOON!

Building on more than 50 years of experience designing and manufacturing miniature regulators, Clippard is responding to your need for pressure regulation that is more stable and more accurate. Compatible with a variety of liquids and gases, the new DR-1* series raises the bar on performance and value for miniature pressure regulators.

For the latest details, visit clippard.com/link/dr1

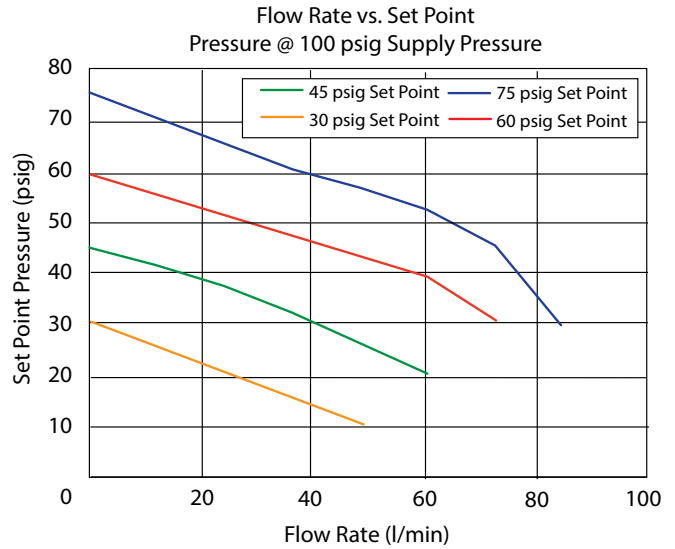

- Exceptional repeatability— ± 0.1 psi
- Set point sensitivity 0.1 psi
- Set point stability: 0.1 psi
- Features a non-relieving design

**Specifications not yet final. Visit clippard.com/link/dr1 for the latest details.*

COMPARISON CHART

DR-1 Series*

DR-2 Series

MAR-1 Series



Accuracy

Exceptional

Excellent

Fair

Repeatability

Exceptional

Exceptional

Fair

Flow Rate vs. Set Point Pressure

Best

Good

Fair

Lifespan

Excellent

Excellent

Excellent

Cost

\$\$\$

\$\$

\$

PRESSURE REGULATORS

DR-2 PRECISION REGULATORS



- Designed for applications where zero air consumption is required (non-bleed)
- Exceptional accuracy and repeatability
- Excellent corrosion resistance
- Relieving and non-relieving designs
- Manifold mount option
- Features non-rising internal adjustment

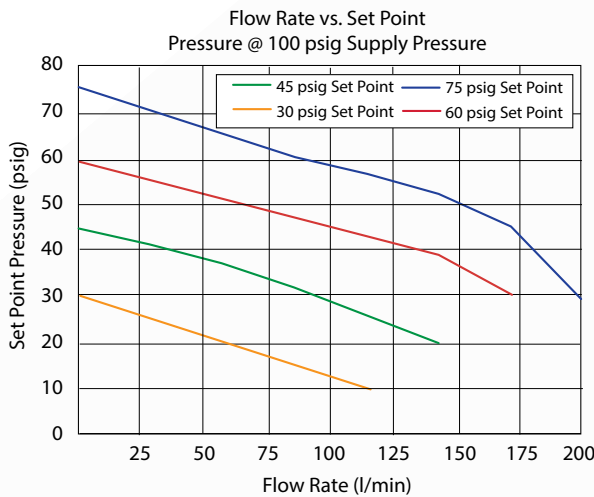

When Clippard invented miniature regulators in 1962, the MAR series (p. 126) became very popular as a simple, robust, cost-effective regulator with exceptionally long life. Today, the new DR-2 series maintains this same flow, performance, and durability while providing greater accuracy and repeatability in a sleek, compact package.

Regulators are offered in either relieving or non-relieving versions. The relieving design maintains a constant pressure output even when downstream conditions change, while non-relieving regulators do not automatically compensate for changes in downstream flow or pressure. There is no vent to atmosphere, as in a relieving type regulator, and the output pressure can increase due to a downstream event. Non-relieving versions can also accommodate compatible liquid applications.

Medium	Relieving: Air Non-Relieving: Air, water, or oil
Input Pressure	300 psig max.
Repeatability	±0.1 psi typical (±0.15 psi max.)
Set Point Sensitivity	0.1 psi
Set Point Stability	0.1 psi
Temperature Range	32 to 230°F
Mounting	#15/32-32 thread; nuts & lockwashers furnished
Material	Electroless nickel plated brass body, FKM seals, PFPE lube, stainless steel adjustment screw and spring
Adjustment	An extended 0.25" shaft accepts an adjustment knob or furnished with an exposed screwdriver slot with micro-adjustment (32 pitch thread). Knobs ordered separately (#AK4-A)
More Details	clippard.com/link/dr2

Not recommended for applications where accurate dead-end, no flow is required.

ORDERING INFORMATION

Example Part Number:

DR-2BP-5

Consult Clippard for special configurations, preset options, or metric versions.

Inlet	Outlet
#10-32 Female	#10-32 Female
1/8" NPT Male	#10-32 Female
#10-32 Male	Manifold
Cartridge	Cartridge
1/8" NPT Male	1/8" NPT Female

Base Part No.

- DR-2
- DR-2P
- DR-2M
- DR-2C
- DR-2BP



Type

- (blank) Relieving
- NR Non-Relieving

Max. Pressure Range

- (blank) 2 - 100 psig
- 1 0.5 - 10 psig
- 5 1 - 50 psig

PRESSURE REGULATORS

MAR-1 REGULATORS



Medium	Relieving: Air Non-Relieving: Air, water, or oil
Input Pressure	300 psig max.
Air Flow	85 l/min @ 50 psig; 140 l/min @ 100 psig
Temperature Range	32 to 230°F
Mounting	#15/32-32 thread
Material	Brass body, nitrile seals (FKM available), stainless steel stem and spring
Adjustment	Knob with micro-adjustment (40 pitch thread); screwdriver slot and plastic adjustment also available 1C & 1CP: As plunger is depressed, pressure increases proportionally to the travel; when plunger is released, input is closed and output pressure is exhausted to atmosphere; 7/32" plunger travel
More Details	clippard.com/link/mar

Since 1962, the MAR-1 has remained a popular choice as a simple, robust, cost-effective regulator in a small package with exceptionally long life. As regulator applications continue to increase, Clippard continues to meet the demand with a variety of new models, options and improvements.

Regulators are offered in either relieving or non-relieving versions. The relieving design maintains a constant pressure output even when downstream conditions change, while non-relieving regulators do not automatically compensate for changes in downstream flow or pressure. There is no vent to atmosphere, as in a relieving type regulator, and the output pressure can increase due to a downstream event. Non-relieving versions can accommodate compatible liquid applications.



FKM seals and electroless nickel plating also available



ORDERING INFORMATION

Inlet	Outlet	Base Part No.	Adjustment	Type	Max. Pressure Range
#10-32 Female	#10-32 Female	MAR-1	(blank) Knurled knob	(blank) Relieving	(blank) 10 to 100 psig
1/8" NPT Male	#10-32 Female	MAR-1P	K Plastic knob	NR Non-Relieving	2 10 to 20 psig
#10-32 Male	Manifold	MAR-1M	F Screwdriver slot		3 10 to 30 psig
Cartridge	Cartridge	MAR-1R	C Plunger style*	NR not available on C & CP models	4 10 to 40 psig
1/8" NPT Male	1/8" NPT Female	MAR-1BP			5 10 to 50 psig
					6 10 to 60 psig
					7 10 to 70 psig

Example Part Number:

MAR-1BP-2

*Available in relieving version for MAR-1 and MAR-1P only

SHUTTLE VALVES

MSV & JSV SERIES

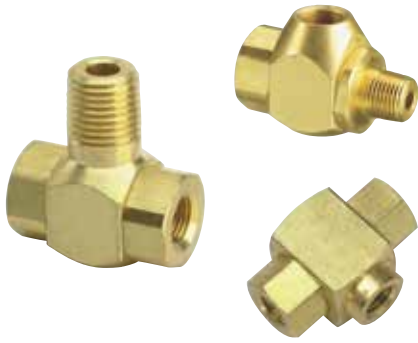

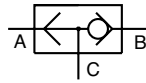

#10-32, 1/16" NPT,
1/8" NPT & 1/4" NPT Ports



These three shuttle valve models feature a shuttle that allows flow from one inlet to the outlet while blocking the other inlet. They may be mounted directly to valves and cylinders or in-line.

- Medium** Air, water, or oil
- Input Pressure** **MJSV/JSV:** 300 psig max.; **MSV:** 250 psig max.
- Mounting** Direct or in-line
- Exhaust** Through port where pressure was last applied
- Material** Brass body, stainless steel shuttle, nitrile seal
MJSV: Zytel® 80G33 shuttle; **MSV:** Brass shuttle
- Note** Shuttle valves should not be used as a pressure selector

Part No.	Inlet 1	Inlet 2	Outlet	Force to Shift	Air Flow
 MJSV-1	1/8" NPTF	1/8" NPTF	1/8" NPTF	1/2 psig	400 l/min @ 50 psig; 740 l/min @ 100 psig
 JSV-2FPF JSV-2PFF JSV-2WFF JSV-2WYY JSV-2YFF JSV-2YWY JSV-2YYY	1/8" NPTF 1/8" NPTF 1/8" NPTF 1/4" NPTF 1/8" NPTF 1/4" NPTF 1/4" NPTF	1/8" NPTM 1/8" NPTF 1/8" NPTF 1/4" NPTF 1/8" NPTF 1/4" NPTM 1/4" NPTF	1/8" NPTF 1/8" NPTM 1/4" NPTM 1/4" NPTF 1/4" NPTF 1/4" NPTF 1/4" NPTF	1 psig	850 l/min @ 50 psig; 1,400 l/min @ 100 psig
 MSV-1 MSV-1FFF	#10-32F #10-32F	#10-32F #10-32F	#10-32M #10-32F	1/2 psig	140 l/min @ 50 psig; 270 l/min @ 100 psig

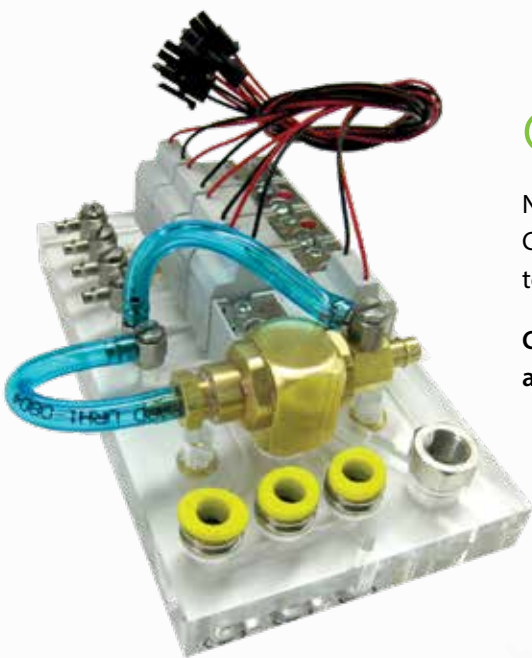

Custom Solutions

Need a product that fits your application perfectly? Clippard can design or modify standard products to suit your *exact* needs.

Call **877-245-6247** today to discuss your application and specific requirements.

PULSE VALVES, SENSORS & AIR INDICATORS

PULSE VALVES



A Normally-Open 3-Way valve that closes shortly after being pressurized and remains closed until supply pressure is exhausted and re-pressurized. Widely used in control circuits.

Part No.	Description
PV-1	Pulse Valve, #10-32
PV-1P	Pulse Valve, 1/8" NPT

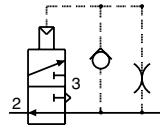

Medium	Air
Input Pressure	40 to 150 psig max.
Mounting	1/8" NPT thread; nut furnished
Volume Chamber	#10-32
Operation	Converts continuous supply of inlet air into pulse of approx. 100 ms
Material	ENP brass body and poppet, nitrile seals, stainless steel spring

Time delay may be increased with Clippard volume chambers (not to exceed 3 cu. in.)

NON-CONTACT GAP SENSOR

Will sense any flat or round object with a 1/32" min. radius. Produces positive signal when no object present; negative signal when an object interrupts its sensing system.



Medium	Air
Input Pressure	0.5 to 5 psig
Output	-3" to 26" H ₂ O @ 4 psig
Frequency Response	1,000 cpm
Air Consumption	7.1 l/min @ 4 psig
Sensing Capability	Flat or curved surfaces with 1/32" min. radius. May be used for up to 4" gap with an additional auxiliary jet
Connections	#10-32 female
Material	Solid brass bright dipped

Part No.	Description
1030	Non-Contact Gap Sensor, #10-32

NON-CONTACT AIR PROXIMITY SWITCH

No moving parts—will sense any flat or curved object which presents a sensing surface of 1/4" or more to the sensing nozzle.



Medium	Air
Input Pressure	4 to 10 psig
Proximity Distance	0.100" nominal
Output Signal @ 4 psig Supply	Normal: -2" H ₂ O Actuated: 7-1/2" H ₂ O
Frequency Response	500 CPM
Air Consumption	8.5 l/min
Sensing Capability	Flat or curved surfaces with 1/8" min. radius
Connections	#10-32 female
Material	Solid brass bright dipped

Part No.	Description
1022	Non-Contact Air Limit Switch, #10-32

2-WAY N-C WHISKER VALVES

For use with bleed pressure piloted control circuits. Whisker is easily replaceable and can be formed to different shapes.

Medium	Air
Input Pressure	150 psig
Air Flow	28 l/min @ 50 psig; 42 l/min @ 100 psig
Force for Stem Travel	1/4 oz. approx.
Bleed	To atmosphere around whisker stem
Whisker	Stainless steel, approx. 3" length.

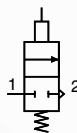
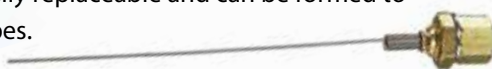

Part No.	Description
MWV-1	Normally-Closed Whisker Valve, #10-32
MWV-1P	Normally-Closed Whisker Valve, 1/8" NPT

MULTI-PIN AIR INDICATOR

Plunger type (when extended 7-pin color display signals "on")

Medium	Air only
Input Pressure	15 to 150 psig
Response	Approx. 10 ms @ 50 psig
Filtration	40 micron recommended
Panel Thickness	3/16" max.
Mounting	IND-3: Panel mount, #15/32-32 nut & lockwasher provided; IND-3P: Direct mount, 1/8" NPT hole



Part No.	Description
IND-3-(color)	Multi-Pin Air Indicator, #10-32
IND-3P-(color)	Multi-Pin Air Indicator, 1/8" NPT

GN - ● WH - ○ RD - ● YL - ●

SWITCHES & WATER DRAWBACK VALVES

WATER DRAWBACK VALVES



When this N.C. valve closes, a spring biased internal piston draws back a small volume on outlet side (approx. 6-7" in 1/8" I.D. tube) preventing overflow.

Part No.	Description
WDV-2	Poppet Valve with Air Pilot, #10-32
WDV-2P	Poppet Valve with Air Pilot, 1/8" NPT

Medium	Water or other light liquids
Input Pressure	100 psig max.
Pilot Pressure	25 psig min.
Flow	74 cu. in. H ₂ O per min. @ 80 psig
Drawback	0.07 cubic inches (1.2 mL)
Mounting	In-line
More Details	clippard.com/link/drawback

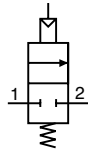

Ideal for use in quenching or water spray applications.

PRESSURE ACTUATED SWITCHES



These miniature (**MAS**) and sub-miniature (**SAS**) air switches utilize a single pole, double throw (SPDT) electrical switch. Manual models may be used with Clippard air pilot or push-button actuators.

Medium	Air
Input Pressure	5 to 150 psig
Pilot Port	#10-32, 1/8" NPT
Mounting	External thread and nut for panel, bracket, or bulkhead mounting—5/8-32 pressure actuated, 15/32-32 manually operated
Accuracy	Actuation pressures listed are nominal values only*
More Details	clippard.com/link/sas-mas

*For applications where a tight tolerance for actuation or deactuation is needed, please call 877-245-6247.

ORDERING INFORMATION



SAS Sub-Miniature Air Switch
MAS Miniature Air Switch

Switch Current Rating

SAS
A 5A @ 125/250 VAC
 3A @ 30 VDC/.1A 60 VDC
X No switch

MAS

B 3A @ 125/250 VAC
 3A @ 30 VDC
C 10A @ 125/250 VAC
 5A @ 50 VDC
X No switch

Nominal Actuation Pressure*

06 6 psig
20 20 psig
40 41 psig
65 65 psig
MN Manual

Inlet Port

Blank #10-32 thd.
F 1/8" NPT female
P 1/8" NPT male

Switch Terminals

SAS 0 No switch
1 110 series Q.C.

MAS 0 No switch
2 187 series Q.C.
3 Screw terminals

SINGLE POLE ELECTRICAL SWITCH



ES series switches are used in conjunction with MPA series actuators (p. 90)

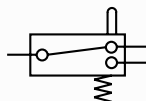

Part No.	Description
ES-1 15601	Single Pole, Double Throw Snap-Action Electrical Switch Terminal Cover

Stem Travel	1/8"
Rating, AC	120, 240, or 480 volts (15 amperes)
Rating, DC	125 volts (0.5 amperes) 250 volts (0.25 amperes)
Approvals	UL, CE
Mounting	#15/32-32 thread; nut and lockwashers furnished; two 0.140" dia. mounting holes in body
More Details	clippard.com/link/es-1

Cylinders

In the early 1950s, Clippard introduced miniature pneumatic cylinders and valves to the industry. No other manufacturer can match Clippard's level of experience or knowledge of miniature components. Need to replace a cylinder from another manufacturer? Clippard's online Interchange Guide makes it easy—simply search the other manufacturer's part number online at clippard.com and the Interchange will display the most similar Clippard cylinder, along with a full comparison of specifications.

Clippard manufactures a wide variety of special cylinders with custom stroke and rod modifications, special mounting configurations and ports, special seals and lubrication, unique integrated valving, and more. Call **877-245-6247** today to discuss how we can help you optimize your system with the perfect components for your application.



 **Interchange**
GUIDE



STAINLESS STEEL

- Over 130 different models
- 14 bore sizes
- Superior design and long life
- Thousands of items in stock for same-day shipping

pp. 136-147



ALL STAINLESS STEEL

- Durable 303 and 304 stainless steel
- 4 bore sizes
- FDA compliant grease lubrication
- Wipers standard

pp. 148-151



CORROSION-RESISTANT

- Durable 303 and 304 stainless steel
- FDA compliant grease lubrication
- Wipers standard
- 5 bore sizes

pp. 152-155



COMPACT EXTRUDED

- Interchangeable design allows for quick drop-in replacements
- 7 bore sizes
- Compact design for tight spaces

pp. 156-159



BRASS

- Original miniature cylinder line
- 4 bore sizes
- Robust, heavy-duty design
- Hydraulic or pneumatic

pp. 160-162



AIR VOLUME TANKS

- 10 standard models
- 1 to 16 cubic inches
- Custom sizes available
- Available in stainless, all stainless and polypropylene

p. 163

POSITION SENSORS p. 166

ACCESSORIES p. 164

Many items also available with metric ports.
For more information, visit clippard.com/link/metric

CYLINDERS

AVAILABLE OPTIONS

The following options are available for select Clippard cylinders.

Please note that not all options are available for all cylinders. Consult the charts (pp. 136-162) to see which options are available for a particular cylinder line or model.

CUSHIONS (C, F, R)

Provide adjustment to slow the cylinder near the end of the stroke, reducing impact and prolonging the life of the cylinder. Clippard cylinder cushions feature a captive adjustment that can be adjusted up to a dead stop 1/2" from the end of the stroke.

Read More: p. 134

MAGNETIC PISTON (M)

Equips the cylinder with an internal magnet, allowing it to be used with a reed switch or GMR sensor for accurate positioning.¹

Read More: p. 166

BUMPERS (B)

Reduce noise and shock to the load in applications where the cylinder is cycled with a light load and/or high speeds.¹

Max. Temperature: 200°F

WIPERS (W)

Added to cylinders to prevent contaminants from entering the cylinder assembly system.

Wipers are included standard on the All Stainless Steel line (no need to add a -W suffix to the part number).

FKM SEALS (V)

Used in applications which require special chemical compatibility or more extreme temperatures.

Temperature Range: -20 up to 400°F

ROD THREADS (N)

Various rod thread sizes are available, refer to cylinder charts for specifications. Rods are also available with no threads (N).

SIDE PORTED (S)

Side ported rear heads are sometimes needed when the standard cylinder has the rear port out the back. This option changes the design of the rear head so the rear port is located on the side of the cylinder.¹

HEAVY SPRING (H)

In single-acting, reverse-acting, or spring bias cylinders, this option provides a heavier spring to increase the standard spring force.

Standard and heavy spring forces are listed in Spring Forces Chart, p. 135

ROTATED PORTS (P2-8)

For applications where ports need to be rotated to accommodate specific space requirements or specific port orientation for fittings and tube attachments.

See diagram and chart (right)

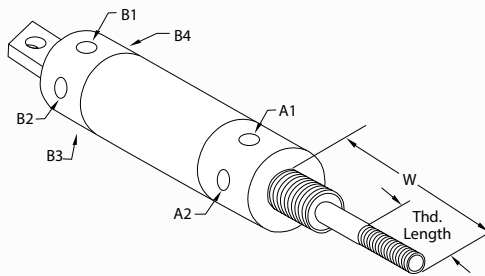

Option No.	Rear Port	Front Port
P2	B2	A2
P3	B1	A2
P4	B4	A2
P5	B3	A2
P6	B4	A1
P7	B3	A1
P8	B2	A1

PTFE GREASE (TG)

Seals lubricated with PTFE grease.

METRIC (M- prefix)

Compact Extruded line only.

ROD EXTENSIONS

If a special rod extension is required, refer to drawing above. For extensions on single- or double-acting cylinders, indicate desired "W" when rod is at rest with no pressure to either port. For reverse-acting, indicate "W" when rod is at rest with no pressure to either port.

LARGE ROD (LR)

Available on 1-1/4" bore round body line only.

¹Use of this option may add to the overall length of the cylinder.

CYLINDERS

CYLINDER & ROD TYPES

Cylinder Types

Single-Acting (S)

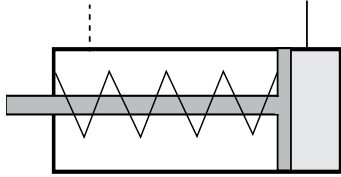

Single-acting cylinders provide power only on the extension ("push") stroke. A separate force—an internal spring—returns the piston to its original position for the next stroke.

Double-Acting (D)

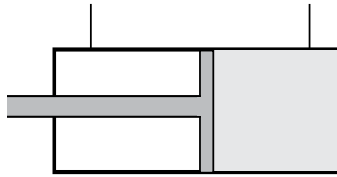

Double-acting cylinders have dual pressure chambers and provide pneumatic power on both extension ("push") and retraction ("pull"), eliminating the need for a spring.

Reverse-Acting (R)

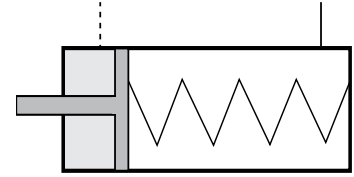

Reverse-acting cylinders are similar to single-acting but with a port on the opposite end to provide power only on the retraction ("pull") stroke.

Front Spring Bias (F)

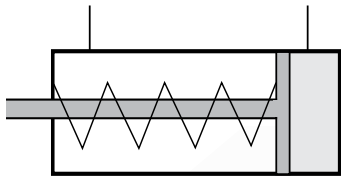

Front spring bias cylinders are double-acting cylinders with the addition of a spring on the front end. If all air is removed from the cylinder, the front spring bias cylinder will behave like a single-acting cylinder and shift to the retracted position.

Rear Spring Bias (B)

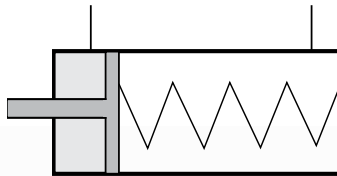

Rear spring bias cylinders are double-acting cylinders with the addition of a spring on the back end. If all air is removed from the cylinder, the rear spring bias cylinder will behave like a reverse-acting cylinder and shift to the extended position.

Rod Types

- **Double-Ended*** (D)
- **Rotating** (R)
- **Non-Rotating** (N)
- **Hollow** (H)

**Double-Acting cylinders only*

Need to replace a cylinder from another manufacturer?

Clippard's online **Interchange Guide** makes it easy to identify Clippard cylinders that are compatible with cylinders from other manufacturers. Just enter your cylinder part number into any search box on the clippard.com website to see a comparison.

clippard.com/link/interchange



CYLINDERS

CUSHIONS

Pneumatic cushions decelerate the piston and rod assembly at the end of the cylinders travel, reducing internal impact force/noise and enabling faster piston velocities. In fast cycling applications, cushioned cylinders will provide superior life and a better machine environment.

- Easily accessible, stainless steel needle for fine adjustment of cushion
- Long-lasting nitrile cushion seal
- Cushions the last 1/2" of stroke
- Available at front, rear, or both ends of cylinder
- Available with magnetic pistons

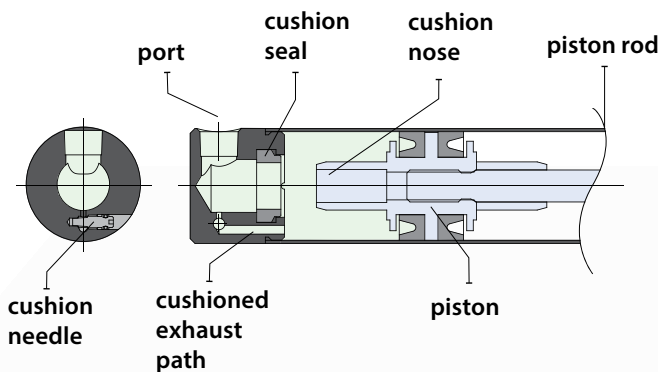

Cushions cannot be added to existing cylinders because this option requires additional components and machining. A cushion nose is located on either or both sides of the piston, depending on which cushion option is selected. The heads of a cushioned cylinder have a cushion pocket with a cushion seal. When the cushion nose enters the cushion seal, the air exiting the cylinder is trapped causing it to compress. This provides a resistance force that decelerates the piston.

In this design, a needle valve in the head provides a parallel path for the air to exit and is used to fine-tune the cushion's effectiveness. This needle design has a high flow gain which allows the user to tune the cushion anywhere from little effect to actually stopping the cylinder. The cushion seal collapses when air coming through the adjacent port is introduced, allowing for a fast breakaway.

CYLINDERS AVAILABLE WITH CUSHIONS

Bore Size	Part No.	Mounting	Both (C)	Front (F)	Rear (R)	Pg.
3/4"	SDD-12-	Stud	•	•		140
	SDH-12-	Stud	•	•	•	
	SDR-12-*	Stud	•	•	•	
	UDR-12-	Universal	•	•	•	
7/8"	SDD-14-	Stud	•	•		141
	SDH-14-	Stud	•	•		
	SDR-14-*	Stud	•	•	•	
	UDR-14-	Universal	•	•	•	
1-1/16"	SDD-17-	Stud	•	•		142
	SDH-17-	Stud	•	•	•	
	SDR-17-*	Stud	•	•	•	
	UDR-17-	Universal	•	•	•	
1-1/4"	SDD-20-	Stud	•	•		143
	SDR-20-*	Stud	•	•	•	
	UDR-20-	Universal	•	•	•	
1-1/2"	CDR-24-	Clevis	•	•	•	144
	EDR-24-	End Stud	•	•	•	
	SDD-24-	Stud	•	•		
	SDR-24-*	Stud	•	•	•	
1-3/4"	SDD-28-	Stud	•	•		145
	SDR-28-	Stud	•	•	•	
	UDR-28-	Universal	•	•	•	
2"	SDD-32-	Stud	•	•		146
	SDR-32-*	Stud	•	•	•	
	UDR-32-	Universal	•	•	•	
2-1/2"	SDD-40-	Stud	•	•		147
	SDR-40-*	Stud	•	•	•	
	UDR-40-	Universal	•	•	•	

1-1/16" and 1-1/2" bore cylinders with only one cushion include bumpers on the non-cushioned end

*SDR- models have side ported rear heads

Cushioned cylinders are not designed to decelerate machine members or take the place of shock absorbers in applications with high kinetic energy. Note also that bumpers cannot be used with cushions, but can be used opposite a cushion (as with the 1-1/16" and 1-1/2" bore cylinders).

CYLINDERS

FORCE FACTORS

The chart shown at right can be used to calculate cylinder force. The "force factors" listed indicate the nominal area for the bore and rod sizes shown. To calculate cylinder force, multiply the appropriate extend or retract force factor by the pressure being used. Clippard also recommends adding a 25% safety factor for normal load movement, or 40% for high speed applications.

FORCE FACTOR x **P** (Pressure) = **F** (Force)

F x **1.25** (25% Safety Factor) = **Normal Load Movement**

F x **1.40** (40% Safety Factor) = **High Speed Applications**

To calculate your own force factors:

A (Area) = **Radius**² x **π** (or **Diameter**² x 0.7854)

F = **P** x **A**

BORE SIZE	ROD SIZE	AREA OF ROD	EXTEND ¹	RETRACT ²
5/16"	1/8"	0.01 in ²	0.07 in ²	0.06 in ²
1/2"			0.19 in ²	0.16 in ²
9/16"	3/16"	0.03 in ²	0.25 in ²	0.22 in ²
5/8"			0.31 in ²	0.28 in ²
3/4"	1/4"	0.05 in ²	0.44 in ²	0.39 in ²
7/8"			0.60 in ²	0.55 in ²
1-1/16"	5/16"	0.08 in ²	0.88 in ²	0.80 in ²
1-1/4"	3/8"	0.11 in ²	1.20 in ²	1.09 in ²
1-1/2"	7/16"	0.15 in ²	1.70 in ²	1.55 in ²
1-3/4"	1/2"	0.20 in ²	2.40 in ²	2.20 in ²
2"	5/8"	0.31 in ²	3.10 in ²	2.90 in ²
2-1/2"			4.90 in ²	4.59 in ²
3"	3/4"	0.44 in ²	7.00 in ²	6.56 in ²

¹Area of bore; ²Area of bore minus area of rod

MAXIMUM LOAD BY ROD LENGTH

BORE SIZE	ROD SIZE	1"	5"	10"	15"	20"	25"	30"	35"	40"
5/16"	1/8"	110 lbs.	12 lbs.	3 lbs.	1.3 lbs.					
1/2"										
9/16"	3/16"	262 lbs.	59 lbs.	15 lbs.	6.6 lbs.	3.7 lbs.				
5/8"										
3/4"	1/4"	478 lbs.	190 lbs.	47 lbs.	21 lbs.	12 lbs.	7.5 lbs.			
7/8"										
1-1/16"	5/16"	756 lbs.	451 lbs.	116 lbs.	52 lbs.	29 lbs.	19 lbs.	13 lbs.		
1-1/4"	3/8"	1,091 lbs.	786 lbs.	240 lbs.	106 lbs.	60 lbs.	38 lbs.	27 lbs.	20 lbs.	
1-1/2"	7/16"	1,490 lbs.	1,184 lbs.	444 lbs.	197 lbs.	111 lbs.	71 lbs.	49 lbs.	36 lbs.	28 lbs.
1-3/4"	1/2"	1,950 lbs.	1,645 lbs.	757 lbs.	336 lbs.	189 lbs.	120 lbs.	84 lbs.	62 lbs.	47 lbs.
2"	5/8"	3,055 lbs.	2,750 lbs.	1,795 lbs.	821 lbs.	462 lbs.	295 lbs.	205 lbs.	150 lbs.	115 lbs.
2-1/2"										
3"	3/4"	4,405 lbs.	4,100 lbs.	3,140 lbs.	1,700 lbs.	950 lbs.	613 lbs.	425 lbs.	312 lbs.	240 lbs.

SPRING FORCES

STANDARD	5/16"	1/2"	9/16"	5/8"	3/4"	7/8"	1-1/16"	1-1/4"	1-1/2"	1-3/4"	2"	2-1/2"
At Rest	0.5 lbs.	0.9 lbs.	1.7 lbs.	1.3 lbs.	3.0 lbs.	3.0 lbs.	2.0 lbs.	4.5 lbs.	4.5 lbs.	11.0 lbs.	15.0 lbs.	15.0 lbs.
Compressed	1.0 lbs.	2.0 lbs.	4.0 lbs.	4.0 lbs.	6.0 lbs.	6.0 lbs.	7.0 lbs.	10.0 lbs.	10.0 lbs.	24.0 lbs.	30.0 lbs.	30.0 lbs.
HEAVY												
At Rest	—	2.0 lbs.	—	3.3 lbs.	5.0 lbs.	5.0 lbs.	5.5 lbs.	8.5 lbs.	8.5 lbs.	—	—	—
Compressed	—	4.0 lbs.	—	9.0 lbs.	10.0 lbs.	10.0 lbs.	13.0 lbs.	17.0 lbs.	17.0 lbs.	—	—	—

Stainless Steel

Clippard's stainless steel air cylinders are manufactured to the highest standards of quality and reliability. Featuring a precision rolled body construction, this line is designed for long life, leak-free, low maintenance performance. In addition to quality and performance, Clippard's stainless steel cylinders provide superior design flexibility with a wide range of bore sizes from 5/16" up to 3" as well as a variety of mounting styles. Options available include magnetic pistons and rod wipers.

- High quality, precision rolled construction
- Low maintenance, durable design
- Low breakaway forces provide long life
- Wide variety of interchangeable mounting styles
- Over 130 different models
- Bore sizes from 5/16" up to 3"
- Magnetic pistons available
- Rod wipers available
- Thousands of versions in stock and available for same-day shipping

Bore Size	5/16" up to 3"
Cylinder Type	Single-Acting, Reverse-Acting, Double-Acting, or Spring Bias
Material, Bushing	Bronze
Material, End Caps	Aluminum
Material, Rod	304 Stainless steel
Material, Seal	Nitrile standard, FKM available
Material, Tube	303 Stainless steel
Mounting Style	Universal, stud, trunion, front block, clevis, or end stud
Pressure, Max.	250 psig
Rod Type	Rotating, non-rotating, or double end
Temperature, Max.	230°F (400°F with FKM)
Temperature, Min.	32°F (-20°F with FKM)
More Info	clippard.com/link/cyl-ss

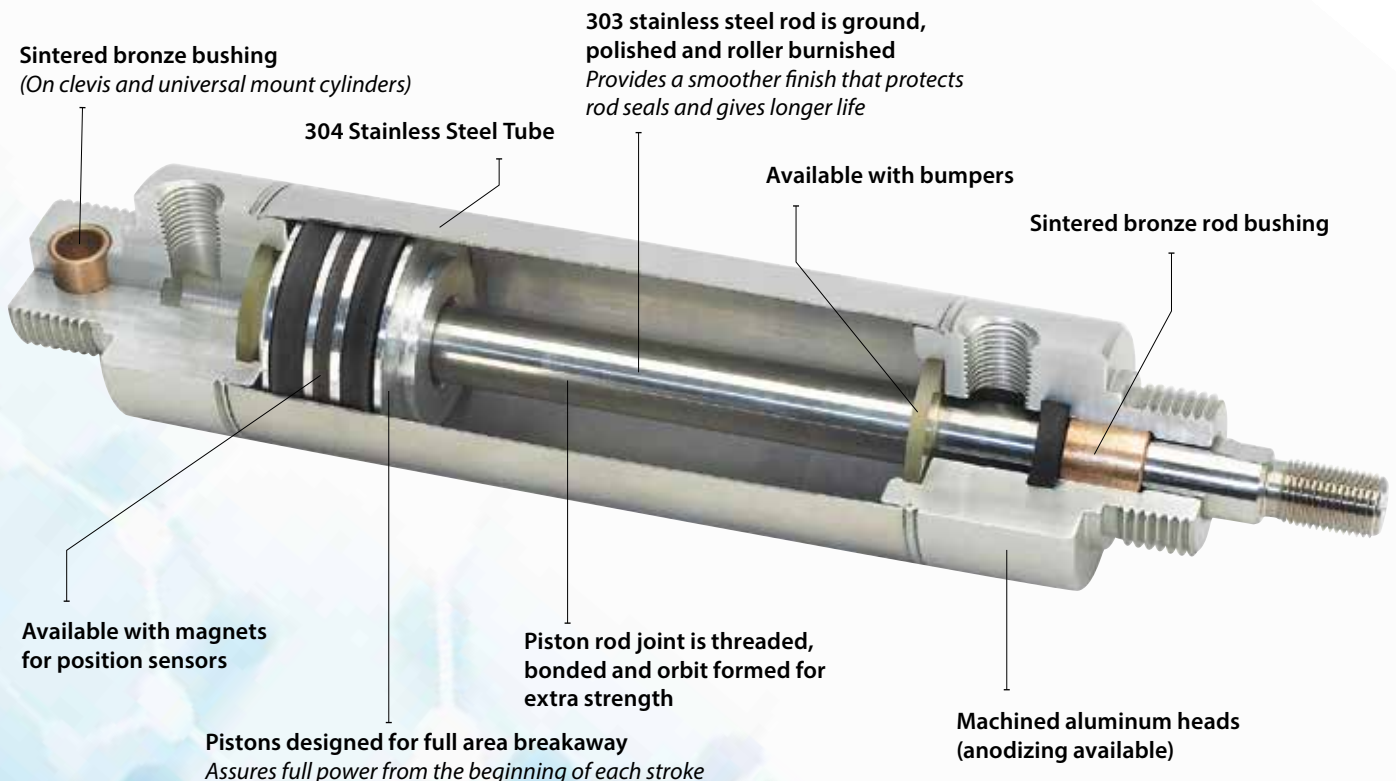

Mounting Styles



Stud, Front (S)



Universal (U)



Clevis (C)



Block, Front (F)



Stud, End (E)



Trunnion (T)

ORDERING INFORMATION

Please Note: Not all possible configurations shown below are available. Please reference the charts on the preceding pages for complete details or visit clippard.com/link/cyl-ss to use our online configurator.

After selecting a cylinder from one of the charts, simply add your **stroke** and **options** to the end of the **base part number** listed in the chart. This will provide the complete part number for your cylinder.

BASE PART NO.

-

-

Mounting Style	Rod Type	Stroke	Options
S Stud, Front	D Double-Ended	Inches and fractions of an inch (e.g. 1 or 1 1/2)	C Cushions
U Universal	N Non-Rotating	<i>Refer to charts (pp. 138-147) for maximum stroke length</i>	F Cushion, Front
C Clevis	R Rotating		R Cushion, Rear
F Block, Front	H Hollow		M Magnetic Piston
E Stud, End			B Bumpers
T Trunnion			W Rod Wiper
	Cylinder Type		V FKM Seals
	S Single-Acting		N No Threads
	D Double-Acting		S Side Ported
	R Reverse-Acting		H Heavy Spring
	F Front Spring Bias		P Rotated Ports
	B Rear Spring Bias		TG PTFE-Based Grease
			A Anodized

Mounting styles are pictured above

Cylinder types are described in more detail on p. 133

Cylinder options are described in more detail on p. 132

STAINLESS STEEL

5/16" & 1/2" BORE CYLINDERS

BORE SIZE 5/16"

Base Part No.	SSR-05-	USR-05-	SDR-05-	UDR-05-	SRR-05-	URR-05-	
Cylinder Type	Single-Acting		Double-Acting		Reverse-Acting		
Mounting Style	Stud	Universal	Stud	Universal	Stud	Universal	
Rod Type	Rotating	•	•	•	•	•	
	Non-Rotating						
Maximum Stroke	29"	29"	43"	43"	17"	17"	
Standard Rod Threads	#5-40						
Options	Cushions (C, F, R)						
	Magnetic Piston (M)						
	Bumpers (B)	B	B	B	B	B	B
	Wipers (W)						
	FKM Seals (V)	V	V	V	V	V	V
	Side Ported (S)	S		S			
	Heavy Spring (H)						
	Other Rod Threads						
Threadless	N	N	N	N	N	N	
Rotated Port Configurations <i>(See chart, p. 132)</i>		P6	P6, 7, 8	P2, 3, 4, 5, 6, 7, 8		P2, 3, 4, 5, 6, 7, 8	

Part Numbering Schematic



BORE SIZE 1/2"

Base Part No.	FSR-08-	SSN-08-	SSR-08-	USN-08-	USR-08-	FDR-08-	SDR-08-	SDD-08-	UDR-08-	SRR-08-	URR-08-
Cylinder Type	Single-Acting					Double-Acting			Reverse-Acting		
Mounting Style	Front Block	Stud	Stud	Universal	Universal	Front Block	Stud	Stud	Universal	Stud	Universal
Rod Type	Rotating	•	•	•	•	•	•	Double End	•	•	•
	Non-Rotating		•	•	•						
Maximum Stroke	23"	23"	23"	23"	23"	43"	43"	20"	42"	15"	15"
Standard Rod Threads	#10-32										
Options	Cushions (C, F, R)										
	Magnetic Piston (M)	M	M	M	M	M	M	M	M	M	M
	Bumpers (B)	B	B	B	B	B	B	B	B	B	B
	Wipers (W)	W		W		W		W		W	
	FKM Seals (V)	V	V	V	V	V	V	V	V	V	V
	Side Ported (S)	S	S	S			S	S			
	Heavy Spring (H)	H	H	H	H	H				H	H
	Other Rod Threads	Specify option N1, N2, or N3: #10-24 (N1) • M5x0.8 (N2) • #8-32 (N3)									
Threadless	N	N	N	N	N	N	N	N	N	N	N
Rotated Port Configurations <i>(See chart, p. 132)</i>				P6	P6	P6, 7, 8	P6, 7, 8	P6, 7, 8	P2, 3, 4, 5, 6, 7, 8		P2, 3, 4, 5, 6, 7, 8

STAINLESS STEEL

9/16" BORE CYLINDERS

BORE SIZE

9/16"

Base Part No.	USN-09-	USR-09-	SSN-09-	SSR-09-	SDD-09-	SDR-09-	UDR-09-	SRR-09-	URR-09-
Cylinder Type	Single-Acting				Double-Acting			Reverse-Acting	
Mounting Style	Universal	Universal	Stud	Stud	Stud	Stud	Universal	Stud	Universal
Rod Type	Rotating	•		•	Double End	•	•	•	•
	Non-Rotating	•		•					
Maximum Stroke	23"	23"	23"	23"	20"	43"	43"	15"	14"
Standard Rod Threads	#10-32								
Options	Specify option N1, N2, or N3: #10-24 (N1) • M5x0.8 (N2) • #8-32 (N3)								
Cushions (C, F, R)									
Magnetic Piston (M)	M	M	M	M	M	M	M	M	M
Bumpers (B)	B	B	B	B	B	B	B	B	B
Wipers (W)									
FKM Seals (V)	V	V	V	V	V	V	V	V	V
Side Ported (S)									
Heavy Spring (H)									
Other Rod Threads	Specify option N1, N2, or N3: #10-24 (N1) • M5x0.8 (N2) • #8-32 (N3)								
Threadless	N	N	N	N	N	N	N	N	N
Rotated Port Configurations <i>(See chart, p. 132)</i>	P6	P6			P6, 7, 8	P6, 7, 8	P2, 3, 4, 5, 6, 7, 8		P2

CYLINDERS

Need to replace a cylinder from another manufacturer? No problem.

- 1 Enter your cylinder part number into any search box on the **clippard.com** website.
- 2 The cylinder will appear in your search results, next to the **Interchange Guide** logo.
- 3 The **Interchange Guide** will display compatible Clippard cylinders.



clippard.com/link/interchange

STAINLESS STEEL

5/8" & 3/4" BORE CYLINDERS

BORE SIZE

5/8"

Base Part No.	USN-10	USR-10-	SSN-10-	SSR-10-	FSR-10-	FDR-10-	SDR-10-	UDR-10-	SDD-10-	SRR-10-	URR-10-
Cylinder Type	Single-Acting					Double-Acting				Reverse-Acting	
Mounting Style	Universal	Universal	Stud	Stud	Front Block	Front Block	Stud	Universal	Stud	Stud	Universal
Rod Type	Rotating	•		•	•	•	•	•	Double End	•	•
	Non-Rotating	•		•							
Maximum Stroke	23"	23"	23"	23"	13"	43"	43"	43"	20"	15"	14"
Standard Rod Threads	#10-32										
Options	Cushions (C, F, R)										
	Magnetic Piston (M)	M	M	M	M	M	M	M	M	M	M
	Bumpers (B)	B	B	B	B	B	B	B	B	B	B
	Wipers (W)		W		W	W	W	W	W	W	W
	FKM Seals (V)	V	V	V	V	V	V	V	V	V	V
	Side Ported (S)			S	S	S	S	S			
	Heavy Spring (H)	H	H	H	H	H				H	H
	Other Rod Threads	Specify option N1, N2, or N3: #10-24 (N1) • M5x0.8 (N2) • #8-32 (N3)									
	Threadless	N	N	N	N	N	N	N	N	N	N
Rotated Port Configurations <i>(See chart, p. 132)</i>	P6	P6				P6, 7, 8	P6, 7, 8	P2, 3, 4, 5, 6, 7, 8	P6, 7, 8		P2

Part Numbering Schematic



BORE SIZE

3/4" (Continued on next page)

Base Part No.	FSR-12-	SSN-12-	SSR-12-	TSR-12-	USN-12-	USR-12-	FDR-12-	TDR-12-	UDR-12-	SDR-12-	SDD-12-
Cylinder Type	Single-Acting						Double-Acting				
Mounting Style	Front Block	Stud	Stud	Trunnion	Universal	Universal	Front Block	Trunnion	Universal	Stud	Stud
Rod Type	Rotating	•	•	•		•	•	•	•	•	Double End
	Non-Rotating		•		•						
Maximum Stroke	25"	26"	26"	25"	25"	25"	42"	42"	41"	42"	20"
Standard Rod Threads	1/4-28										
Options	Cushions (C, F, R)								C, F, R	C, F, R	C, F, R
	Magnetic Piston (M)	M	M	M	M	M	M	M	M	M	M
	Bumpers (B)	B	B	B	B	B	B	B	B	B	B
	Wipers (W)		W			W	W	W	W	W	W
	FKM Seals (V)	V	V	V	V	V	V	V	V	V	V
	Side Ported (S)	S	S	S	S		S	S		S	
	Heavy Spring (H)	H	H	H	H	H					
	Large Rod										
	Other Rod Threads	Specify option N1, N2, or N3: 1/4-20 (N1) • M6x1.0 (N2) • #10-32 (N3)									
	Threadless	N	N	N	N	N	N	N	N	N	N
Rotated Port Configurations <i>(See chart, p. 132)</i>					P6	P6	P6, 7, 8	P6, 7, 8	P2, 3, 4, 5, 6, 7, 8	P6, 7, 8	P6, 7, 8

STAINLESS STEEL

3/4" & 7/8" BORE CYLINDERS

BORE SIZE

3/4" (Continued from previous page)

Base Part No.	SDH-12-	SRR-12-	URR-12-	SFD-12-	SBR-12-	SFR-12-	UBR-12-	UFR-12-	
Cylinder Type	Double-Acting	Reverse-Acting		Front Bias	Rear Bias	Front Bias	Rear Bias	Front Bias	
Mounting Style	Stud	Stud	Universal	Stud	Stud	Stud	Universal	Universal	
Rod Type	Rotating	Double (Hollow)	•	•	Double End	•	•	•	
	Non-Rotating								
Maximum Stroke	20"	16"	15"	15"	15"	25"	15"	24"	
Standard Rod Threads	1/4-28								
Cushions (C, F, R)	C, F								
Magnetic Piston (M)	M	M	M	M	M	M	M	M	
Bumpers (B)	B	B	B	B	B	B	B	B	
Options	Wipers (W)	W	W	W	W	W	W	W	
	FKM Seals (V)	V	V	V	V	V	V	V	
	Side Ported (S)					S	S		
	Heavy Spring (H)		H	H	H	H	H	H	
	Other Rod Threads	Specify option N1, N2, or N3: 1/4-20 (N1) • M6x1.0 (N2) • #10-32 (N3)							
	Threadless	N	N	N	N	N	N	N	N
	Rotated Port Configurations (See chart, p. 132)	P6, 7, 8		P2	P6, 7, 8	P6, 7, 8	P6, 7, 8	P2, 3, 4, 5, 6, 7, 8	P2, 3, 4, 5, 6, 7, 8

Part Numbering Schematic

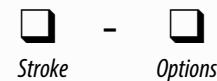

BORE SIZE

7/8"

Base Part No.	SSN-14-	SSR-14-	USN-14-	USR-14-	SDR-14-	SDD-14-	SDH-14-	UDR-14	SRR-14-	URR-14-	
Cylinder Type	Single-Acting				Double-Acting			Reverse-Acting			
Mounting Style	Stud		Universal		Stud		Universal	Stud	Universal		
Rod Type	Rotating	•	•	•	•	Double End	Double (Hollow)	•	•	•	
	Non-Rotating	•	•	•	•						
Maximum Stroke	27"	27"	27"	27"	42"	20"	20"	41"	16"	16"	
Standard Rod Threads	1/4-28										
Cushions (C, F, R)					C, F, R	C, F	C, F	C, F, R			
Magnetic Piston (M)	M	M	M	M	M	M	M	M	M	M	
Bumpers (B)	Standard										
Options	Wipers (W)	W	W	W	W	W	W	W	W	W	
	FKM Seals (V)	V	V	V	V	V	V	V	V	V	
	Side Ported (S)	S	S			S					
	Heavy Spring (H)	H	H	H	H				H	H	
	Large Rod										
	Other Rod Threads	Specify option N1, N2, or N3: 1/4-20 (N1) • M6x1.0 (N2) • #10-32 (N3)									
	Threadless	N	N	N	N	N	N	N	N	N	N
	Rotated Port Configurations (See chart, p. 132)			P6	P6	P6, 7, 8	P6, 7, 8	P6, 7, 8	P2, 3, 4, 5, 6, 7, 8		P2

STAINLESS STEEL

1-1/16" BORE CYLINDERS

BORE SIZE

1-1/16"

Base Part No.	SSN-17-	SSR-17-	USN-17-	USR-17-	FSR-17-	TSR-17-	SDR-17-	SDD-17-	SDH-17-	UDR-17-	FDR-17-	
Cylinder Type	Single-Acting						Double-Acting					
Mounting Style	Stud		Universal		Front Block	Trunnion	Stud			Universal	Front Block	
Rod Type	Rotating		•		•	•	•	Double End	Double (Hollow)		•	•
	Non-Rotating		•		•	•	•				•	•
Maximum Stroke	27"	27"	27"	27"	27"	26"	42"	20"	20"	41"	42"	
Standard Rod Threads	5/16-24											
	Cushions (C, F, R)						C, F, R	C, F, R	C, F, R	C, F, R		
Options	Magnetic Piston (M)	M	M	M	M	M	M	M	M	M	M	M
	Bumpers (B)	B	B	B	B	B	B	B	B	B	B	B
	Wipers (W)		W		W	W	W	W	W	W	W	W
	FKM Seals (V)	V	V	V	V	V	V	V	V	V	V	V
	Side Ported (S)	S	S			S	S	S				S
	Heavy Spring (H)	H	H	H	H	H	H					
	Large Rod											
Other Rod Threads	Specify option N1, N2, or N3: 5/16-18 (N1) • M8x1.25 (N2) • 1/4-28 (N3)											
	Threadless	N	N	N	N	N	N	N	N	N	N	N
Rotated Port Configurations <i>(See chart, p. 132)</i>			P6	P6			P6, 7, 8	P6, 7, 8	P6, 7, 8	P2, 3, 4, 5, 6, 7, 8	P6, 7, 8	

Part Numbering Schematic



BORE SIZE

1-1/16"

Base Part No.	TDR-17-	SRR-17-	URR-17-	SFD-17-	SFR-17-	UFR-17-	SBR-17-	UBR-17-	
Cylinder Type	Double-Acting		Reverse-Acting		Front Bias			Rear Bias	
Mounting Style	Trunnion		Stud	Universal	Stud		Universal	Stud	Universal
Rod Type	Rotating		•	•	•	Double End	•	•	•
	Non-Rotating								
Maximum Stroke	42"	16"	16"	15"	26"	26"	16"	16"	
Standard Rod Threads	5/16-24								
	Cushions (C, F, R)								
Options	Magnetic Piston (M)	M	M	M	M	M	M	M	
	Bumpers (B)	B	B	B	B	B	B	B	
	Wipers (W)	W	W	W	W	W	W	W	
	FKM Seals (V)	V	V	V	V	V	V	V	
	Side Ported (S)	S			S		S		
	Heavy Spring (H)		H	H	H	H	H	H	
	Large Rod								
Other Rod Threads	Specify option N1, N2, or N3: 5/16-18 (N1) • M8x1.25 (N2) • 1/4-28 (N3)								
	Threadless	N	N	N	N	N	N	N	
Rotated Port Configurations <i>(See chart, p. 132)</i>	P6, 7, 8		P2	P6, 7, 8	P6, 7, 8	P2, 3, 4, 5, 6, 7, 8	P6, 7, 8	P2, 3, 4, 5, 6, 7, 8	

STAINLESS STEEL

1-1/4" BORE CYLINDERS

BORE SIZE

1-1/4"

Base Part No.	SSN-20-	SSR-20-	USN-20-	USR-20-	SDD-20-	SDR-20-	UDR-20-	SRR-20-	URR-20-	SFR-20	UFR-20	SBR-20	UBR-20	
Cylinder Type	Single-Acting				Double-Acting			Reverse-Acting		Front Bias		Rear Bias		
Mounting Style	Stud		Universal		Stud		Universal	Stud	Universal	Stud	Universal	Stud	Universal	
Rod Type	Rotating		•		•	Double End	•	•	•	•	•	•	•	
	Non-Rotating	•		•										
Maximum Stroke	23"	23"	22"	22"	19"	41"	40"	14"	14"	22"	21"	16"	15"	
Standard Rod Threads	3/8-24													
Options	Cushions (C, F, R)					C, F	C, F, R	C, F, R						
	Magnetic Piston (M)	M	M	M	M	M	M	M	M	M	M	M	M	
	Bumpers (B)	B	B	B	B	B	B	B	B	B	B	B	B	
	Wipers (W)					W	W	W	W	W	W			
	FKM Seals (V)	V	V	V	V	V	V	V	V	V	V	V	V	
	Side Ported (S)	S	S				S				S			
	Heavy Spring (H)	H	H	H	H				H	H	H	H	H	
	Large Rod (LR)	LR	LR	LR	LR	LR	LR	LR	LR	LR				
	Other Rod Threads	Specify option N1, N2, or N3: 3/8-16 (N1) • M8x1.25 (N2) • 5/16-24 (N3)												
	Threadless	N	N	N	N	N	N	N	N	N	N	N	N	N
Rotated Port Configurations <i>(See chart, p. 132)</i>			P6	P6	P6, 7, 8	P6, 7, 8	P2, 3, 4, 5, 6, 7, 8		P2					

CYLINDERS

Need to replace a cylinder from another manufacturer? No problem.

- 1 Enter your cylinder part number into any search box on the **clippard.com** website.
- 2 The cylinder will appear in your search results, next to the **Interchange Guide** logo.
- 3 The **Interchange Guide** will display compatible Clippard cylinders.



clippard.com/link/interchange

STAINLESS STEEL

1-1/2" BORE CYLINDERS

BORE SIZE

1-1/2"

Base Part No.	CSN-24-	CSR-24-	ESN-24-	ESR-24-	FSR-24-	SSN-24-	SSR-24-	TSR-24-	CDR-24-
Cylinder Type	Single-Acting								Double-Acting
Mounting Style	Clevis	Clevis	End Stud	End Stud	Front Block	Stud	Stud	Trunnion	Clevis
Rod Type	Rotating	•		•	•		•	•	•
	Non-Rotating	•		•		•			
Maximum Stroke	24"	24"	24"	15"	24"	24"	24"	23"	39"
Standard Rod Threads	7/16-20								
Options	Cushions (C, F, R)								C, F, R
	Magnetic Piston (M)	M	M	M	M	M	M	M	M
	Bumpers (B)	M	B	B	B	B	B	B	B
	Wipers (W)		W		W	W		W	W
	FKM Seals (V)	V	V	V	V	V	V	V	V
	Side Ported (S)					S	S	S	S
	Heavy Spring (H)	H	H	H	H	H	H	H	H
	Other Rod Threads	Specify option N1, N2, or N3: 7/16-14 (N1) • M10x1.5 (N2) • 3/8-24 (N3)							
Threadless	N	N	N	N	N	N	N	N	N
Rotated Port Configurations <i>(See chart, p. 132)</i>	P6	P6							P2, 3, 4, 5, 6, 7, 8

Part Numbering Schematic



BORE SIZE

1-1/2" (Continued on next page)

Base Part No.	EDR-24-	FDR-24-	SDR-24-	TDR-24-	SDD-24-	CRR-24-	ERR-24-	FRR-24-	
Cylinder Type	Double-Acting					Reverse-Acting			
Mounting Style	End Stud	Front Block	Stud	Trunnion	Stud	Clevis	End Stud	Front Block	
Rod Type	Rotating	•	•	•	•	Double End	•	•	•
	Non-Rotating								
Maximum Stroke	39"	40"	40"	40"	19"	14"	14"	15"	
Standard Rod Threads	7/16-20								
Options	Cushions (C, F, R)	C, F, R		C, F, R		C, F			
	Magnetic Piston (M)	M	M	M	M	M	M	M	
	Bumpers (B)	B	B	B	B	B	B	B	
	Wipers (W)	W	W	W	W	W	W	W	
	FKM Seals (V)	V	V	V	V	V	V	V	
	Side Ported (S)		S	S					
	Heavy Spring (H)						H	H	H
	Other Rod Threads	Specify option N1, N2, or N3: 7/16-14 (N1) • M10x1.5 (N2) • 3/8-24 (N3)							
Threadless	N	N	N	N	N	N	N	N	
Rotated Port Configurations <i>(See chart, p. 132)</i>	P6, 7, 8	P6, 7, 8	P6, 7, 8	P6, 7, 8	P6, 7, 8	P2, 3, 4, 5, 6, 7, 8			

STAINLESS STEEL

1-1/2" & 1-3/4" BORE CYLINDERS

BORE SIZE

1-1/2" (Continued from previous page)

Base Part No.	SRR-24-	CBR-24-	CFR-24-	EBR-24-	EFR-24-	SFD-24-	SBR-24-	SFR-24-
Cylinder Type	Reverse-Acting	Rear Bias	Front Bias	Rear Bias	Front Bias	Front Bias	Rear Bias	Front Bias
Mounting Style	Stud	Clevis	Clevis	End Stud	End Stud	Stud	Stud	Stud
Rod Type	Rotating	•	•	•	•	•	Double End	•
	Non-Rotating							
Maximum Stroke	15"	14"	23"	14"	23"	14"	15"	23"
Standard Rod Threads	7/16-20							
Cushions (C, F, R)								
Magnetic Piston (M)	M	M	M	M	M	M	M	M
Bumpers (B)	B	B	B	B	B	B	B	B
Options	Wipers (W)	W	W	W	W	W	W	W
	FKM Seals (V)	V	V	V	V	V	V	V
Side Ported (S)							S	S
Heavy Spring (H)	H	H	H	H	H	H	H	H
Other Rod Threads	Specify option N1, N2, or N3: 7/16-14 (N1) • M10x1.5 (N2) • 3/8-24 (N3)							
Threadless	N	N	N	N	N	N	N	N
Rotated Port Configurations (See chart, p. 132)		P2, 3, 4, 5, 6, 7, 8	P2, 3, 4, 5, 6, 7, 8	P6, 7, 8	P6, 7, 8	P6, 7, 8	P6, 7, 8	P6, 7, 8

Part Numbering Schematic



BORE SIZE

1-3/4"

Base Part No.	SSN-28-	SSR-28-	USN-28-	USR-28-	SDR-28-	UDR-28-	SDD-28-	SRR-28-	URR-28-
Cylinder Type	Single-Acting				Double-Acting			Reverse-Acting	
Mounting Style	Stud	Stud	Universal	Universal	Stud	Universal	Stud	Stud	Universal
Rod Type	Rotating	•	•	•	•	•	Double End	•	•
	Non-Rotating	•	•	•	•	•			
Maximum Stroke	20"	20"	19"	19"	39"	37"	18"	13"	12"
Standard Rod Threads	1/2-20								
Cushions (C, F, R)					C, F, R	C, F, R	C, F		
Magnetic Piston (M)	M	M	M	M	M	M	M	M	M
Bumpers (B)	Standard								
Options	Wipers (W)	W	W	W	W	W	W	W	W
	FKM Seals (V)	V	V	V	V	V	V	V	V
Side Ported (S)	S	S			S				
Heavy Spring (H)									
Other Rod Threads	Specify option N1, N2, or N3: 1/2-13 (N1) • M12x1.5 (N2) • 7/16-20 (N3)								
Threadless	N	N	N	N	N	N	N	N	N
Rotated Port Configurations (See chart, p. 132)			P6	P6	P6, 7, 8	P2, 3, 4, 5, 6, 7, 8	P6, 7, 8		P2

STAINLESS STEEL

2" BORE CYLINDERS

BORE SIZE 2"

Base Part No.	SSR-32-	USR-32-	SDR-32-	UDR-32-	SDD-32-
Cylinder Type	Single-Acting		Double-Acting		
Mounting Style	Stud	Universal	Stud	Universal	Stud
Rod Type	Rotating	•	•	•	Double End
	Non-Rotating				
Maximum Stroke	20"	19"	39"	38"	18"
Standard Rod Threads	1/2-20				
Cushions (C, F, R)			C, F, R	C, F, R	C, F
Magnetic Piston (M)	M	M	M	M	M
Bumpers (B)	B	B	B	B	B
Options	Wipers (W)	W	W	W	W
	FKM Seals (V)	V	V	V	V
Side Ported (S)	S		S		
Heavy Spring (H)					
Other Rod Threads	Specify option N1, N2, or N3: 1/2-13 (N1) • M12x1.5 (N2) • 7/16-20 (N3) • 5/8-18 (N4)				
Threadless	N	N	N	N	N
Rotated Port Configurations <i>(See chart, p. 132)</i>		P6	P6, 7, 8	P2, 3, 4, 5, 6, 7, 8	P6, 7, 8

Part Numbering Schematic



BORE SIZE 2"

Base Part No.	SRR-32-	URR-32-	SFR-32-	SBR-32-	UFR-32-	UBR-32-
Cylinder Type	Reverse-Acting		Front Bias	Rear Bias	Front Bias	Rear Bias
Mounting Style	Stud	Universal	Stud	Stud	Universal	Universal
Rod Type	Rotating	•	•	•	•	•
	Non-Rotating					
Maximum Stroke	12"	13"	19"	13"	18"	12"
Standard Rod Threads	1/2-20					
Cushions (C, F, R)						
Magnetic Piston (M)	M	M	M	M	M	M
Bumpers (B)	B	B	B	B	B	B
Options	Wipers (W)	W	W	W	W	W
	FKM Seals (V)	V	V	V	V	V
Side Ported (S)			S	S		
Heavy Spring (H)						
Other Rod Threads	Specify option N1, N2, or N3: 1/2-13 (N1) • M12x1.5 (N2) • 7/16-20 (N3) • 5/8-18 (N4)					
Threadless	N	N	N	N	N	N
Rotated Port Configurations <i>(See chart, p. 132)</i>		P2	P6, 7, 8	P6, 7, 8	P2, 3, 4, 5, 6, 7, 8	P2, 3, 4, 5, 6, 7, 8

STAINLESS STEEL

2-1/2" & 3" BORE CYLINDERS

BORE SIZE

2-1/2"

3"

Base Part No.	SDR-40-	UDR-40-	SDD-40-	SDR-48-	UDR-48-	SDD-48-
Cylinder Type	Double-Acting			Double-Acting		
Mounting Style	Stud	Universal	Stud	Stud	Universal	Stud
Rod Type	Rotating •	•	Double End	•	•	Double End
	Non-Rotating					
Maximum Stroke	39"	38"	18"	34"	32"	15"
Standard Rod Threads	1/2-20			5/8-18		
Options	Cushions (C, F, R) C, F, R	C, F, R	C, F			
	Magnetic Piston (M) M	M	M	M	M	M
	Bumpers (B) Standard	Standard		Standard		
	Wipers (W) W	W	W	W	W	W
	FKM Seals (V) V	V	V	V	V	V
	Side Ported (S) S			S		
	Other Rod Threads Specify option N1, N2, or N3: 1/2-13 (N1) • M12x1.5 (N2) • 7/16-20 (N3) • 5/8-18 (N4)	Specify option N1, N2, or N3: 5/8-11 (N1) • M16x1.5 (N2) • 1/2-20 (N3) • 3/4-16 (N4)				
	Threadless N	N	N	N	N	N
Rotated Port Configurations <i>(See chart, p. 132)</i>	P6, 7, 8	P2, 3, 4, 5, 6, 7, 8	P6, 7, 8	P6, 7, 8	P2, 3, 4, 5, 6, 7, 8	P6, 7, 8

Part Numbering Schematic



Need to replace a cylinder from another manufacturer? No problem.

- 1 Enter your cylinder part number into any search box on the **clippard.com** website.
- 2 The cylinder will appear in your search results, next to the **Interchange Guide** logo.
- 3 The **Interchange Guide** will display compatible Clippard cylinders.



clippard.com/link/interchange

All Stainless Steel

Designed for use in a broad range of applications including those in washdown and caustic environments, these high quality cylinders are constructed of durable 303 and 304 stainless steel. They include a nitrile rod wiper to keep potential contaminants from penetrating inside the cylinder, and are available in bore sizes from 3/4" to 2". Standard stroke lengths are from 1" up to 32" on some models.

- Ideal for harsh, caustic environments
- High quality, precision rolled construction
- Constructed of durable 303 & 304 stainless steel
- Low maintenance, durable design
- Low breakaway forces provide long life
- Wide variety of interchangeable mounting styles
- Bore sizes from 3/4" up to 2"
- Nitrile rod wipers
- FDA compliant grease
- Magnetic pistons available

Bore Size	3/4" up to 2"
Cylinder Type	Double-Acting
Lubrication	FDA compliant grease standard, Magnalube® available
Material, Bushing	FDA compliant Rulon®
Material, End Caps	303 Stainless steel
Material, Rod	303 Stainless steel
Material, Seal	Nitrile standard, FKM available
Material, Tube	304 Stainless steel
Mounting Style	Stud, universal, clevis, or end
Pressure, Max.	250 psig
Rod Type	Rotating or double end
Rod Wipers	Included (nitrile)
Temperature	-20 to 230°F (-20 to 400°F with FKM)
More Info	clippard.com/link/cyl-allss

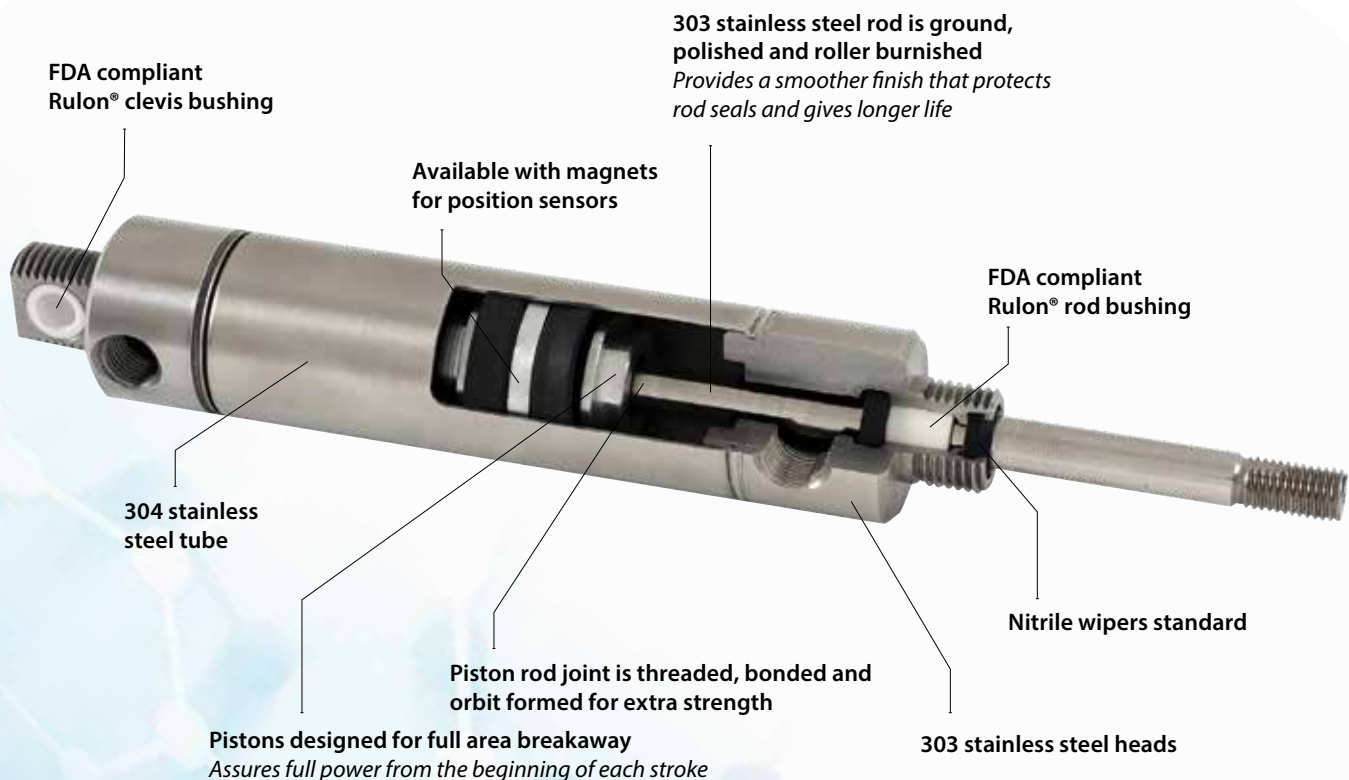

Mounting Options



Stud, Front (S)



Universal (U)



Clevis (C)



Stud, End (E)

ORDERING INFORMATION

Please Note: Not all possible configurations shown below are available. Please reference the charts on the preceding pages for complete details or visit clippard.com/link/cyl-allss to use our online configurator.

After selecting a cylinder from one of the charts, simply add your **stroke** and **options** to the end of the **base part number** listed in the chart. This will provide the complete part number for your cylinder.

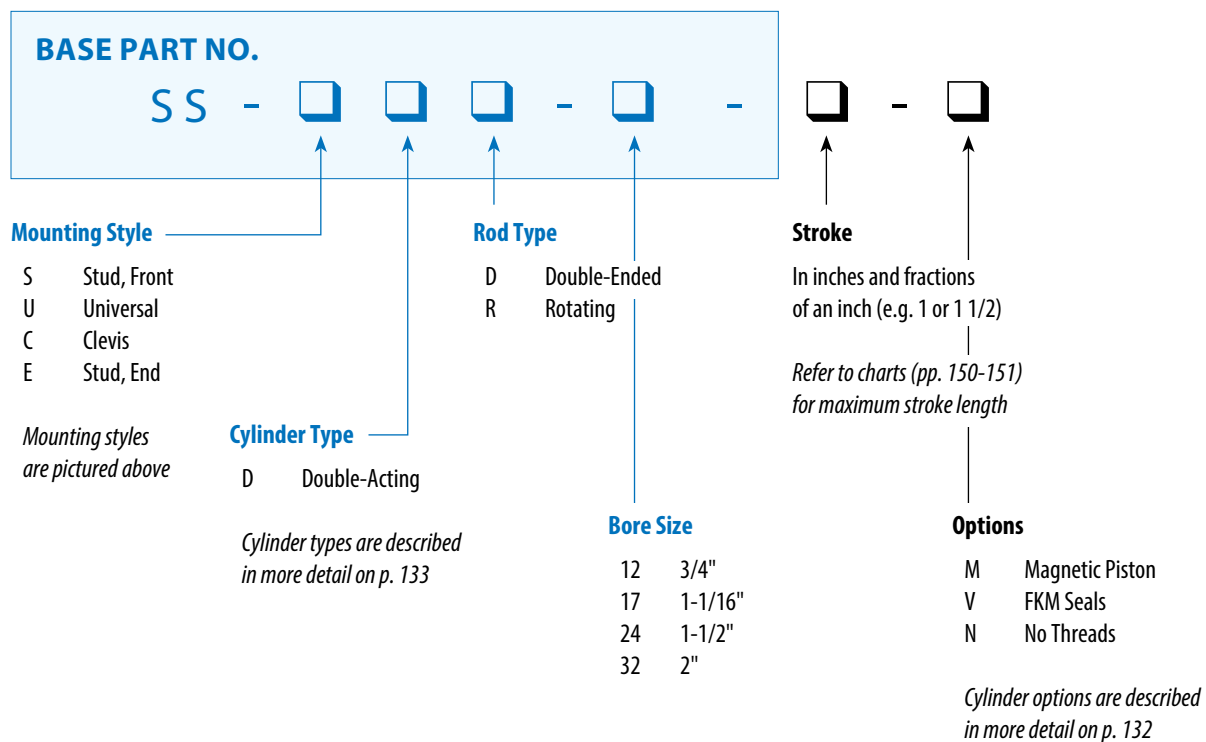

ALL STAINLESS

3/4", 1-1/16", 1-1/2" & 2" BORE CYLINDERS

BORE SIZE

3/4"

1-1/16"

Base Part No.	SS-SDR-12-	SS-UDR-12-	SS-UDD-12-	SS-SDR-17-	SS-UDR-17-	SS-SDD-17-
Cylinder Type	Double-Acting			Double-Acting		
Mounting Style	Stud	Universal	Universal	Stud	Universal	Stud
Rod Type	Rotating	•	•	•	•	Double End
	Non-Rotating					
Maximum Stroke	12"	32"	6"	12"	24"	6"
Standard Rod Threads	1/4-28			5/16-24		
Options						
Cushions (C, F, R)						
Magnetic Piston (M)	M	M	M	M	M	M
Bumpers (B)						
Wipers (W)						
FKM Seals (V)	V	V	V	V	V	V
PTFE Grease (TG)	TG	TG	TG	TG	TG	TG
Other Rod Threads (N1, N2, N3)	1/4-20 (N1) M6x1.0 (N2) #10-32 (N3)	1/4-20 (N1) M6x1.0 (N2) #10-32 (N3)	1/4-20 (N1) M6x1.0 (N2) #10-32 (N3)	5/16-18 (N1) M8x1.25 (N2) 1/4-28 (N3)	5/16-18 (N1) M8x1.25 (N2) 1/4-28 (N3)	5/16-18 (N1) M8x1.25 (N2) 1/4-28 (N3)
Threadless	N	N	N	N	N	N
Rotated Port Configurations <i>(See chart, p. 132)</i>						

Part Numbering Schematic

SS - - -
Base Part No.

-
Stroke Options

ALL STAINLESS

3/4", 1-1/16", 1-1/2" & 2" BORE CYLINDERS

BORE SIZE

1-1/2"

2"

Base Part No.	SS-SDR-24-	SS-CDR-24-	SS-SDD-24-	SS-EDR-24-	SS-SDR-32-	SS-UDR-32-	SS-SDD-32-
Cylinder Type	Double-Acting				Double-Acting		
Mounting Style	Stud	Clevis	Stud	End Stud	Stud	Universal	Stud
Rod Type	Rotating	•	•	Double End	•	•	Double End
	Non-Rotating						
Maximum Stroke	12"	32"	19"	39"	12"	32"	12"
Rod Threads	7/16-20				1/2-20		
Options							
Cushions (C, F, R)							
Magnetic Piston (M)	M	M	M	M	M	M	M
Bumpers (B)							
Wipers (W)							
FKM Seals (V)	V	V	V	V	V	V	V
PTFE Grease (TG)	TG	TG	TG	TG	TG	TG	TG
Other Rod Threads (N1, N2, N3)	7/16-14 (N1) M10x1.5 (N2) 3/8-24 (N3)	7/16-14 (N1) M10x1.5 (N2) 3/8-24 (N3)	7/16-14 (N1) M10x1.5 (N2) 3/8-24 (N3)	7/16-14 (N1) M10x1.5 (N2) 3/8-24 (N3)	1/2-13 (N1) M12x1.5 (N2) 7/16-20 (N3)	1/2-13 (N1) M12x1.5 (N2) 7/16-20 (N3)	1/2-13 (N1) M12x1.5 (N2) 7/16-20 (N3)
Threadless	N	N	N	N	N	N	N
Rotated Port Configurations (See chart, p. 132)							

Part Numbering Schematic

SS - □ □ □ - □ -
Base Part No.

□ - □
Stroke Options

CYLINDERS

Corrosion-Resistant

This line of corrosion-resistant cylinders provides the same advantages of Clippard's superior quality stainless steel cylinders along with the added benefit of corrosion resistance. Featuring acetal heads with double positive seals, these cylinders are designed for harsh environments requiring frequent use of hot water and chemicals. They are ideal for applications where equipment cleanliness is critical.

- Acetal heads with positive double seals
- Designed for harsh environments requiring frequent use of hot water and chemicals
- High quality, precision rolled construction
- Low maintenance, durable design
- Bore sizes from 5/8" up to 1-1/2"
- Magnetic pistons available
- Ideal for applications where equipment cleanliness is critical
- Aluminum alloy pistons (acetal available)

Bore Size	5/8" up to 1 1/2"
Cylinder Type	Double-Acting
Material, End Caps	Acetal
Material, Rod	303 Stainless steel
Material, Seal	Nitrile standard (FKM available)
Material, Tube	304 Stainless steel
Mounting Style	Stud or universal
Pressure, Max.	150 psig
Rod Type	Rotating or double end
Temperature	32 to 180°F
More Info	clippard.com/link/cyl-cr

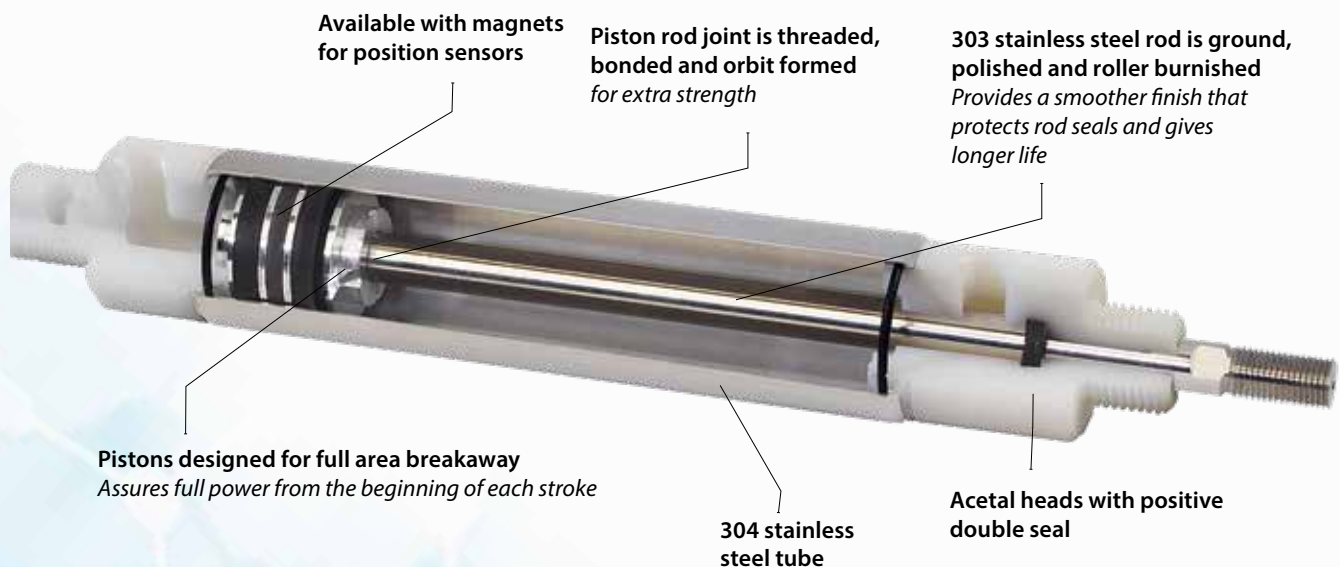

Mounting Options



Stud, Front (S)



Universal (U)

ORDERING INFORMATION

Please Note: Not all possible configurations shown below are available. Please reference the charts on the preceding pages for complete details or visit clippard.com/link/cyl-cr to use our online configurator.

After selecting a cylinder from one of the charts, simply add your **stroke** and **options** to the end of the **base part number** listed in the chart. This will provide the complete part number for your cylinder.

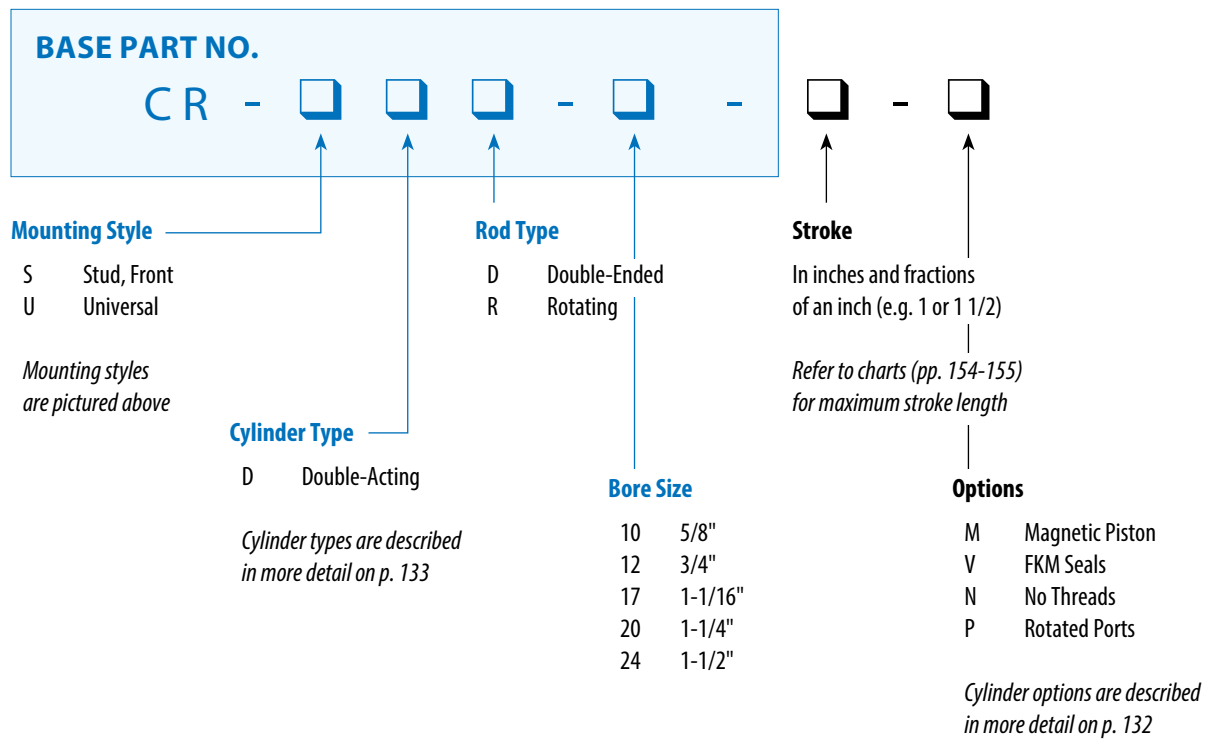

CORROSION-RESISTANT

5/8", 3/4" & 1-1/16" BORE CYLINDERS

BORE SIZE

5/8"

3/4"

1-1/16"

Base Part No.	CR-SDD-10-	CR-SDR-10-	CR-UDR-10-	CR-SDD-12-	CR-SDR-12-	CR-UDR-12-	CR-SDD-17-	CR-SDR-17-	CR-UDR-17-	
Cylinder Type	Double-Acting			Double-Acting			Double-Acting			
Mounting Style	Stud	Stud	Universal	Stud	Stud	Universal	Stud	Stud	Universal	
Rod Type	Rotating	Double End	•	•	Double End	•	•	Double End	•	•
	Non-Rotating									
Maximum Stroke	20"	43"	43"	20"	42"	41"	20"	42"	41"	
Standard Rod Threads	#10-32			1/4-28			5/16-24			
Options	Cushions (C, F, R) Magnetic Piston Bumpers Wipers FKM Seals PTFE Grease Other Rod Threads (N1, N2, N3) Threadless									
	M	M	M	M	M	M	M	M	M	
	V	V	V	V	V	V	V	V	V	
	#10-24 (N1) M5x0.8 (N2) #8-32 (N3)	#10-24 (N1) M5x0.8 (N2) #8-32 (N3)	#10-24 (N1) M5x0.8 (N2) #8-32 (N3)	1/4-20 (N1) M6x1.0 (N2) #10-32 (N3)	1/4-20 (N1) M6x1.0 (N2) #10-32 (N3)	1/4-20 (N1) M6x1.0 (N2) #10-32 (N3)	5/16-18 (N1) M8x1.25 (N2) 1/4-28 (N3)	5/16-18 (N1) M8x1.25 (N2) 1/4-28 (N3)	5/16-18 (N1) M8x1.25 (N2) 1/4-28 (N3)	
	N	N	N	N	N	N	N	N	N	
Rotated Port Configurations <i>(See chart, p. 132)</i>	P2, 3, 4, 5, 6, 7, 8		P2, 3, 4, 5, 6, 7, 8	P2, 3, 4, 5, 6, 7, 8	P6, 7, 8	P2, 3, 4, 5, 6, 7, 8	P6, 7, 8		P2, 3, 4, 5, 6, 7, 8	

Part Numbering Schematic

CR-□□□-□□-
Base Part No.

□ - □
Stroke Options

CORROSION-RESISTANT

1-1/4" & 1-1/2" BORE CYLINDERS

BORE SIZE

1-1/4"

1-1/2"

Base Part No.	CR-SDD-20-	CR-SDR-20-	CR-UDR-20-	CR-SDD-24-	CR-SDR-24-	CR-UDR-24-
Cylinder Type	Double-Acting			Double-Acting		
Mounting Style	Stud	Stud	Universal	Stud	Stud	Universal
Rod Type	Rotating	Double End	•	•	Double End	•
	Non-Rotating					
Maximum Stroke	19"	41"	40"	19"	14"	
Standard Rod Threads	3/8-24			7/16-20		
Options						
Cushions (C, F, R)						
Magnetic Piston (M)	M	M	M	M	M	M
Bumpers (B)						
Wipers (W)						
FKM Seals (V)	V	V	V	V	V	V
PTFE Grease (TG)						
Other Rod Threads (N1, N2, N3)	3/8-16 (N1) M8x1.25 (N2) 5/16-24 (N3)	3/8-16 (N1) M8x1.25 (N2) 5/16-24 (N3)	3/8-16 (N1) M8x1.25 (N2) 5/16-24 (N3)	7/16-14 (N1) M10x1.5 (N2) 3/8-24 (N3)	7/16-14 (N1) M10x1.5 (N2) 3/8-24 (N3)	7/16-14 (N1) M10x1.5 (N2) 3/8-24 (N3)
Threadless (N)	N	N	N	N	N	N
Rotated Port Configurations <i>(See chart, p. 132)</i>	P6, 7, 8		P2, 3, 4, 5, 6, 7, 8	P6, 7, 8		P2, 3, 4, 5, 6, 7, 8

Part Numbering Schematic

CR-□□□-□□-

Base Part No.

□ -

Stroke

□

Options

Compact Extruded

Clippard's line of extruded body cylinders are compact, lightweight, and reliable. The standard, interchangeable design and large variety of mounting styles, bore sizes, and available options make this one of the most versatile cylinder lines in the world. This versatility, in combination with Clippard's superior service, fast delivery, and easy-to-use online cylinder interchange guide, helps prevent down time by enabling quick drop-in replacements.

- Available in 7 bore sizes
- Superior service and quick delivery
- Choose from metric or imperial ports
- Multiple mounting options
- Optional GMR sensor slides into groove for low profile mounting
- Custom strokes welcomed
- Interchangeable design allows for quick, drop-in replacements

Bore Size	12 mm, 16 mm, 20 mm, 25 mm, 32 mm, 40 mm, and 50 mm
Cylinder Type	Double-Acting; Single-Acting, Spring Return; or Reverse-Acting, Spring Extended
Magnetic Piston	Available
Material, Rod	303 Stainless steel, chrome-plated
Material, Seal	Nitrile
Material, Body	Aluminum, clear anodized
Mounting Style	Threaded or thru holes
Pressure, Max.	14 to 145 psig (10 bar)
Rod Type	Rotating or double end
Rod Wipers/Seals	Polyurethane
Standard Stroke	From 1/8" up to 4" (5 to 100 mm)
Temperature	-4° to 158°F
More Info	clippard.com/link/cyl-extruded

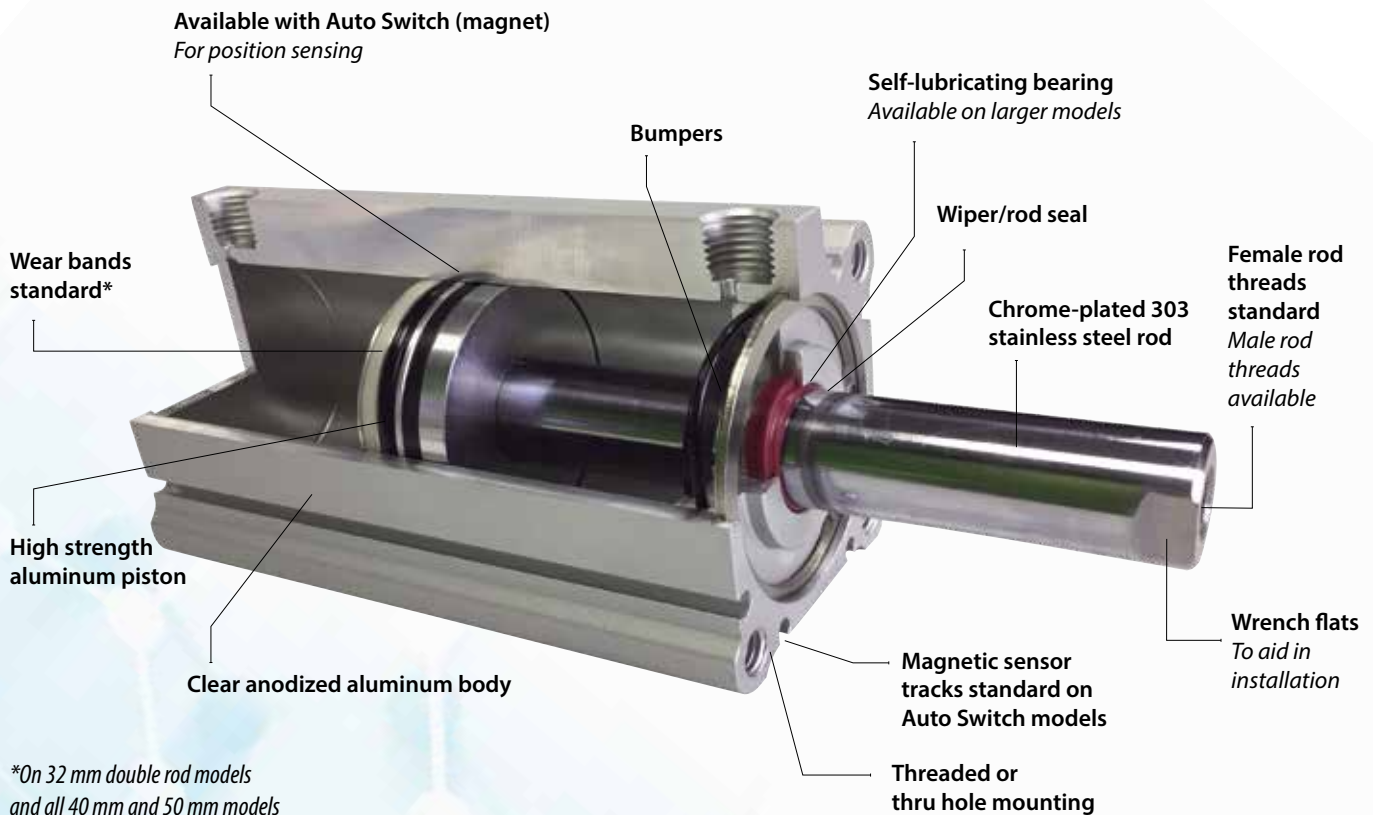

**On 32 mm double rod models and all 40 mm and 50 mm models*

Mounting Options



**Threaded,
Both Ends (A)**



Thru Hole (B)

ORDERING INFORMATION

Please Note: Not all possible configurations shown below are available. Please reference the charts on the preceding pages for complete details or visit clippard.com/link/cyl-extruded to use our online configurator.

After selecting a cylinder from one of the charts, add your **bore size**, **stroke**, and **options** to the end of the **base part number** listed in the chart. This will provide the complete part number for your cylinder.

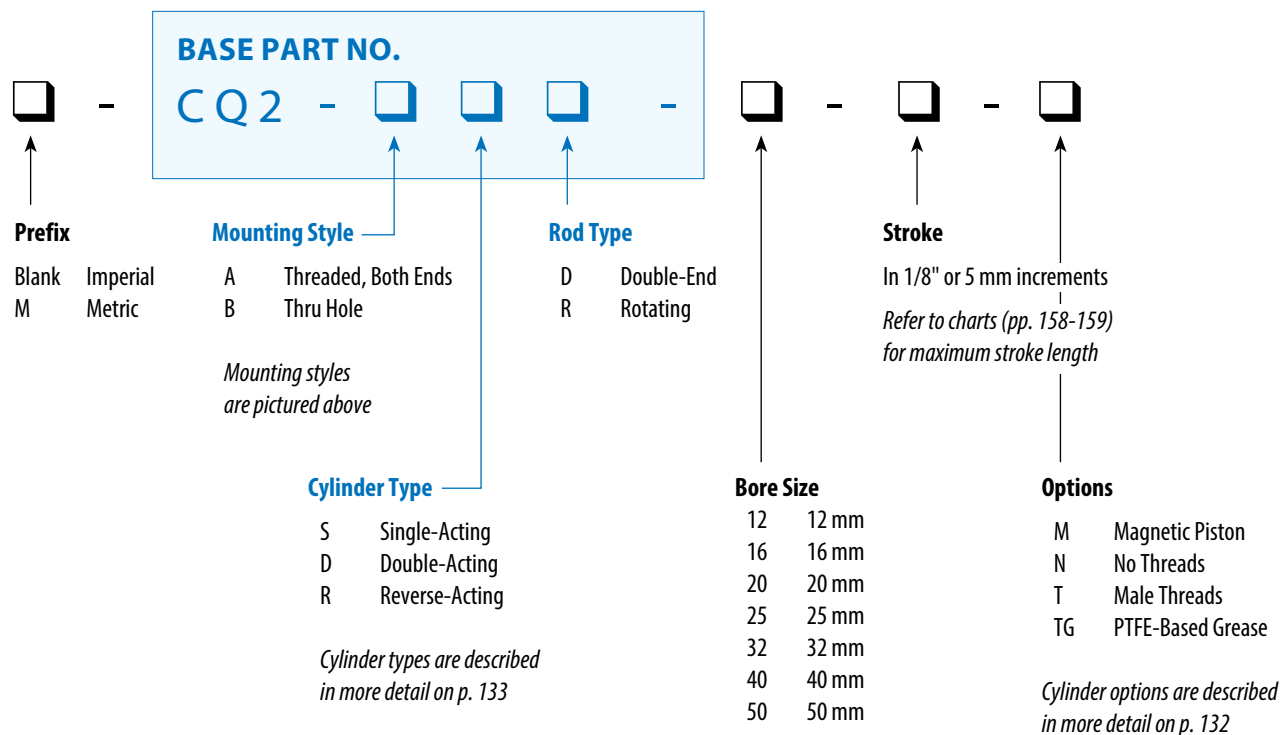

COMPACT EXTRUDED

12, 16, 20 & 25 MM BORE CYLINDERS

BORE SIZE 12 mm & 16 mm

Base Part No.	CQ2-ADR-	CQ2-BDR-	CQ2-ASR-	CQ2-BSR-	CQ2-ARR-	CQ2-BRR-	CQ2-ADD-	CQ2-BDD-
Cylinder Type	Double-Acting		Single-Acting		Reverse-Acting		Double-Acting	
Mounting Style	Threaded	Thru Hole	Threaded	Thru Hole	Threaded	Thru Hole	Threaded	Thru Hole
Rod Type	Rotating	•	•	•	•	•	Double End	Double End
	Non-Rotating							
Maximum Stroke	30 mm (1")	30 mm (1")	20 mm (3/4")	20 mm (3/4")	20 mm (3/4")	20 mm (3/4")	30 mm (1")	30 mm (1")
Options	Magnetic Piston (M)	M	M	M	M	M	M	M
	Threadless (N)	N	N	N	N	N	N	N
	Male Threads (T)	T	T	T	T	T	T	T
	PTFE Grease (TG)	TG	TG	TG	TG	TG	TG	TG

Metric Threads All compact extruded cylinders are also available with **metric threads** (add M- prefix to part number)

Part Numbering Schematic



BORE SIZE 20 mm & 25 mm

Base Part No.	CQ2-ADR-	CQ2-BDR-	CQ2-ASR-	CQ2-BSR-	CQ2-ARR-	CQ2-BRR-	CQ2-ADD-	CQ2-BDD-
Cylinder Type	Double-Acting		Single-Acting		Reverse-Acting		Double-Acting	
Mounting Style	Threaded	Thru Hole	Threaded	Thru Hole	Threaded	Thru Hole	Threaded	Thru Hole
Rod Type	Rotating	•	•	•	•	•	Double End	Double End
	Non-Rotating							
Maximum Stroke	50 mm (2")	50 mm (2")	30 mm (1")	30 mm (1")	30 mm (1")	30 mm (1")	50 mm (2")	50 mm (2")
Options	Magnetic Piston (M)	M	M	M	M	M	M	M
	Threadless (N)	N	N	N	N	N	N	N
	Male Threads (T)	T	T	T	T	T	T	T
	PTFE Grease (TG)	TG	TG	TG	TG	TG	TG	TG

Metric Threads All compact extruded cylinders are also available with **metric threads** (add M- prefix to part number)

Part Numbering Schematic



COMPACT EXTRUDED

32, 40 & 50 MM BORE CYLINDERS

BORE SIZE 32 mm, 40 mm & 50 mm

Base Part No.	CQ2-ADR-	CQ2-BDR-	CQ2-ASR-	CQ2-BSR-	CQ2-ARR-	CQ2-BRR-	CQ2-ADD-	CQ2-BDD-
Cylinder Type	Double-Acting		Single-Acting		Reverse-Acting		Double-Acting	
Mounting Style	Threaded	Thru Hole	Threaded	Thru Hole	Threaded	Thru Hole	Threaded	Thru Hole
Rod Type	Rotating	•	•	•	•	•	Double End	Double End
	Non-Rotating							
Maximum Stroke	100 mm (4")	100 mm (4")	30 mm (1")	30 mm (1")	30 mm (1")	30 mm (1")	100 mm (4")	100 mm (4")
Options	Magnetic Piston (M)	M	M	M	M	M	M	M
	Threadless (N)	N	N	N	N	N	N	N
	Male Threads (T)	T	T	T	T	T	T	T
	PTFE Grease (TG)	TG	TG	TG	TG	TG	TG	TG

Metric Threads All compact extruded cylinders are also available with **metric threads** (add M- prefix to part number)

Part Numbering Schematic



Need to replace a cylinder from another manufacturer? No problem.

- 1 Enter your cylinder part number into any search box on the **clippard.com** website.
- 2 The cylinder will appear in your search results, next to the **Interchange Guide** logo.
- 3 The **Interchange Guide** will display compatible Clippard cylinders.



clippard.com/link/interchange

Brass Cylinders

- The **original** miniature pneumatic cylinder
- Rods threaded and bonded to piston
- Nitrile u-cup seals provide smooth, leakproof operation
- Compact, robust design



Bore Size	5/32", 1/4", 3/8", 9/16", 7/8"
Cylinder Type	Single-Acting, Double-Acting
Material, End Caps	Brass and stainless steel
Material, Rod	Stainless steel or brass
Material, Seal	Nitrile
Material, Tube	Brass and stainless steel
Mounting Style	Body, stud, clevis, universal, or body
Pressure, Max.	Varies up to 250 psig
Rod Type	Double end, rotating, non-rotating
Standard Strokes	1/4" up to 6"
Temperature	30 to 180°F
More Info	clippard.com/link/cyl-brass



Mounting Options



Body (P)

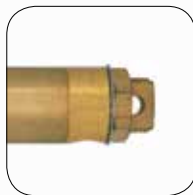

Universal (U)



Clevis (C)



Stud (S)

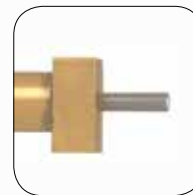

Block (B)

ORDERING INFORMATION

BASE PART NO.

Consult charts (pp. 161-162)

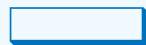

Example Part Number: **MMF-4Z-DM**



Options

- N Threadless
- T Male Threads

Stroke

Inches and fractions
of an inch

Mounting Options	Cylinder Type	Rod Type	Bore Size
P Body	Single-Acting	D Double-Ended	5/32"
U Universal	Double-Acting	N Non-Rotating	1/4"
C Clevis	Reverse-Acting	R Rotating	3/8"
S Stud			9/16"
B Block			7/8"

BRASS

5/32", 1/4", 3/8" & 9/16" BORE CYLINDERS

BORE SIZE

5/32" 1/4" 3/8"

*Stainless steel

Base Part No.		SM-2*	SM-3*	SM-6	3SS-AR-	3PS-	3SS-	3CS-	3BDS-	3BDD-	3SD-	3CD-
Cylinder Type		Single-Acting		Single-Acting	Reverse-Acting	Single-Acting			Double-Acting			
Mounting Style		Stud	Stud	Body	Stud	Body	Stud	Clevis	Block		Stud	Clevis
Rod Type	Rotating	•	•	•	•		•	•	•	Double End	•	•
	Non-Rotating					•						
Available Stroke Lengths	1/4"	•	•									
	3/8"			•								
	1/2"		•		•	•	•	•				
	3/4"		•									
	1"		•				•	•	•	•	•	•
	2"						•	•	•	•	•	•
	3"						•	•	•	•	•	•
	4"								•	•	•	•
5"								•				
6"								•				
Options	Threadless (N)				N							
	Male Threads (T)						T	T	T	T	T	T

Part Numbering Schematic



-



-



BORE SIZE

9/16" (Continued on next page)

Base Part No.		9PS-	9BS-	9SS-	9CS-	9BDS-	9BDD-	9SD-	9CD-
Cylinder Type		Single-Acting				Double-Acting			
Mounting Style		Body	Block	Stud	Clevis	Block		Stud	Clevis
Rod Type	Rotating		•	•	•	•	Double End	•	•
	Non-Rotating	•							
Available Stroke Lengths	3/4"	•	•	Non-Rotating	•				
	1"					•	•	•	•
	1-1/2"		•	•	•				
	2"		2-1/4"	2-1/4"	2-1/4"	•	•	•	•
	3"		•	•	•	•	•	•	•
	4"					•	•	•	•
	5"					•	•	•	•
	6"					•	•	•	•
9"									
Options	Threadless (N)	N							
	Male Threads (T)		T	T	T	T	T	T	T

CYLINDERS

BRASS

9/16" & 7/8" BORE CYLINDERS

BORE SIZE

9/16" (Continued from previous page)

Base Part No.		9SS-AR-	H9S-□S	H9S-□D	H9C-□S	H9C-□D	H9U-□S	H9U-□D	H9D-□D
Cylinder Type		Reverse-Acting	Single-Acting	Double-Acting	Single-Acting	Double-Acting	Single-Acting	Double-Acting	
Mounting Style		Stud			Clevis		Universal		Stud
Rod Type	Rotating	•	•	•	•	•	•	•	Double End
	Non-Rotating								
Available Stroke Lengths	3/4"								
	1"	•	•	•	•	•	•	•	•
	1-1/2"								
	2"		•	•	•	•	•	•	•
	3"		•	•	•	•	•	•	•
	4"			•		•		•	•
	5"			•		•		•	•
	6"			•		•		•	•
9"									
Options	Threadless (N)	N	N	N	N	N	N	N	N
	Male Threads (T)								

Part Numbering Schematic



Base Part No.

-



Stroke

-



Options

BORE SIZE

7/8"

Base Part No.		7SS-AR-	7SS-	7SD-	7S-	7D-	7DD-
Cylinder Type		Reverse-Acting	Single-Acting	Double-Acting	Single-Acting	Double-Acting	Double-Acting
Mounting Style		Stud			Universal		Stud
Rod Type	Rotating	•	•	•	•	•	Double End
	Non-Rotating						
Available Stroke Lengths	3/4"						
	1"	•	•	•	•	•	•
	1-1/2"						
	2"			•		•	•
	3"			•		•	•
	4"						
	5"			•		•	•
	6"						
7"			•		•	•	
9"			•		•	•	
Options	Threadless (N)	N	N	N	N	N	N

Air Volume Tanks



Air volume tanks are available in standard stainless steel, all stainless steel, or polypropylene. Each air volume tank includes a threaded port at both ends. See the charts below for tank volumes and ports.

Clippard stainless steel air volume tanks are manufactured using the same high quality, precision rolled construction as Clippard's superior stainless steel cylinders. For additional corrosion resistance, air volume tanks with acetal heads are also available.

- Volumes from 1 to 35 in.³
- 11 models
- Easy to connect, mount, and use in circuits



STAINLESS STEEL

Max. Pressure	250 psig
Material, Tubes	304 Stainless steel
Material, Heads	Aluminum
Options	Anodizing available

ALL STAINLESS STEEL

Max. Pressure	250 psig
Material, Tubes	304 Stainless steel
Material, Heads	304 Stainless steel

POLYPROPYLENE

Max. Pressure	125 psig
Material, Tubes	Polypropylene
Material, Heads	Polypropylene
Temp. Range	35 to 100°F
Mounting Clip	AVT-PP-CL

Part No.	Volume	Ports
AVT-12-1	1 in. ³	1/8-27
AVT-17-2	2 in. ³	1/8-27
AVT-17-3	3 in. ³	1/8-27
AVT-24-4	4 in. ³	1/8-27
AVT-24-6	6 in. ³	1/8-27
AVT-24-8	8 in. ³	1/8-27
AVT-24-10	10 in. ³	1/8-27
AVT-32-12	12 in. ³	1/4-18
AVT-32-14	14 in. ³	1/4-18
AVT-32-16	16 in. ³	1/4-18

Part No.	Volume	Ports
SS-AVT-12-1	1 in. ³	1/8-27
SS-AVT-17-2	2 in. ³	1/8-27
SS-AVT-17-3	3 in. ³	1/8-27
SS-AVT-24-4	4 in. ³	1/8-27
SS-AVT-24-6	6 in. ³	1/8-27
SS-AVT-24-8	8 in. ³	1/8-27
SS-AVT-24-10	10 in. ³	1/8-27
SS-AVT-32-12	12 in. ³	1/4-18
SS-AVT-32-14	14 in. ³	1/4-18
SS-AVT-32-16	16 in. ³	1/4-18

Part No.	Volume	Ports
AVT-PP-35	35 in. ³	1/4" PQ

PROUD SUPPORTER OF



Accessories

STAINLESS STEEL

BORE SIZE	Clevis Bracket Part No.	Foot Bracket Part No.	Rod End Part No.	Rod Clevis Part No.	Stud Nut Part No. (Thd.)	Rod Nut Part No. (Thd.)
5/16"	CB-0595	FB-0891 FB-0592	RE-0585	RC-0581	N04-28A (1/4-28) N04-28B (1/4-28) N06-24A (3/8-24) N06-24B (3/8-24)	N02-40 (5-40)
1/2"	CB-0895	FB-0891 FB-0892	RE-0885	RC-0881	N06-24A (3/8-24) N06-24B (3/8-24) N07-20 (7/16-20)	N03-32 (#10-32)
9/16"	CB-0895	FB-0892	RE-0885	RC-0881	N07-20 (7/16-20)	N03-32 (#10-32)
5/8"	CB-0895	FB-0891 FB-0892	RE-0885	RC-0881	N06-24A (3/8-24) N06-24B (3/8-24) N07-20 (7/16-20)	N03-32 (#10-32)
3/4"	CB-1795	FB-1291 FB-1791	RE-1285	RC-1281	N08-20 (1/2-20) N10-18 (5/8-18)	N04-28A (1/4-28) N04-28B (1/4-28)
7/8"	CB-1795	FB-1791	RE-1285	RC-1281	N10-18 (5/8-18)	N04-28A (1/4-28) N04-28B (1/4-28)
1-1/16"	CB-1795	FB-1791	RE-1785	RC-1781	N10-18 (5/8-18)	N05-24 (5/16-24)
1-1/4"	CB-2095	FB-2491	RE-2085	RC-2081	N12-16 (3/4-16)	N06-24A (3/8-24) N06-24B (3/8-24)
1-1/2"	CB-2495	FB-2491	RE-2485	RC-2481	N12-16 (3/4-16)	N07-20 (7/16-20)
1-3/4"	CB-2495	FB-2891	RE-3285	RC-3281	N16-14 (1-14)	N08-20 (1/2-20)
2"	CB-3295	FB-3291	RE-3285	RC-3281	N20-12 (1 1/4-12)	N08-20 (1/2-20)
2-1/2"	CB-3295	FB-4091	RE-3285	RC-3281	N22-12 (3/8-12)	N08-20 (1/2-20)
3"	CB-4895	FB-4891	RE-4885	RC-4881	N24-12 (1 1/2-12)	N10-18 (5/8-18)

ALL STAINLESS STEEL

BORE SIZE	Clevis Bracket Part No.	Foot Bracket Part No.	Rod End Part No.	Rod Clevis Part No.	Stud Nut Part No. (Thd.)	Rod Nut Part No. (Thd.)
3/4"	CB-1795-SS	FB-1791-SS	RE-1285	RC-1281-SS	N10-18-SS (5/8-18)	N04-28A-SS (1/4-28)
1-1/16"	CB-1795-SS	FB-1791-SS	RE-1785	RC-1781-SS	N10-18-SS (5/8-18)	N05-24-SS (5/16-24)
1-1/2"	CB-2495-SS	FB-2491-SS	RE-2485	RC-2481-SS	N12-16-SS (3/4-16)	N07-20-SS (7/16-20)
2"	CB-3295-SS	FB-3291-SS	RE-3285	RC-3281-SS	N20-12-SS (1 1/4-12)	N08-20-SS (1/2-20)

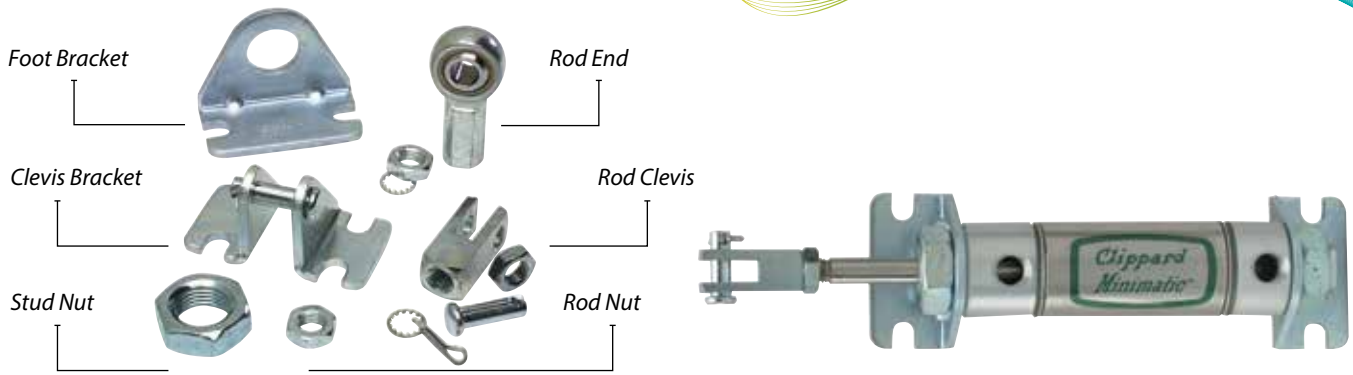

CORROSION-RESISTANT

BORE SIZE	Clevis Bracket Part No.	Foot Bracket Part No.	Rod Clevis Part No.	Stud Nut Part No. (Thd.)	Rod Nut Part No. (Thd.)
5/8"	—	FB-0892-SS	—	N07-20-SS (7/16-20)	—
3/4"	CB-1795-SS	FB-1791-SS	RC-1281-SS	N10-18-SS (5/8-18)	N04-28A-SS (1/4-28)
1-1/16"	CB-1795-SS	FB-1791-SS	RC-1781-SS	N10-18-SS (5/8-18)	N05-24-SS (5/16-24)
1-1/4"	—	FB-2491-SS	—	N16-14-SS (1-14)	—
1-1/2"	CB-2495-SS	FB-2891-SS	RC-2481-SS	N12-16-SS (3/4-16)	N07-20-SS (7/16-20)

BRASS

BORE SIZE	Clevis Bracket Part No.	Flat Bracket Part No.	Angled Bracket Part No.	Foot Bracket Part No.	Rod Clevis Part No.	Ceramic Insulator Part No.
3/8"	—	11917-2	11918-2	—	11996, Male 11997, Female	11767
9/16"	CB-1795	11917-1	11918-1	15018-2	15015 11996, Male 15009, Female	—
7/8"	—	—	—	15018-1	15015	—

COMPACT EXTRUDED

BORE SIZE	Foot Bracket Part No.	Auto Switch Model Foot Bracket Part No.	Rod Nut Part No. (Thd.)
12 mm	CQ2-1292	CQ2-1291	NM5-080 (M5x0.8)
16 mm	CQ2-1692	CQ2-1691	NM6-100 (M6x1.0)
20 mm	CQ2-2092	CQ2-2091	NM8-125 (M8x1.25)
25 mm	CQ2-2592	CQ2-2591	NM10-150 (M10x1.25)
32 mm	CQ2-3292	CQ2-3291	NM14-150 (M14x1.5)
40 mm	CQ2-4092	CQ2-4091	NM14-150 (M14x1.5)
50 mm	CQ2-5092	CQ2-5091	NM18-150 (M18x1.5)

Position Sensors

Clippard stainless steel cylinders that are equipped with a magnetic piston can be used with a **Reed Switch** or **GMR Sensor**. This is an excellent choice for position sensing in pneumatic system control—by accurately sensing the magnetic field of the piston when it passes beneath the sensor, the position of the rod piston is determined, and a feedback signal is created. Some of the benefits of Clippard’s position sensors include: small size, high durability, high sensitivity, high response time, low power consumption and low cost.

To determine which sensor is best suited for your application, refer to the selection chart on the next page.



REED SWITCH

Clippard’s **Reed Switch** is a Single Pole, Single Throw (SPST) Normally-Open electronic switch. When the cylinder’s magnet-equipped piston moves to a location where the magnet is positioned below the Reed Switch, the switch sends a feedback signal to indicate the location of the piston.

A 1/2” minimum stroke is required when multiple sensors are used.

Sourcing Switch with Wire Leads	RPS-P3
Sourcing Switch with Quick-Connect	RPS-P8Q
Sinking Switch with Wire Leads	RPS-N3
Sinking Switch with Quick-Connect	RPS-N8Q
Simple Switch with Wire Leads	RPS-S3
Simple Switch with Quick-Connect	RPS-S8Q

ACCESSORIES

Clippard’s **Universal Mounting Bracket** is designed for use with a Reed Switch or GMR Sensor, on any Clippard Stainless Steel cylinder equipped with a magnetic piston. Hex wrench included.

Universal Mounting Bracket	UC-0848
Mating Cable	CPS-C8Q5

GMR SENSOR

Clippard’s **GMR Sensor** is a solid-state device made up of alternating layers of conductive magnetic and non-magnetic materials. When a magnetic field is applied, there is a large drop in resistance. This decrease produces a signal that can be used to determine the location of the piston.

Sourcing Switch with Wire Leads	GPS-P3
Sourcing Switch with Quick-Connect	GPS-P8Q
Sinking Switch with Wire Leads	GPS-N3
Sinking Switch with Quick-Connect	GPS-N8Q

DIMENSIONS

All RPS- and GPS- Position Sensors

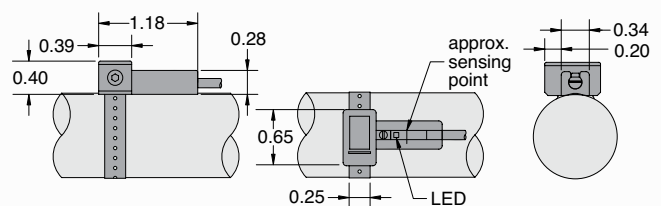

ACCESSORIES

POSITION SENSORS

Part No.	RPS-S3	RPS-S8Q	RPS-N3	RPS-N8Q	RPS-P3	RPS-P8Q	GPS-N3	GPS-N38Q	GPS-P3	GPS-P8Q
Temp. Range	14 to 158°F									
Vibration	9 G									
Enclosure Class.	IP 67 (NEMA 6)									
Connection	3 mm wire leads	8 mm male QC*, 6" pigtail	3 mm wire leads	8 mm male QC*, 6" pigtail	3 mm wire leads	8 mm male QC*, 6" pigtail	3 mm wire leads	8 mm male QC*, 6" pigtail	3 mm wire leads	8 mm male QC*, 6" pigtail
Sensor	Simple switch (2-wire)		NPN current, sinking		PNP current, sourcing		NPN current, sinking		PNP current, sourcing	
Indicator	Red LED		Red LED		Green LED		Red LED		Green LED	
Circuit Diagram										
Oil-Resistant PVC Cable	2.8 S, 2C		2.8 S, 3C		2.8 S, 3C		2.8 S, 3C		2.8 S, 3C	
Max. Switching Freq.	200 Hz		1,000 Hz		1,000 Hz		5,000 Hz		5,000 Hz	
Operating Voltage	5 to 120 VAC	5 to 60 VAC/VDC	5 to 30 VDC		5 to 30 VDC		5 to 28 VDC		5 to 28 VDC	
Max. Current	100 mA		250 mA		250 mA		200 mA		200 mA	
Current Consumption	—		10 mA max. @ 24 V (switch active)		10 mA max. @ 24 V (switch active)		7.5 mA max. @ 24 V (switch active)		7.5 mA max. @ 24 V (switch active)	
Max. Voltage Drop	2.5 V @ 40 mA DC		0.5 V @ 550 mA (resistive load)		0.5 V @ 550 mA (resistive load)		0.5 V @ 200 mA (resistive load)		0.5 V @ 200 mA (resistive load)	
Logic	Single Pole, Single Throw, Normally-Open						Solid-State, Normally-Open			
Type	Reed Switch						GMR Sensor			
Max. Rating	10 W						6 W			
Sensitivity	60 G						40 ~ 750 G			
Max. Leakage Current	—						0.01 mA			
Shock	30 G						50 G			
Protection Circuit	—						Power source reverse polarity; surge suppression			
More Info	clippard.com/link/reed-switch					clippard.com/link/gmr-sensor				

QUICK-CONNECT WIRING DIAGRAMS

Part No.	2-Wire Quick-Connect	3-Wire Quick-Connect
Wire Diagram	<p>RPS-S8Q</p>	<p>RPS-N8Q, RPS-P8Q, GPS-N8Q, GPS-P8Q</p>

Air Preparation Equipment



FRLS

- Improve system efficiency
- Side-by-side and stacking units available
- Modular design for easy connection and maintenance
- Variety of port sizes from #10-30 to 1" NPT

pp. 170-174



FILTERS

- Capture solid particulates and remove water by "spinning" the air centrifugally
- Smaller particles are captured as the air flows through the filter element
- Variety of port sizes from #10-32 to 1" NPT
- Manual, automatic, and semi-automatic drain types
- Polycarbonate or metal bowls
- 25 micron filtration standard, 5 micron also available

p. 175



REGULATORS

- Adjustable from 7 to 125 psig
- 7 to 30 or 7 to 60 psig models with spring also available
- Variety of port sizes from #10-32 to 1" NPT

p. 176



LUBRICATORS

- *Pneumatic actuators and valves perform better and last longer when properly lubricated*
- *Bowl serves as a reservoir*
- *Amount of oil dispersed is controlled by an adjustable needle valve*
- *Variety of port sizes from #10-32 to 1" NPT*
- *Polycarbonate or metal bowls*

p. 176

ACCESSORIES

- *Relieving shut-off/lock-out valves*
- *Drain and bowl options*
- *Replacement bowls*
- *Muffler and nipple*
- *Brackets, spacers, and other mounting hardware*

pp. 177-179

MAXIMATIC® SERIES FRLS

FILTERS, REGULATORS & LUBRICATORS

Maximatic FRLs condition and prepare compressed air for use in fluid power systems. Pneumatic applications with properly conditioned air will operate longer, cost less and improve system efficiency. Clippard offers many different sizes from #10-32 to 1" NPT of filters, regulators, lubricators, and combination units. Their modular design and interconnecting brackets provide flexibility and facilitate simple field installation and/or modification.



Body Material	Die cast aluminum
Max. Operating Pressure	150 psig
Regulating Range	125 psig standard; 30 psig and 60 psig optional
Regulator Type	Relieving
Filter Drain	Semi-automatic differential; automatic available <i>When the air supply is below 7 psig, the semi-automatic drain will open</i>
Bowl Material	Polycarbonate, metal, and cast aluminum
Bowl Guard	Steel (on models indicated)
Filtration	25 micron sintered brass filter standard; 5 micron available

FILTERS

Filters capture solid particulate and remove water by spinning the air centrifugally. Water and larger particles are thrown against the side of the bowl where they condense and/or fall to the lower part of the bowl. Smaller particles are captured as the air flows through the filter element.

REGULATORS

Controlling pressure is an important requirement in all systems. Maximatic regulators are adjustable from 7 to 125 psig. For applications requiring better resolution, 7 to 30 or 7 to 60 psig models with spring are available. The #10-32 size is a piston-style due to its small size, while the 1/8" to 1" feature a diaphragm design.

LUBRICATORS

Pneumatic actuators and valves perform better and last longer when properly lubricated. The bowl serves as a reservoir and supplies oil through the pick-up tube when pressurized. The amount of oil dispersed is controlled by an adjustable needle valve.

ORDERING INFORMATION

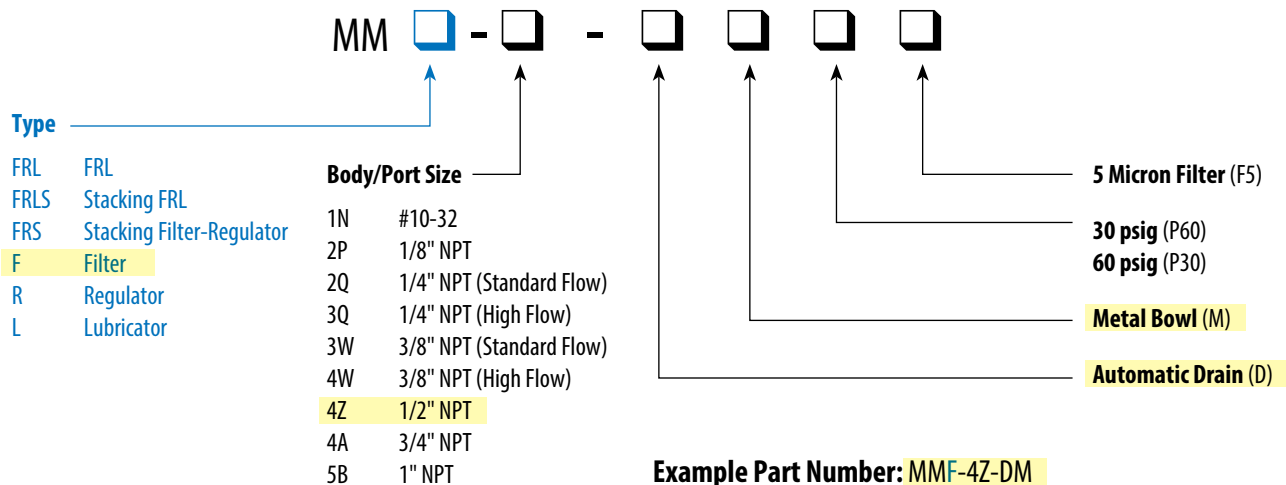

Maximatic® Series FRLs

All FRL components are a modular design which allow easy connection and disconnection of the components for simple installation and maintenance.

Die cast aluminum body

Lubricators increase component life by dispensing oil into the airline supply

25 micron filters standard, 5 micron optional

Filters prevent moisture and solid particulates from getting into compressed air lines

Manual, semi-automatic, or automatic drain

Regulator ensures a constant downstream air line pressure

Many Models In Stock & Available for Same-Day Shipping

For more information, visit clippard.com/link/frl



Bowl shield



Metal bowl with sight glass

- Large selection of convenient mounting hardware
- #10-32 through 1" NPT ports available
- Easy-to-view sight glass standard on all metal bowls
- Flow rates from 85 to 7,900 l/min
- Pressure gauge included

Polycarbonate bowls are standard on all filters and lubricators. Bowl shields are standard on MMF/MML 4A and 5B. Optional metal bowl available for filters and lubricators.

MAXIMATIC® SERIES FRLS

FILTER-REGULATOR-LUBRICATOR COMBINATION UNITS



Combination FRLs provide air filtration, regulation and lubrication in one unit for easy mounting and installation. Includes L brackets and gauge.

Bowl: Polycarbonate standard. Steel bowl shields provided on models indicated. Metal bowls with sight glasses also available, add -M suffix to part number.

Regulating Range: 7 to 100 psig on MMFRL-1N, 7 to 125 psig on all others. 30 and 60 psig ranges also available (add -P30 or -P60 suffix to part number).

Drain: Semi-automatic standard on MMFRLS-3 series; manual standard on all others. Automatic drain available—add -D suffix to part number.

Note: Drains not available on lubricators.

Filtration: 25 micron filter standard. 5 micron filter available (add -F5 suffix to part number).

Port	Gauge Port	Flow Rate	Manual Drain	Semi-Auto Drain	Automatic Drain	Standard Bowl*	Gauge
#10-32	1/16" NPT	85 l/min	MMFRL-1N	-	MMFRL-1N-D*	Polycarbonate	PG-10-160J
1/8" NPT	1/8" NPT	510 l/min	MMFRL-2P	-	MMFRL-2P-D*	Polycarbonate	PG-15-160P
1/4" NPT	1/8" NPT	510 l/min	MMFRL-2Q	-	MMFRL-2Q-D*	Polycarbonate	PG-15-160P
1/4" NPT	1/8" NPT	2,000 l/min	-	MMFRL-3Q*	MMFRL-3Q-D*	Poly with Shield	PG-15-160P
3/8" NPT	1/8" NPT	2,000 l/min	-	MMFRL-3W*	MMFRL-3W-D*	Poly with Shield	PG-15-160P
3/8" NPT	1/4" NPT	4,000 l/min	MMFRL-4W	-	MMFRL-4W-D*	Poly with Shield	PG-20-160Q
1/2" NPT	1/4" NPT	4,000 l/min	MMFRL-4Z	-	MMFRL-4Z-D*	Poly with Shield	PG-20-160Q
3/4" NPT	1/4" NPT	4,500 l/min	MMFRL-4A-M	-	MMFRL-4A-M-D*	Poly with Shield	PG-20-160Q
1" NPT	1/4" NPT	5,100 l/min	MMFRL-5B-M	-	MMFRL-5B-M-D*	Poly with Shield	PG-20-160Q

*Add -M suffix to part number for metal bowl with sight glass

MAXIMATIC® SERIES FRLS

STACKING FILTER-REGULATOR-LUBRICATORS

AIR PREPARATION EQUIPMENT



MMFRLS-2Q-D
Stacking FRL with polycarbonate bowls & automatic drain



MMFRLS-3Q-D
Stacking FRL with bowl shields & automatic drain

Stacking FRLs provide air filtration, regulation and lubrication in one unit for easy mounting and installation. Includes L bracket and gauge

Bowl: Polycarbonate standard. Steel shield provided on models indicated. Metal bowl with sight glass also available, add -M suffix to part number.

Regulating Range: 7 to 100 psig on MMFRLS-1N, 7 to 125 psig on all others. 30 and 60 psig ranges also available (add -P30 or -P60 suffix to the part number).

Drain: Semi-automatic standard on MMFRLS-3/4/5 series; manual standard on all others. Automatic drain available—add -D suffix to part number.

Filtration: 25 micron filter standard. 5 micron filter available (add -F5 suffix to part number).



Port	Gauge Port	Flow Rate	Manual Drain	Semi-Auto Drain	Automatic Drain	Standard Bowl*	Gauge
#10-32	1/16" NPT	85 l/min	MMFRLS-1N	-	-	Polycarbonate	PG-10-160J
1/8" NPT	1/8" NPT	510 l/min	MMFRLS-2P	-	-	Polycarbonate	PG-15-160P
1/4" NPT	1/8" NPT	510 l/min	MMFRLS-2Q	-	-	Polycarbonate	PG-15-160P
1/4" NPT	1/8" NPT	1,700 l/min	-	MMFRLS-3Q*	MMFRLS-3Q-D*	Poly with Shield	PG-15-160P
3/8" NPT	1/8" NPT	1,700 l/min	-	MMFRLS-3W*	MMFRLS-3W-D*	Poly with Shield	PG-15-160P
3/8" NPT	1/4" NPT	3,000 l/min	-	MMFRLS-4W*	MMFRLS-4W-D*	Poly with Shield	PG-20-160Q
1/2" NPT	1/4" NPT	3,000 l/min	-	MMFRLS-4Z*	MMFRLS-4Z-D*	Poly with Shield	PG-20-160Q
3/4" NPT	1/4" NPT	4,000 l/min	-	MMFRLS-4A-M	MMFRLS-4A-DM	Poly with Shield	PG-20-160Q
1" NPT	1/4" NPT	4,000 l/min	-	MMFRLS-5B-M	MMFRLS-5B-DM	Poly with Shield	PG-20-160Q

*Add -M suffix to part number for metal bowl with sight glass

MAXIMATIC® SERIES FRLS

STACKING FILTER-REGULATOR-LUBRICATORS



MMFRS-3Q
Stacking filter-regulator
with bowl shield &
semi-automatic drain



MMFRS-2P
Stacking filter-regulator
with polycarbonate bowl
& manual drain

Stacking filter-regulator combinations provide air filtration and precise regulation in a single unit for easy mounting and installation where space is limited. Includes bracket and gauge.

Regulating Range

7 to 100 psig on MMFRS-1N, 7 to 125 psig on all others. 30 and 60 psig ranges also available (add -P30 or -P60 suffix to part number).

Bowl

Polycarbonate standard. Steel bowl shields provided on models indicated. Metal bowls with sight glasses also available, add -M suffix to part number.

Differential Drain

Semi-automatic standard on MMFRS-3/4/5 series; manual standard on all other models. When supply pressure is below 7 psig on all MMFRS-3 and MMFRS-4 models without metal bowls, the standard drain will open. An optional automatic drain is also available—add -D suffix to part number (not available with MMFRS-4A-M).

Filtration

25 micron filter standard. 5 micron filter available (add -F5 suffix to part number). Replacement filters with baffles are also available (p. 177).

Port	Gauge Port	Manual Flow Rate	Semi-Auto Drain	Automatic Drain	Standard Drain	Bowl*	Gauge
#10-32	1/16" NPT	85 l/min	MMFRS-1N	-	-	Polycarbonate	PG-10-160J
1/8" NPT	1/8" NPT	540 l/min	MMFRS-2P	-	MMFRS-2P-D*	Polycarbonate	PG-15-160P
1/4" NPT	1/8" NPT	540 l/min	MMFRS-2Q	-	MMFRS-2Q-D*	Polycarbonate	PG-15-160P
1/4" NPT	1/8" NPT	2,000 l/min	-	MMFRS-3Q*	MMFRS-3Q-D*	Poly with Shield	PG-15-160P
3/8" NPT	1/8" NPT	2,000 l/min	-	MMFRS-3W*	MMFRS-3W-D*	Poly with Shield	PG-15-160P
3/8" NPT	1/4" NPT	4,000 l/min	-	MMFRS-4W*	MMFRS-4W-D*	Poly with Shield	PG-20-160Q
1/2" NPT	1/4" NPT	4,000 l/min	-	MMFRS-4Z*	MMFRS-4Z-D*	Poly with Shield	PG-20-160Q
3/4" NPT	1/4" NPT	4,500 l/min	-	MMFRS-4A-M	-	Metal with Site Glass	PG-20-160Q
1" NPT	1/4" NPT	5,500 l/min	-	MMFRS-5B-M	MMFRS-5B-D*	Metal with Site Glass	PG-20-160Q

*Add -M suffix to part number for metal bowl with sight glass

MAXIMATIC® SERIES FRLS

FILTERS



MMF-3Q-D
Filter with bowl shield
& automatic drain



MMF-2Q
Filter with polycarbonate
bowl & manual drain



MMF-2Q-D
Filter with polycarbonate
bowl & automatic drain



MMF-2Q-MD
Filter with metal bowl
& automatic drain

Maximatic filters remove moisture and contaminants, and provide air filtration through a 25 micron filter. Replacement 25 micron and 5 micron filters are available.

Bowl: Polycarbonate standard. Cast steel bowl shield provided on models indicated. Metal bowl with sight glass also available, add -M suffix to part number.

Drain: Semi-automatic standard on MMFRLS-3/4/5 series; manual standard on all others. Automatic drain available—add -D suffix to part number.

Filtration: 25 micron filter standard. 5 micron filter available (add -F5 suffix to part number). Replacement filters with baffles are also available (p. 177).

Port	Flow Rate	Manual Drain	Semi-Automatic Drain	Automatic Drain	Standard Bowl*
#10-32	113 l/min	MMF-1N	-	-	Polycarbonate
1/8" NPT	740 l/min	MMF-2P	-	MMF-2P-D*	Polycarbonate
1/4" NPT	740 l/min	MMF-2Q	-	MMF-2Q-D*	Polycarbonate
1/4" NPT	2,000 l/min	-	MMF-3Q*	MMF-3Q-D*	Poly with Steel Shield
3/8" NPT	2,000 l/min	-	MMF-3W*	MMF-3W-D*	Poly with Steel Shield
3/8" NPT	4,000 l/min	-	MMF-4W*	MMF-4W-D*	Poly with Steel Shield
1/2" NPT	4,000 l/min	-	MMF-4Z*	MMF-4Z-D*	Poly with Steel Shield
3/4" NPT	5,900 l/min	-	MMF-4A-M	MMF-4A-DM	Metal with Site Glass
1" NPT	6,900 l/min	-	MMF-5B-M	MMF-5B-DM	Metal with Site Glass

*Add -M suffix to part number for metal bowl with sight glass

MAXIMATIC® SERIES FRLS

REGULATORS & LUBRICATORS

Maximatic regulators provide precise air regulation from 7 to 125 psig. The adjustment knob must be pulled out to adjust the pressure, preventing accidental adjustment. Maximum inlet pressure is 150 psig. Includes bracket and gauge.

Regulating Range: 7 to 100 psig on MMR-1N, 7 to 125 psig on all others. 30 and 60 psig ranges also available (add -P30 or -P60 suffix to part number).



MMR-3Q

Part No.	Port	Gauge Port	Flow Rate	Gauge
MMR-1N	#10-32	1/16" NPT	113 l/min	PG-10-160J
MMR-2P	1/8" NPT	1/8" NPT	540 l/min	PG-15-160P
MMR-2Q	1/4" NPT	1/8" NPT	540 l/min	PG-15-160P
MMR-3Q	1/4" NPT	1/8" NPT	2,500 l/min	PG-15-160P
MMR-3W	3/8" NPT	1/8" NPT	2,500 l/min	PG-15-160P
MMR-4W	3/8" NPT	1/4" NPT	4,000 l/min	PG-20-160Q
MMR-4Z	1/2" NPT	1/4" NPT	4,000 l/min	PG-20-160Q
MMR-4A	3/4" NPT	1/4" NPT	5,900 l/min	PG-20-160Q
MMR-5B	1" NPT	1/4" NPT	7,900 l/min	PG-20-160Q



MML-3W
Lubricator
with bowl
shield



MML-2P
Lubricator
with
polycarb.
bowl



MML-2Q-M
Lubricator
with metal
bowl

These inexpensive direct-flow lubricators provide lubrication to downstream valves and actuators

Bowl: Polycarbonate standard. Steel bowl shields provided on models indicated. Metal bowls with sight glasses also available, add -M suffix to part number.

LUBRICATOR BOWL FLUID CAPACITY

Model	Bowl #	Capacity
MML-2	27057-2	0.8 oz./24 ml (cc)
MML-3	27057-3	2.3 oz./68 ml (cc)
MML-4	27057-4	6.2 oz./183 ml (cc)

Port	Flow Rate	Polycarbonate Bowl	Poly Bowl with Shield	Metal Bowl
#10-32	85 l/min	MML-1N	-	-
1/8" NPT	790 l/min	MML-2P	-	MML-2P-M
1/4" NPT	790 l/min	MML-2Q	-	MML-2Q-M
1/4" NPT	1,700 l/min	-	MML-3Q	MML-3Q-M
3/8" NPT	1,700 l/min	-	MML-3W	MML-3W-M
3/8" NPT	5,100 l/min	-	MML-4W	MML-4W-M
1/2" NPT	5,100 l/min	-	MML-4Z	MML-4Z-M
3/4" NPT	6,200 l/min	-	MML-4A	MML-4A-M
1" NPT	6,900 l/min	-	MML-5B	MML-5B-M

LUBRICATOR OIL DRIP DOME KITS

Includes glass dome, drip tube, and o-ring

Model	Bowl #
MML-2	27057-2
MML-3	27057-3
MML-4	27057-4

MAXIMATIC® SERIES

VALVES, ACCESSORIES & OPTIONS

RELIEVING SHUT-OFF/LOCK-OUT VALVES

May be used in conjunction with Maximatic® FRLs to provide a method of turning off the air supply. Enables filters to be cleaned or replaced, oil to be added to the lubricator, or other maintenance steps to be performed without the air supply.

Valve can also be locked in the "off" position to prevent accidental pressurizing (lock not included).

Part No.	Port	Vent Port	Flow Rate @ 100 psig	Compatible Series (FRL, FRLS, FR, FRS, F, R)
MMSV-3PP	1/8" NPT	1/8" NPT	510 l/min	-2 Series
MMSV-3QP	1/4" NPT	1/8" NPT	710 l/min	-2 Series
MMSV-3QQ	1/4" NPT	1/4" NPT	1,700 l/min	-3 Series
MMSV-3WQ	3/8" NPT	1/4" NPT	2,600 l/min	-3 Series
MMSV-3WW	3/8" NPT	3/8" NPT	3,400 l/min	-4W & -4Z Series
MMSV-3ZW	1/2" NPT	3/8" NPT	5,100 l/min	-4W & -4Z Series

Medium	Air
Air Flow	See table below
Material	Die Cast Aluminum
Input Pressure	150 psig
Mounting	In-line



AIR PREPARATION EQUIPMENT

FILTER DRAIN OPTIONS



REPLACEMENT FILTERS

Filter Series	5 micron	25 micron
MMF-1	27021	27050
MMF-2	27022	27051
MMF-3	27023	27052
MMF-4	27024	27053
MMF-5	27025	27054

Filter Replacement Bowls

Polycarbonate Bowl	Manual Drain	Semi-Auto Drain	Automatic Drain
MMF-1 Series	27055-1	-	-
MMF-2 Series	27055-2	-	27055-2-A
MMF-3 Series	-	27055-3	-
MMF-4/5 Series	-	27055-4	-
Metal Bowl Shield			
MMF-3 Series	-	27070-3	27070-3-A
MMF-4/5 Series	-	27070-4	-
Metal Bowl with Site Glass			
MMF-2 Series	27059-2	-	27059-2-A
MMF-3 Series	-	27059-3	27059-3-A
MMF-4/5 Series	-	27059-4	27059-4-A

BOWL OPTIONS



Lubricator Replacement Bowls

	Polycarbonate	Bowl Shield	Metal Bowl*
MML-1 Series	27057-1	-	-
MML-2 Series	27057-2	-	27060-2
MML-3 Series	27057-3	27070-3	27060-3
MML-4/5 Series	27057-4	27070-4	27060-4

*All metal bowls come complete with a sight glass

MUFFLER & NIPPLE



Part No.	Description
3849-1	1/8" NPT Polyethylene Muffler
9002-01	1/8" NPT Hex Nipple with Micron Filter

MAXIMATIC® SERIES

ACCESSORIES

Mounting Hardware for Lubricators & Filters

No brackets are furnished with lubricators or filters. Comes with two screws to mount bracket to MMF/MML.



Replacement Mounting Hardware for Regulators & Stacked Filter-Regulators

Brackets are included with the purchase of these components. Mounting screws not provided.



Filter/Lubricator	Bracket Mounting Thread	Bracket Part No.
MMF-2P	M4	MMH-B240
MML-2P	M4	MMH-B240
MMF-3	M4	MMH-B340
MML-3	M4	MMH-B340
MMF-4Z/4W	M5	MMH-B440
MML-4Z/4W	M5	MMH-B440
MMF-4A	M5	MMH-B540
MML-4A	M5	MMH-B540
MMF-5	M6	MMH-B640
MML-5	M6	MMH-B640

Regulator	Bracket Part No.
MMR-1N/MMFRS-1N	MMH-B120
MMR-2P/2Q	MMH-B220
MMFRS-2P/2Q	MMH-B220
MMR-3Q/3W	MMH-B320
MMFRS-3Q/3W	MMH-B320
MMR-4W/4Z/4A	MMH-B420
MMFRS-4W/4Z/4A	MMH-B420
MMR-5B	MMH-B420
MMFRS-5B	MMH-B420

Spacers

To convert individual filter, regulator and lubricators into combination units without mounting brackets. Seals included.



Spacers with Quick Exhaust

Threaded pipe adapters allow for a component to be quickly and easily removed from the airline for replacement or service. Adapters can be used to allow for different pipe diameters in the configuration.



Series	Part No.
FRL-1	MMH-Y10
FRL-2	MMH-Y20
FRL-3	MMH-Y30
FRL-4W/4Z	MMH-Y40
FRL-4A	MMH-Y50
FRL-5	MMH-Y60

FRL Series	Part No.	Port Size
FRL-2	MMH-PA-2P	1/8" NPT
FRL-2	MMH-PA-2Q	1/4" NPT
FRL-2	MMH-PA-2W	3/8" NPT
FRL-3	MMH-PA-3Q	1/4" NPT
FRL-3	MMH-PA-3W	3/8" NPT
FRL-3	MMH-PA-3Z	1/2" NPT
FRL-4W/4Z	MMH-PA-4W	3/8" NPT
FRL-4W/4Z	MMH-PA-4Z	1/2" NPT
FRL-5	MMH-PA-5A	3/4" NPT
FRL-5	MMH-PA-5B	1" NPT

MAXIMATIC® SERIES

ACCESSORIES

T & L Brackets

L brackets are included with the purchase of combination FRLs, to convert to T, use T bracket only. If no bracket is furnished, use T or L bracket with MMH-YXX spacer (ordered separately).

FRL Series	L Bracket Part No.
FRL-1	MMH-B110L
FRL-2	MMH-B210L
FRL-3	MMH-B310L
FRL-4W/4Z	MMH-B410L
FRL-4A	MMH-B510L
FRL-5	MMH-B610L



FRL Series	T Bracket Part No.
FRL-1	MMH-B110T
FRL-2	MMH-B210T
FRL-3	MMH-B310T
FRL-4W/4Z	MMH-B410T
FRL-4A	MMH-B510T
FRL-5	MMH-B610T



Mounting Hardware for Combination Units

To convert individual filter, regulator and lubricators into combination units. Seals included.

FRL Series	Spacer with L Bracket
FRL-1	MMH-Y10L
FRL-2	MMH-Y20L
FRL-3	MMH-Y30L
FRL-4W/4Z	MMH-Y40L
FRL-4A	MMH-Y50L
FRL-5	MMH-Y60L



FRL Series	Spacer with T Bracket
FRL-1	MMH-Y10T
FRL-2	MMH-Y20T
FRL-3	MMH-Y30T
FRL-4W/4Z	MMH-Y40T
FRL-4A	MMH-Y50T
FRL-5	MMH-Y60T



Spacers with Auxiliary Port

Provides parallel port between components.



MMH-Y21-N01

FRL Series	Spacer with Port	Spacer with L Bracket & Port	Spacer with T Bracket & Port
FRL-2	MMH-Y21-N01 (1/8")	MMH-Y21L-N01 (1/8")	MMH-Y21T-N01 (1/8")
	MMH-Y21-N02 (1/4")	MMH-Y21L-N02 (1/4")	MMH-Y21T-N02 (1/4")
FRL-3	MMH-Y31-N01 (1/8")	MMH-Y31L-N01 (1/8")	MMH-Y31T-N01 (1/8")
	MMH-Y31-N02 (1/4")	MMH-Y31L-N02 (1/4")	MMH-Y31T-N02 (1/4")
FRL-4W/4Z	MMH-Y41-N02 (1/4")	MMH-Y41L-N02 (1/4")	MMH-Y41T-N02 (1/4")
	MMH-Y41-N03 (3/8")	MMH-Y41L-N03 (3/8")	MMH-Y41T-N03 (3/8")
FRL-5	MMH-Y61-N03 (3/8")	MMH-Y61L-N03 (3/8")	MMH-Y61T-N03 (3/8")
	MMH-Y61-N04 (1/2")	MMH-Y61L-N04 (1/2")	MMH-Y61T-N04 (1/2")

Fittings & Tubing



MINIMATIC® FITTINGS

- *Barb Connectors*..... p. 182
- *Elbow Barb Fittings*..... p. 183
- *#10-32 Branch Tees*..... p. 183
- *Cross Fittings*..... p. 184
- *Nipples and Couplings*..... p. 184
- *L, T, X Fittings*..... p. 184
- *#10-32 Run Tee*..... p. 183
- *NPT to Barb Connectors*..... p. 184
- *Pipe Reducers*..... p. 187
- *Screw Plugs*..... p. 184
- *Bulkhead Fittings*..... p. 184
- *Compression Fittings*..... p. 187

STAINLESS STEEL PUSH-QUICK FITTINGS

- *High corrosion and chemical resistance*
 - *Ideal for high temperature applications*
 - *Tubing sizes 5/32" to 3/8"*
 - *Large variety of thread sizes*
- p. 185

PLASTIC RESIN PUSH-QUICK FITTINGS

- *Provide higher flow capability*
 - *For use with flexible hose and stiff tubing*
 - *9 tubing and 10 thread sizes*
 - *Choose from over 25 unique styles*
- p. 186



QUICK-CONNECT ASSEMBLIES

- *Easy connection in tight spaces without disconnecting tubing*
- *Includes check valve to close when disconnected*

p. 187

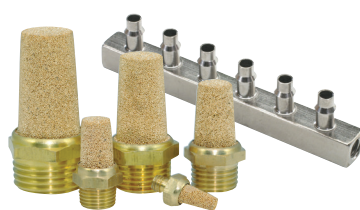

ACCESSORIES

- *Terminal Blocks*
- *Manifolds*
- *Mufflers*
- *Hose Clamps*
- *Fittings Kits*

p. 187



HOSE & TUBING

- *Vinyl, polyurethane, and silicone*
- *Single, dual, and ribbon styles*
- *Choose from a large variety of sizes and colors*

p. 188

MINIMATIC® FITTINGS

BARB CONNECTORS

	Part No.	Barb (I.D.)	Material	
	#3-56 Male to 1/16" Barb 1/8" Hex	11750-2	1/16"	Brass
	#10-32 Male to Single Barb, 1/4" Hex	11752-5 11752-8 11752-4 CT2 CT3 CT4	1/16" 3/32" 1/8" 1/16" 3/32" 1/8"	Brass Brass Brass ENP Brass ENP Brass ENP Brass
	#10-32 Male to Multi-Barb, 1/4" Hex	11752-2 11752-3 11752-1	1/16" 1/8" 1/8"	Brass Brass Brass
	#10-32 Male to Barb, 1/4" Hex (Capt. O-Rings)	11792-5 11792-8 11792-4	1/16" 3/32" 1/8"	Brass Brass Brass
	#10-32 Male to Barb, 5/16" Hex (Capt. O-Rings)	11782-5-ENP 11782-4-ENP	1/16" 1/8"	ENP Brass ENP Brass
	#10-32 Male Flush to Barb	12841 12843 12842	1/16" 3/32" 1/8"	Brass Brass Brass
	#10-32 Male to Barb	15045*	1/8"	Brass

*Not to be used as a constant rotation junction

Minimatic barb fittings provide a flexible, easy alternative to ferrule and push-to-connect design fittings. Electroless nickel plating provides corrosion resistance in applications involving high moisture. Nitrile gasket included with #10-32 threads except when ordered in bulk.

- In stock and ready to ship
- Low cost
- Miniature size provides low profile
- Holds to the burst pressure of polyurethane hose
- Low leak potential

	Part No.	Barb (I.D.)	Material	
	#10-32 Female to Barb	CF2 CF3 CF4	1/16" 3/32" 1/8"	ENP Brass ENP Brass ENP Brass
	Barb-to-Barb	C22 C32 C42 C33 C43 C44	1/16-1/16" 1-16-3/32" 1/16-1/8" 3/32-3/32" 3/32-1/8" 1/8-1/8"	ENP Brass ENP Brass ENP Brass ENP Brass ENP Brass ENP Brass
	1/8" NPT Male Swivel	15055*	1/8"	Brass
	Male NPT Flush Fitting	12844 12845	1/4" (1/8 NPT) 1/4" (1/4 NPT)	Brass Brass

Requires thread sealant.

All barbs are noted in I.D.



GASKETS

Designed for use with #10-32 threads

	Material	Part No.	O.D.	I.D.
	Nitrile	11761-2	0.240	0.150
	FKM	11761-8	0.240	0.150
	Nylon	11761-4	0.307	0.192
	EPDM	11761-7	0.240	0.150

MINIMATIC® FITTINGS

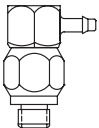
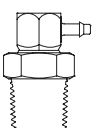

ELBOW BARB FITTINGS

	Part No.	Barb (I.D.)	Material
	#10-32 Male to Barb	CTO-2 1/16"	ENP Brass
		CTO-3 3/32"	ENP Brass
		CTO-4 1/8"	ENP Brass
	#10-32 Male to Barb Universal	UTO-2 1/16"	ENP Brass
		UTO-3 3/32"	ENP Brass
		UTO-4 1/8"	ENP Brass
	Universal #10-32	UTO-F	ENP Brass
	#10-32 Male to Barb Swivel	STO-2 1/16"	ENP Brass
		STO-3 3/32"	ENP Brass
		STO-4 1/8"	ENP Brass
	1/8" NPT Male to Barb Swivel	SPO-2 1/16"	ENP Brass
		SPO-3 3/32"	ENP Brass
		SPO-4 1/8"	ENP Brass

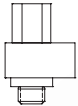
#10-32 RUN TEE

Part No.	Material
 UTF-F	ENP Brass

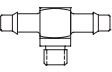
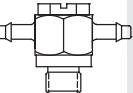
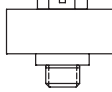
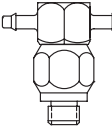
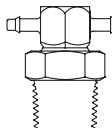
#10-32 BRANCH TEES

	Part No.	Barb (I.D.)	Material
	#10-32 Male to Barb	TT0-202 1/16"	ENP Brass
		TT0-303 3/32"	ENP Brass
		TT0-402 1/8"-1/16"	ENP Brass
		TT0-404 1/8"	ENP Brass
	#10-32 Male Universal	UTO-2002 1/16"	ENP Brass
		UTO-3002 1/16-3/32"	ENP Brass
		UTO-3003 3/32"	ENP Brass
		UTO-4002 1/8-1/16"	ENP Brass
	#10-32 Male Universal	UTO-4003 1/8-3/32"	ENP Brass
		UTO-4004 1/8"	ENP Brass
		UTO-F0F -	ENP Brass
	#10-32 Male Swivel	STO-2002 1/16"	ENP Brass
		STO-3003 3/32"	ENP Brass
		STO-4004 1/8"	ENP Brass
	1/8" NPT Male Swivel	SPO-2002 1/6"	ENP Brass
		SPO-3003 3/32"	ENP Brass
		SPO-4004 1/8"	ENP Brass
	Barb-to-Barb	T22-2 1/16"	ENP Brass
		T22-3 1/16 - 3/32 - 1/16"	ENP Brass
		T22-4 1/16 - 1/8 - 1/16"	ENP Brass
		T33-2 3/32 - 1/16 - 3/32"	ENP Brass
		T33-3 3/32"	ENP Brass
		T33-4 3/32 - 1/8 - 3/32"	ENP Brass
		T44-2 1/8 - 1/16 - 1/8"	ENP Brass
		T44-3 1/8 - 3/32 - 1/8"	ENP Brass
	T44-4 1/8"	ENP Brass	

All barbs are noted in I.D.

Hose/Tubing Size. The use of different sizes of hose or tubing in your circuits deserves some care and consideration. In general, follow the manufacturer's guide for the size of hose/tubing you use. For air logic circuits, we recommend 1/16" ID for pilots and 1/8" ID for supplies and outputs.

Tightening #10-32 Fittings. TIGHTEN WITH CARE. Often a "finger tight" connection between Clippard fittings with anaerobic sealant is all that is required. When using a gasket, most Clippard #10-32 threaded fittings require no more than 9 inch-pounds of torque to seal. We recommend that this force not be exceeded. Use wrench #11770 with a 1/4" and 5/16" open-end.

Swivel Fittings. Minimatic swivel connector fittings are very efficient in applications where joints need to be disconnected and reconnected frequently. Made with a threaded connection on one end and a swivel connection on the other, these fittings provide a true cost savings on pneumatic circuit designs. They are valuable also where short lengths of hose are being connected. Note: These are not rotating joints. They are for assembly benefits... Not as a constant rotation connection.



MINIMATIC® FITTINGS

CROSS FITTINGS

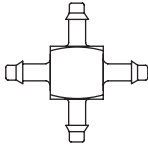
	Part No.	Barb	Material	
	Barb-to-Barb	X22-202	1/16"	ENP Brass
	X44-202	1/16 - 1/8 - 1/16 - 1/8"	ENP Brass	
	X44-402	1/16 - 1/8 - 1/8 - 1/8"	ENP Brass	
	X33-202	3/32 - 1/16 - 3/32 - 1/16"	ENP Brass	
	X33-303	3/32"	ENP Brass	
	X44-303	3/32 - 1/8 - 3/32 - 1/8"	ENP Brass	
	X44-404	1/8"	ENP Brass	

L, T, X FITTINGS

	Part No.	Porting	Material	
	#10-32 "X" Coupling	15002-5	X	Brass
	#10-32 to #10-32 Fittings	15002-2	L	Brass
		15002-3	T	Brass
		15002-4	X	Brass
	Adjustable #10-32 "L" Fitting	15002-1	L	Brass and Stainless Steel
	Adjustable #10-32 "T" Fitting	15002-6	T	Brass and Stainless Steel
	Miniature #10-32 Manifold Stud	12292	-	Stainless Steel
	1/8" NPT to #10-32 Adapter Fittings	15090-1	L	Brass
		15090-2	T	Brass
		15090-3	X	Brass







BULKHEAD FITTINGS

	Part No.	External Thd.	Internal Thd.
	Bulkhead Fittings	15027	#15/32-32 #10-32
	15029-1	3/4-20	1/8" NPT
	15029-2	3/4-20	1/4" NPT



#10-32 THREAD SCREW PLUGS

Part No.	Material
11755	Brass
11755-ENP	ENP Brass
11782-7-ENP	ENP Brass
0035-2	Captivated O-Ring Stainless Steel

#10-32 NIPPLES & COUPLINGS

	Part No.	Material	
	#10-32 Male Nipple	15453	Stainless Steel
	#10-32 Male Nipple	11999	Brass
	#10-32 Female Hex Coupling	15004	Brass
	#10-32 Extension Fitting	15010	Brass
	#10-32 Swivel Fitting	15040	Brass
	1/8" NPT Male to #10-32 Swivel Adapter	15060	Brass
	1/8" NPT Female to #10-32 Swivel Adapter	15050	Brass

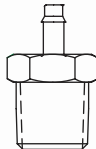
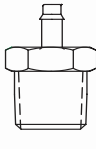
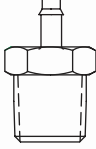
NPT TO BARB CONNECTORS

	Part No.	Thread	Material
	1/16" Barb to Male NPT	1CJ2	1/16" Brass
		2CP2	1/8" Brass
		4CQ2	1/4" Brass
	3/32" Barb to Male NPT	1CJ3	1/16" Brass
		2CP3	1/8" Brass
		4CQ3	1/4" Brass
	1/8" Barb to Male NPT	1CJ4	1/16" Brass
		2CP4	1/8" Brass
		4CQ4	1/4" Brass
	1/8" Barb to 1/8" Male NPT	11924-1	1/8" Brass

All barbs are noted in I.D.

PUSH-QUICK FITTINGS













STAINLESS STEEL

Constructed of high grade 316 stainless steel, these durable fittings provide a simple push-pull method of connecting pneumatic components to each other and system piping. Push-Quick fittings allow full flow through the hose/tubing I.D. with no smaller orifice required as in barb fittings. They are designed for use with both flexible hose and stiff tubing made of nylon, polyurethane, polyethylene or polypropylene. Many styles and sizes are available.

For more information, visit clippard.com/link/ss-pq

Medium	Air, inert gas, water, liquid, or oil
Pressure Range	0 to 250 psig @ 75°F
Vacuum	0 to 29.5" Hg
Tube Pull-Out Force @ 75° (non-pressurized)	1/8" - 5/32": >10 lb.; 1/4" - 1/2": >20 lb.
Temperature Range	5 to 230°F
Materials	316 stainless steel, FKM seals

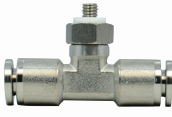
- Provides high corrosion and chemical resistance
- FDA approval for use in food environments
- Ideal for high temperature applications
- Small, compact design
- Complete selection of hose and tubing available online at clippard.com

Threaded Fittings		Non-Threaded Fittings	
Female Connectors PQS-FC		Straight Unions PQS-SU	
Male Connectors PQS-MC		Reduced Unions PQS-RU	
Bulkhead Connectors PQS-BC		Elbow Unions PQS-EU	
Male Elbows PQS-ME		Tee Unions PQS-TU	
Run Tees PQS-RT		Bulkhead Unions PQS-BU	
Branch Tees PQS-BT		Stem Couplers PQS-SC	

ORDERING INFORMATION

Base Part No.

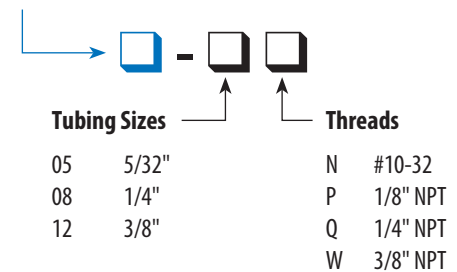

*See clippard.com/link/ss-pq for specific part numbers and ordering information



PUSH-QUICK FITTINGS

PLASTIC RESIN

Push-quick fittings provide a simple method of connecting pneumatic components to each other and system piping. They provide higher flows than barbed fittings and are designed for use with flexible hose or stiff tubing made of nylon, urethane, polyethylene or polypropylene. The 5/32" fittings may be used with 4 mm O.D. tubing.

For more information, visit clippard.com/link/pq

Pressure Range	0 - 150 psig @ 130°F
Vacuum	0 to 29.5" Hg
Temperature Range	32 to 140°F
Media	Air or non-corrosive water
Tube Pull Out Force	1/8" - 5/32": >10 lb.; 1/4" - 1/2": >20 lb. @ 75° (non pressurized)

ORDERING INFORMATION

Base Part No.



Tubing Sizes		Threads	
04	1/8"	N	#10-32
04M	4 mm	5	M5
05	5/32"	6	M6
06M	6 mm	P	1/8" NPT
08	1/4"	R	R1/8
08M	8 mm	Q	1/4" NPT
10	5/16"	2	R1/4
12	3/8"	W	3/8"
16	1/2"	3	R3/8
		Z	1/2" NPT

Plastic Plugs

May be used to plug a push-quick fitting port for later use

Part No.	Description
PQ-PG04	1/8" O.D. Tube
PQ-PG05	5/32" O.D. Tube
PQ-PG06M	6 mm O.D. Tube
PQ-PG08	1/4" O.D. Tube
PQ-PG10	5/16" O.D. Tube
PQ-PG12	3/8" O.D. Tube

Threaded Fittings		Non-Threaded Fittings	
Female Connectors PQ-FC		Straight Unions PQ-SU	
Male Connectors PQ-MC		Reduced Unions PQ-RU	
Male Compact Connectors PQ-CC		Elbow Unions PQ-EU	
Bulkhead Connectors PQ-BC		Tee Unions PQ-TU	
Male Angle Connectors PQ-MA		Y Unions PQ-YU	
Y Connectors PQ-YC		Cross Unions PQ-CU	
Female Elbows PQ-FE		Manifold Unions PQ-MU	
Male Elbows PQ-ME		Bulkhead Unions PQ-BU	
Extended Elbows PQ-EE		Reduced Branches PQ-RB	
Universal Elbows PQ-UE		Elbow Reducers PQ-ER	
Stack Elbows PQ-SE		Tube Reducers PQ-TR	
Run Tees PQ-RT		Plug-In Elbows PQ-PE	
Branch Tees PQ-BT		Tee Reducers PQ-TR	
Manifold Mounts PQ-MM		Stem Reducers PQ-SR	
		Stem Couplers PQ-SC	

ACCESSORIES

MINIATURE TERMINAL BLOCKS



Part No.	# of Ports
15028-4	4
15028-6	6
15028-8	8
15028-10	10



QUICK CONNECTS

Medium Air, Oil & Water
Seals Nitrile
Pressure Range 0 to 300 psig
Air Flow 85 l/min @ 50 psig;
 160 l/min @ 100 psig

MQC-2S

Part No.	Description
MQC-2S	QC Assembly, 1/8" Barb to #10-32 Male
MQC-3A	QC Assembly, 1/8" Barb to #10-32 Female
MQC-V2	Valve Body, #10-32 Male
MQC-V3	Valve Body, #10-32 Female Thread
MQC-VP	Valve Body, 1/8-27 NPT
MQC-FS	Hose Connector, 1/8" Barb
MQC-F2S	Hose Connector, 1/16" Barb
MQC-FT	Hose Connector, #10-32 Female Thread

FITTINGS KITS

For the ultimate in convenience, have a selection of helpful fittings available for every need. Keeping a supply on hand can save money and time, allowing projects, prototypes, circuits and repairs to be finished quickly and avoiding delays. Comes with plastic case.



Part No.	Description	Material
17555-SF1	Barb Fittings Kit	ENP Brass
17555	Minimatic® Fittings Kit	Brass

BRASS MUFFLERS



Part No.	Description
15080	1/8" NPT Brass Muffler
15070	#10-32 ENP Brass Muffler



Part No.	Ext. Thread
11130-N	#10-32
11130-P	1/8" NPT
11130-Q	1/4" NPT
11130-W	3/8" NPT
11130-Z	1/2" NPT

MANIFOLDS



Part No.	Description
MAN-12	12-Port Brass
MRM-6	6-Port Rotary

HOSE CLAMPS



Part No.	Material
5000-4	Brass <i>Use with VYH1-0804 hose</i>
5000-2	Zinc-Plated Steel

PIPE REDUCERS

	Part No.	External Thd.	Internal Thd.
	1CJF	1/16" NPT	#10-32
	2CPF	1/8" NPT	#10-32
	4CQF	1/4" NPT	#10-32
	2CPK	1/8" NPT	1/16" NPT
	4CQK	1/4" NPT	1/16" NPT
	4CQN	1/4" NPT	1/8" NPT
	15036	1/8" NPT	#10-32

Will adapt standard pipe to fittings and Clippard miniature components. (-ENP) optional.

COMPRESSION FITTINGS

	Part No.	Tube (O.D.)	Material
	11923	1/8"	Brass
	15160	1/16"	Brass
	3810-1	1/8"	Brass
	3810-2	1/16"	Brass







GASKETS

Designed for use with #10-32 threads

	Material	Part No.	O.D.	I.D.
	Nitrile	11761-2	0.240	0.150
	FKM	11761-8	0.240	0.150
	Nylon	11761-4	0.307	0.192
	EPDM	11761-7	0.240	0.150

HOSE & TUBING

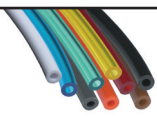
Polyurethane tubing offers a wider range of chemical compatibility than vinyl, may be used at much higher temperatures, and does not require clamps when used with barb fittings. When using hose or tubing, care should always be taken to avoid sharp bends to prevent compressing the inside diameter of the hose or tubing and restricting flow. For extremely close connections, allow a short loop of hose to avoid crimping.

Type	O.D.	I.D.	Bend Radius	Working Range	Part No.	Colors	50' Roll	500' Roll
 Ether Based 95A Durometer Polyurethane	5/32"	3/32"	3/8"	0 to 105 psig @ 100°F (max. 120°F)	URT1-0503-□□	● - BKS ✨ - CLT ✨ - BLT ✨ - GNT ✨ - RDT ✨ - YLT	-050	-500
	1/4"	0.160"	1/2"		URT1-0805-□□	● - BKS ✨ - CLT ✨ - BLT ✨ - GNT ✨ - RDT	-050	-500
	3/8"	1/4"	7/8"		URT1-1208-□□	● - BKS ✨ - CLT ✨ - BLT ✨ - GNT ✨ - RDT	-050	-500
 Medical/Laboratory Grade Silicone	0.065"	0.030"	–	0 to 30 psig	SIH1-0201-NAS-□	Clear	-005	-500
	3/32"	1/32"	–		SIH1-0301-NAS-□		-005	-500
	1/8"	1/16"	–		SIH1-0402-NAS-□		-005	-500
	3/16"	1/16"	–		SIH1-0602-NAS-□		-005	-500
	1/4"	1/8"	–	SIH1-0804-NAS-□	-005		-500	
	5/16"	3/16"	–	SIH1-1006-NAS-□	-005		-500	
	3/8"	1/4"	–	SIH1-1208-NAS-□	-005		-500	
 Sanitary Food Grade Silicone	1/8"	1/16"	1/4"	0 to 14 psig	SFG1-0402-NAS-□	Clear	-005	-500
	1/4"	1/8"	1/4"		SFG1-0804-NAS-□		-005	-500
	3/8"	1/4"	3/4"	0 to 9 psig	SFG1-1208-NAS-□		-005	-500
 80A Durometer Vinyl	1/8"	1/16"	3/8"	0 to 105 psig @ 70°F (max. 60 psig @ 80° to 100°F)	VYH1-0402-CLT-□	Clear	-050	-500
	1/4"	1/8"	3/4"		VYH1-0804-CLT-□		-050	-500
 85A Durometer Polyurethane	1/8"	1/16"	3/16"	0 to 105 psig @ 100°F (max. 120°F)	URH1-0402-□□	● - BKS ● - BRS ✨ - CLT ✨ - BLT ✨ - GNT ✨ - RDT ✨ - YLT	-050	-500
	1/4"	1/8"	3/8"		URH1-0804-□□		-050	-500
 85A Durometer Polyurethane Ribbon	1/8"	1/16"	3/16"	0 to 105 psig @ 100°F (max. 120°F)	URH8-0402-02T-050	All (ribbon)	-050	—
	1/4"	1/8"	3/8"		URH8-0804-02T-050		-050	—
 85A Durometer Twin Molded Polyurethane	1/4"	1/8"	3/8"	0 to 105 psig @ 100°F (max. 120°F)	URH2-0804-01S-□	Black & gray	-050	-500

To order, add color selection and roll length to the end of the number. **Example:** URT1-0503-BLT-050

Color Key Solid: ● Black (BKS) ● Brown (BRS)

Translucent: ✨ Blue (BLT) ✨ Clear (CLT) ✨ Green (GNT) ✨ Red (RDT) ✨ Yellow (YLT)

This Page Intentionally Left Empty

INDEX

#

1022, 1030.....p. 128
2010, 2011, 2012.....p. 96
2013, 2020, 2021.....p. 97
3810.....p. 185
5000.....p. 188
11130.....p. 188
11749.....p. 184
11750, 11752.....p. 182
11755.....p. 185
11761, 11782, 11792.....p. 182
11916.....p. 90
11923, 11924.....p. 185
11925.....p. 90
11999, 12292.....p. 184
12296.....p. 90
1935-2.....p. 185
12841-12845.....p. 182
15002, 15004, 15010.....p. 184
15027-15029.....p. 185
15036.....p. 185
15040.....p. 184
15045.....p. 182
15050.....p. 184
15055.....p. 182
15060.....p. 184
15070.....p. 188
15080.....p. 188
15090.....p. 184
15160.....p. 185
15453.....p. 184
17555.....p. 188
27021-27025.....p. 177
27050-27055.....p. 177
27057, 27059, 27070.....p. 177
3849-1.....p. 177
9002-01.....p. 177
10 & 15 mm Valves.....p. 39
10 & 15 mm Valves, Accessories.....p. 44
10 & 15 mm Valves, Manifolds.....p. 44
10 mm Valves.....pp. 40-41
10 mm Valves, Hit & Hold Circuits.....p. 38
12-Port Brass Manifold.....p. 188
15 mm Valves.....pp. 42-43
15 mm Valves, Hit & Hold Circuits.....p. 38
1CJ2-1CJ4.....p. 185
1CF.....p. 185
2013 Overvoltage Coil Ratings.....p. 27
2CP2-2CP4.....p. 185
2CPF, 2CPK, 2CQK.....p. 185
3200-A.....p. 97
3BDD, 3BDS.....p. 161
3CD, 3CS, 3PS, 3SD, 3SS, 3SS-AR.....p. 161
4CQ2-4CQ4, 4CQF, 4CQN.....p. 185
6-Port Rotary Manifold.....p. 188
6CW.....p. 185
7 mm Valves.....p. 29

7 mm Valves, Hit & Hold Circuits.....p. 38
7D, 7DD, 7SD, 7SS, 7SS-AR.....p. 162
8 mm Valves.....p. 30
8 mm Valves, Hit & Hold Circuits.....p. 38
80A & 85A Durometer Tubing.....p. 189
8CZ.....p. 185
95A Durometer Tubing.....p. 189
9BDD, 9BDS, 9BS.....p. 161
9CD, 9CS.....p. 161
9PS.....p. 161
9SD, 9SS.....p. 161
9SS-AR.....p. 162

A

Actuator Arms.....p. 89
Actuators.....pp. 90-92
Actuators, Push Button.....p. 91
Air Chokes.....p. 121
Air Indicators.....p. 128
Air Pilot Valves.....p. 96
Air Pilot Valves, 2-Way.....p. 74
Air Pilot Valves, 3-Way.....p. 76
Air Preparation Equipment.....pp. 168-179
Air Volume Tanks.....p. 163
All Stainless Steel Cylinders.....pp. 148-151
All Stainless Steel Cylinders, Accessories...p. 164
Amplifier Valves.....p. 96
Analytical Service.....p. 8
AR.....p. 89
Auto-Cycling Module.....pp. 106, 107, 110
AVT.....p. 163
AVT-PP.....p. 163

B

Back Pressure Latch Control.....p. 109
Back-Pressure Sensing Module...pp. 107, 110
Barb Connectors.....p. 182
Barb Fittings Kit.....p. 188
BFC Series.....p. 120
BHH2.....p. 188
BHH4.....p. 188
Binary Redirect Module.....p. 106
Bleed Pressure Piloted Limit Valves...p. 96
Block Manifolds.....p. 188
BNM Series.....p. 120
BNV Series.....p. 120
Branch Tee Fittings.....p. 183
Brass Cylinder Accessories.....p. 165
Brass Cylinders.....pp. 160-163
Brass Mufflers.....p. 188
BTT.....p. 188
Bulkhead Fittings.....p. 184

C

C22, C32, C33, C43, C44.....p. 182
Captivated Push Button Actuators.....p. 91
CBR-24.....p. 145

CDR-24.....p. 144
CF0.....p. 183
CF2-CF4.....p. 182
CFR-24.....p. 145
Check Valves.....p. 116
Chemical Compatibility Chart.....p. 65
Cleaning Capabilities.....pp. 8-9
Compact Extruded Cylinders.....pp. 156-159
Compact Extruded Cylinders,
Accessories...p. 165
Compression Fittings.....p. 184
Corrosion-Resistant Cylinders...pp. 152-155
Corrosion-Resistant Cylinders,
Accessories.....p. 165
Couplings.....p. 184
CPS-C8Q5.....p. 166
CQ2-ADD-12, CQ2-ADD-16.....p. 158
CQ2-ADD-20, CQ2-ADD-25.....p. 158
CQ2-ADD-32, CQ2-ADD-40.....p. 159
CQ2-ADD-50.....p. 159
CQ2-ADR-12, CQ2-ADR-16.....p. 158
CQ2-ADR-20, CQ2-ADR-25.....p. 158
CQ2-ADR-32, CQ2-ADR-40.....p. 159
CQ2-ADR-50.....p. 159
CQ2-ARR-12, CQ2-ARR-16.....p. 158
CQ2-ARR-20, CQ2-ARR-25.....p. 158
CQ2-ARR-32, CQ2-ARR-40.....p. 159
CQ2-ARR-50.....p. 159
CQ2-ASR-12, CQ2-ASR-16.....p. 158
CQ2-ASR-20, CQ2-ASR-25.....p. 158
CQ2-ASR-32, CQ2-ASR-40.....p. 159
CQ2-ASR-50.....p. 159
CQ2-BDD-12, CQ2-BDD-16.....p. 158
CQ2-BDD-20, CQ2-BDD-25.....p. 158
CQ2-BDD-32, CQ2-BDD-40.....p. 159
CQ2-BDD-50.....p. 159
CQ2-BDR-12, CQ2-BDR-16.....p. 158
CQ2-BDR-20, CQ2-BDR-25.....p. 158
CQ2-BDR-32, CQ2-BDR-40.....p. 159
CQ2-BDR-50.....p. 159
CQ2-BRR-12, CQ2-BRR-16.....p. 158
CQ2-BRR-20, CQ2-BRR-25.....p. 158
CQ2-BRR-32, CQ2-BRR-40.....p. 159
CQ2-BRR-50.....p. 159
CQ2-BSR-12, CQ2-BSR-16.....p. 158
CQ2-BSR-20, CQ2-BSR-25.....p. 158
CQ2-BSR-32, CQ2-BSR-40.....p. 159
CQ2-BSR-50.....p. 159
CR-SDD-10, CR-SDD-12, CR-SDD-17...p. 154
CR-SDD-20, CR-SDD-24.....p. 155
CR-SDR-10, CR-SDR-12, CR-SDR-17...p. 154
CR-SDR-20, CR-SDR-24.....p. 155
CR-UDR-10, CR-UDR-12, CR-UDR-17...p. 154
CR-UDR-20, CR-UDR-24.....p. 155
Cross Fittings.....p. 184
CRR-24, CSN-24, CSR-24.....p. 144
CT0.....p. 183
CT2-CT4.....p. 182
Cushions.....p. 134

Custom Solutions.....p. 12
Cylinders.....pp. 130-167
Cylinders, Accessories.....pp. 164-165
Cylinders, All Stainless Steel...pp. 148-151
Cylinders, Brass.....pp. 160-163
Cylinders, Compact Extruded...pp. 156-159
Cylinders, Corrosion-Resistant...pp. 152-155
Cylinders, Cushions.....p. 134
Cylinders, Force Factors.....p. 135
Cylinders, Interchange Guide.....p. 133
Cylinders, Maximum Load.....p. 135
Cylinders, Options Available.....p. 132
Cylinders, Rod Types.....p. 133
Cylinders, Spring Forces.....p. 135
Cylinders, Stainless Steel.....pp. 136-147
Cylinders, Types.....p. 133

D

DR-1 Series.....p. 124
DR-2 Series.....p. 125
DV Series.....pp. 32-34
DV Series, Hit & Hold Circuits.....p. 38
DV Series, Overvoltage Coil Ratings.....p. 27
DVP Series.....pp. 58-59

E

E10HM, E10LM.....p. 40
E210A, E210C.....p. 41
E210H.....p. 40
E215D, E215E, E215F.....p. 43
E215H.....p. 42
E2L10C.....p. 40
E2L15E, E2L15F.....p. 42
E3010A, E3010C.....p. 41
E3015E, E3015F.....p. 43
E310A, E310C.....p. 41
E311E.....p. 40
E315D, E315E, E315F.....p. 43
E3L10C.....p. 40
E3L15E, E3L15F.....p. 42
EBR-24.....p. 145
EC-2.....p. 14
EC-3.....p. 16
EC-P.....p. 56
ECN.....p. 18
ECO-3.....p. 17
ECR-2.....p. 15
EDR-24.....p. 144
EFB Series.....p. 36
EFR-24.....p. 145
EI/EIO Series.....p. 19
Elbow Barb Fittings.....p. 183
Electronic Manifold Cards.....p. 21
Electronically Piloted Valves.....p. 97
EM Series.....p. 22
EM Series Hit & Hold Circuits.....p. 38

INDEX

ERR-24..... p. 144
ES Series Hit & Hold Circuits..... p. 28
ES-1..... p. 129
ES/ESO Series..... pp. 23-26
ESN-24, ESR-24..... p. 144
ET-2..... p. 14
ET-3..... p. 16
ET-P..... p. 56
ETN..... p. 18
ETO-3..... p. 17
ETR-2..... p. 15
EV Series..... pp. 4, 5, 10
EV Series, Hit & Hold Circuits..... p. 38
EV Series, Flow Chart..... p. 13
EV-2..... p. 14
EV-P..... p. 56
EV, ET Overvoltage Coil Ratings..... p. 27
EVN..... p. 18
EVO-3..... p. 17
EVP Series..... pp. 54-57
EVP Series, Flow Chart..... p. 55
EVPD Driver..... p. 57
EW-2..... p. 14
EW-3..... p. 16
EWO-3..... p. 17
EWR-2..... p. 15
Exhaust Valves..... p. 117

F

FBV Series..... p. 80
FDR-08..... p. 138
FDR-10, FDR-12..... p. 140
FDR-17..... p. 142
FDR-24..... p. 144
Fill & Bleed Circuit..... p. 36
Fill & Bleed Toggle Valves..... p. 80
Filter-Regulator-Lubricator Units..... p. 172
Filters..... p. 175
Fittings & Tubing..... pp. 180-189
Fittings Kits..... p. 188
Flip-Flop Circuit..... p. 106
Flow Controls..... pp. 118-120
Food Grade Tubing..... p. 189
Foot Pedal Valves..... p. 93
Force Factors..... p. 135
FRLs..... p. 172
FRR-24..... p. 144
FSR-08..... p. 138
FSR-10, FSR-12..... p. 140
FSR-17..... p. 142
FSR-24..... p. 144
FTV Series..... p. 82
FV Series..... p. 86

G

Gap Sensor..... p. 128
Gauges..... p. 121

GCV Series..... p. 116
GMR Sensors..... pp. 166-167
GNV Series..... p. 123
GPS..... pp. 166-167
Gradient Mixing Valves..... p. 69
GV Series..... p. 88

H

H9C, H9D, H9S, H9U..... p. 162
Heavy Duty Limit Valves..... p. 89
Heavy-Duty Actuators..... p. 91
Hit & Hold Circuits..... p. 38
Hose & Tubing..... p. 189
Hose Clamps..... p. 188
HTV Series..... p. 83
HV Series..... p. 85
Hysteresis..... p. 63

I

In-Line Fixed Orifice Air Chokes..... p. 121
In-Line Volume Chamber..... p. 121
IND..... p. 128
Interchange Guide..... p. 133
Intrinsically Safe Series..... p. 19

J

JEV Series..... p. 117
JFC Series..... p. 118
JLEV Series..... p. 117
JPC Series..... p. 116
JSLV..... p. 89
JSV Series..... p. 127

L

L Fittings..... p. 184
Laboratory Grade Tubing..... p. 189
Leak Detection..... p. 28
Lever Valves..... p. 93
Limit Valves..... p. 89
Low Pressure Air Pilot Valves..... pp. 96-97
Lubricators..... p. 176
LVA/LVA0..... p. 89

M

MAC..... p. 121
Manifold, 12-Port Brass..... p. 188
Manifold, 6-Port Rotary..... p. 188
Manually-Operated Valves..... p. 93
MAR-1 Series..... p. 126
MAS..... p. 129
MAT..... p. 121
Material Properties Chart..... p. 65
MAV/MAVO Series..... p. 85
Maximatic Air Pilot Valves..... pp. 99-101
Maximatic Air Pilot Valves,
Manifolds..... p. 101

Maximatic FRLs..... pp. 170-173
Maximatic FRLs, Accessories..... p. 178-179
Maximatic FRLs, L & T Brackets..... p. 179
Maximatic FRLs, Mounting Hardware..... p. 178
Maximatic FRLs, Replacement Parts..... p. 177
Maximatic FRLs, Spacers..... pp. 178-179
Maximatic Series, Accessories..... p. 51
Maximatic Series, Manifolds..... p. 51
Maximatic Series Valves..... pp. 46-48
Maximum Load by Rod Length..... p. 135
MBA..... p. 90
MCV Series..... p. 116
Media Isolation Valves..... p. 68
Medical Grade Tubing..... p. 189
MEV Series..... p. 117
MFC Series..... p. 118
Miniature Block Terminals..... p. 188
Minimatic Fittings..... pp. 182-185
Minimatic Fittings Kit..... p. 188
Minimatic Fittings, Barb Connectors..... p. 182
Minimatic Fittings, Branch Tees..... p. 183
Minimatic Fittings, Bulkhead Fittings..... p. 184
Minimatic Fittings, Compression Fittings..... p. 184
Minimatic Fittings, Couplings..... p. 184
Minimatic Fittings, Cross..... p. 184
Minimatic Fittings, Elbow Barb..... p. 183
Minimatic Fittings, L..... p. 184
Minimatic Fittings, Nipples..... p. 184
Minimatic Fittings,
NPT to Barb Connectors..... p. 184
Minimatic Fittings, Pipe Reducers..... p. 184
Minimatic Fittings, Run Tees..... p. 184
Minimatic Fittings, Screw Plugs..... p. 184
Minimatic Fittings, T..... p. 184
Minimatic Fittings, X..... p. 184
MJC..... p. 116
MJTV Series..... p. 83
MJV/MJVO Series..... p. 87
MMA..... p. 100
MME-2..... p. 49
MME-3..... p. 49
MME-4..... p. 50
MMF..... p. 175
MMFRL..... p. 172
MMFRLS..... p. 173
MMFRS..... p. 174
MMH..... pp. 178-179
MML..... p. 176
MMR..... p. 176
MMSV..... p. 177
MMV..... p. 93
MNV Series..... p. 122
Modular Valves..... pp. 102-113
Modular Valves, Actuation Options..... p. 102
Modular Valves, Mounting Plates..... p. 105
Modular Valves, Octoport Coding..... p. 103
Modular Valves,
Standard Circuits..... pp. 104, 106-110
Mouse Valves..... pp. 6-7

Mouse Valves, Manifolds..... p. 20
MPA..... p. 90
MQC..... p. 188
MSV Series..... p. 127
MTV Series..... p. 81
Muffler, Polyethylene..... p. 177
Mufflers..... p. 121
Mufflers, Brass..... p. 188
Multi-Pin Air Indicator..... p. 128
MWV-1..... p. 128

N

Needle Valves..... pp. 122-123
Nipple with Micron Filter..... p. 177
Nipples..... p. 184
NIV Series..... pp. 68-69
Non-Contact Gap Sensor..... p. 128
Non-Contact Proximity Sensor..... p. 128
NPP Series Pneumatic Pinch Valves..... p. 71
NPT to Barb Connectors..... p. 184
NPV Series Electronic Pinch Valves..... p. 70
NR..... pp. 68-69

O

Oscillator Module..... p. 106
Oxygen Service..... p. 9

P

P22..... p. 92
Palm Button Valves..... p. 93
PAV/PAVO Series..... p. 98
PB..... p. 93
PC..... p. 91
PG..... p. 121
Pilot-Operated Check Valves..... p. 116
Pinch Valve Tubing..... p. 189
Pinch Valves..... pp. 70-71
Pipe Reducers..... p. 184
PL..... p. 92
Plastic Resin Push-Quick Fittings..... p. 187
Polyurethane Tubing..... p. 189
Position Sensors..... pp. 166-167
PQ..... p. 187
PQ-CI, PQ-CV, PQ-FV..... p. 119
PQS..... p. 186
Pressure Actuated Switches..... p. 129
Pressure Piloted Valves..... p. 97
Pressure Regulators..... pp. 124-126
Proportional Isolation Valve..... p. 62
Proximity Sensor..... p. 128
Pulse Valves..... p. 128
Push Button Actuators..... p. 91
Push-Quick Fittings..... pp. 186-187
Push-Quick Flow Controls..... p. 119
Push/Pull Spool Valves..... p. 93
PV-1..... p. 128

INDEX

Q

Quick Connects..... p. 188
Quick-Connect Fittings Kit..... p. 188

R

R-301, R-302, R-305..... p. 111
R-310-R-315, R-321-R-324..... p. 111
R-331-R-334, R-341, R-343..... p. 111
R-351-R-353, R-355,..... p. 112
R-401, R-402..... p. 112
R-410, R-412, R-421..... p. 113
R-431-R-434..... p. 112
R-441-R-443, R-445..... p. 113
R-451, R-453, R-454..... p. 113
R-461, R-462, R-465..... p. 113
R-471, R-472, R-481, R-482..... p. 113
R-501, R-502, R-602, R-603..... p. 113
R-711..... p. 113
R-801, R-811, R-821, R-932..... p. 113
Reed Switches..... pp. 166-167
Regulators..... p. 176
Ribbon Tubing..... p. 189
RPS..... pp. 166-167
Run Tees..... p. 184

S

S33, S3F..... p. 182
S40..... p. 183
S42..... p. 185
S44..... p. 182
S44..... p. 185
S4F..... p. 182
S4N..... p. 182
SAS..... p. 129
SBR-12..... p. 141
SBR-17..... p. 142
SBR-20..... p. 143
SBR-24..... p. 145
SBR-32..... p. 146
SCM..... p. 121
SCPV Series..... pp. 60-61
SCPVD Driver..... p. 61
Screw Plugs..... p. 184
SDD-08..... p. 138
SDD-09..... p. 139
SDD-10, SDD-12..... p. 140
SDD-14..... p. 141
SDD-17..... p. 142
SDD-20..... p. 143
SDD-24..... p. 144
SDD-28..... p. 145
SDD-32..... p. 146
SDD-40, SDD-48..... p. 147
SDH-12, SDH-14..... p. 141
SDH-17..... p. 142
SDR-05, SDR-08..... p. 138

SDR-09..... p. 139
SDR-10, SDR-12..... p. 140
SDR-14..... p. 141
SDR-17..... p. 142
SDR-20..... p. 143
SDR-24..... p. 144
SDR-28..... p. 145
SDR-32..... p. 146
SDR-40, SDR-48..... p. 147
Sensors..... p. 128
SFD-12..... p. 141
SFD-17..... p. 142
SFD-24..... p. 145
SFR-12..... p. 141
SFR-17..... p. 142
SFR-20..... p. 143
SFR-24..... p. 145
SFR-32..... p. 146
Shut-Off/Lock-Out Valves..... p. 177
Shuttle Valves..... p. 127
Silicone Tubing..... p. 189
Single Input Clamp Control Module... p. 107
Single Pole Electrical Switch..... p. 129
Sleeve Valves..... p. 89
SLV..... p. 89
SM-2, SM-3, SM-6..... p. 161
SMAV Series..... p. 78
SMTV Series..... p. 78
Solenoid Valve Overvoltage..... p. 27
SP0..... p. 183
SP2-SP4..... p. 185
Special Cleaning Requirements..... p. 9
Special Materials..... pp. 64-65
Speed Control Mufflers..... p. 121
Spring Forces..... p. 135
SRR-05..... p. 138
SRR-08..... p. 138
SRR-09..... p. 139
SRR-10..... p. 140
SRR-12, SRR-14..... p. 141
SRR-17..... p. 142
SRR-20..... p. 143
SRR-24, SRR-28..... p. 145
SRR-32..... p. 146
SS-AVT..... p. 163
SS-CDR-24, SS-EDR-24..... p. 151
SS-SDD-17..... p. 150
SS-SDD-24, SS-SDD-32..... p. 151
SS-SDR-12, SS-SDR-17..... p. 150
SS-SDR-24, SS-SDR-32..... p. 151
SS-UDD-12, SS-UDR-12, SS-UDR-17... p. 150
SS-UDR-32..... p. 151
SSN-08..... p. 138
SSN-09..... p. 139
SSN-10, SSN-12..... p. 140
SSN-14..... p. 141
SSN-17..... p. 142
SSN-20..... p. 143
SSN-24..... p. 144

SSN-28..... p. 145
SSR-05, SSR-08..... p. 138
SSR-09..... p. 139
SSR-10, SSR-12..... p. 140
SSR-14..... p. 141
SSR-17..... p. 142
SSR-20..... p. 143
SSR-24..... p. 144
SSR-28..... p. 145
SSR-32..... p. 146
ST Series..... p. 30
ST Series Hit & Hold Circuits..... p. 38
STO..... p. 183
ST3, ST4..... p. 182
Stainless Steel Cylinders..... pp. 136-147
Stainless Steel Cylinders, Accessories... p. 164
Stainless Steel Push-Quick Fittings... p. 186
Stem Valves, 2-Way..... p. 74
Stem Valves, 3-Way..... p. 76
Stem Valves, 4-Way..... p. 77
SV Series..... p. 29
SV Series Hit & Hold Circuits..... p. 38
Switches..... p. 129

T

T Fittings..... p. 184
T22, T33, T42, T44..... p. 183
TDR-12..... p. 140
TDR-17..... p. 142
TDR-24..... p. 144
THNTD Circuit..... pp. 108, 109
Toggle Valves, 2-Way..... p. 74
Toggle Valves, 3-Way..... p. 75
Toggle Valves, 4-Way..... p. 77
TSR-12..... p. 140
TSR-17..... p. 142
TSR-24..... p. 144
TTO..... p. 183
TT2-TT4..... p. 185
Tubing..... p. 189
TV Series..... p. 84
TV/TVO Series..... p. 79
Twin Molded Tubing..... p. 189
Two-Hand, No-Tie-Down Circuit... pp. 108, 109

U

UBR-12..... p. 141
UBR-17..... p. 142
UBR-20..... p. 143
UBR-32..... p. 146
UC-0848..... p. 166
UDR-05, UDR-08..... p. 138
UDR-09..... p. 139
UDR-10, UDR-12..... p. 140
UDR-14..... p. 141
UDR-17..... p. 142
UDR-20..... p. 143

UDR-28..... p. 145
UDR-32..... p. 146
UDR-40, UDR-48..... p. 147
UFR-12..... p. 141
UFR-17..... p. 142
UFR-20..... p. 143
UFR-32..... p. 146
URR-05, URR-08..... p. 138
URR-09..... p. 139
URR-10..... p. 140
URR-12, URR-14..... p. 141
URR-17..... p. 142
URR-20..... p. 143
URR-28..... p. 145
URR-32..... p. 146
USB-20..... p. 143
USN-08..... p. 138
USN-09..... p. 139
USN-10, USN-12..... p. 140
USN-14..... p. 141
USN-17..... p. 142
USN-28..... p. 145
USR-05, USR-08..... p. 138
USR-09..... p. 139
USR-10, USR-12..... p. 140
USR-14..... p. 141
USR-17..... p. 142
USR-20..... p. 143
USR-28..... p. 145
USR-32..... p. 146
UTO..... p. 183
UTF..... p. 184
UTF-F..... p. 185

V

VA-011..... p. 106
VA-023..... p. 108
VA-028..... p. 107
VA-03..... p. 106
VA-031..... p. 107
VA-033..... p. 110
VA-034..... p. 109
VA-038..... p. 109
VA-06..... p. 110
VA-08..... p. 107
VG..... p. 121
Vinyl Tubing..... p. 189
Volume Chambers..... p. 121

W

Water Drawback Valves..... p. 129
WDV-2..... p. 129
Whisker Valves..... p. 128

X

X Fittings..... p. 184
X2, X3, X4, XT..... p. 184

WORLDWIDE DISTRIBUTION

Clippard products are distributed through our worldwide network of sales and engineering specialists. All of our representatives are stocking distributors and keep a variety of Clippard products on hand to fill your immediate needs. Each of our distributors are backed by our own large inventory to ensure quick delivery.

To locate your nearest distributor, call **877-245-6247** or visit clippard.com/distributors



CORPORATE OFFICE

United States ISO 9001:2015
7390 Colerain Avenue
Cincinnati, OH 45239
877-245-6247



United States ISO 9001:2015
4141 Thunderbird Lane
Fairfield, OH 45014
877-245-6247
clippard.com



Belgium
Parc Scientifique Einstein; Rue du Bosquet
B-1348 Louvain-la-Neuve-Sud
32-10-45-21-34
clippard.eu



China
3-1107, No. 599 Jianzhu Road
Wuxi, Jiangsu
86-137-9527-9010
zh.clippard.com



LIMITED WARRANTY

Clippard Instrument Laboratory, Inc. (seller) warrants its products to be free from defects in material and workmanship for a period of one (1) year from the date of sale. Seller's liability shall be limited at seller's option to repair, replacement or refund of purchase price of product found by seller's examination to be defective. All claims under this warranty must be made in writing to seller's factory sales department giving full details, prior to return of product, postpaid, to factory. Seller shall not be responsible for product failure due to normal wear, accident, buyer's misapplication, abuse, neglect or alteration of product. Seller will not be responsible for any consequential damages. Clippard Instrument Laboratory, Inc. makes no other warranty of any kind, expressed or implied. Circuits shown in this catalog are for instructional purposes only. All circuits and components used on equipment and machinery should be thoroughly tested by qualified personnel under actual working conditions to determine their suitability for buyer's intended use. All technical data and operations are average values based on standard production models. Some deviations can be expected and considerations should be given during initial design stages. All operating characteristics are based on new equipment, under normal conditions of use and environments and oil free air supply. Dimensions stated may be nominal and are subject to change without notice. Contact Clippard for specific dimensional tolerances when dimensions are critical. Clippard®, Maximatic®, and Minimatic® are registered trademarks of Clippard Instrument Laboratory, Inc.

CA PROPOSITION 65

All products shipped to or sold to consumers in California include Proposition 65 documentation with the shipment and reference our website. There are over nine hundred (900) chemicals on the Proposition 65 list, some of which are used in Clippard materials and/or processes. Although not all products contain chemicals within the list, Clippard is being cautious and diligent in complying with the California Law.

As of August 30, 2018, chemicals we are aware of that are listed within Proposition 65 are detailed online at clippard.com/link/prop65, or for additional information please contact tech@clippard.com.

DISTRIBUTED BY:

Clippard

7390 Colerain Avenue
Cincinnati, Ohio 45239
877-245-6247
clippard.com

MARKETS:

Aerospace
Agriculture
Analytical
Animatronics
Automation
Automotive
Dairy
Dental
Electronics
Food & Beverage
HVAC
Machinery
Medical
Mining
Packaging
Pharmaceutical
Printing
Process
Recreation
Semiconductor
Textile
Transportation

CILCAT-18

©2018 Clippard Instrument Laboratory, Inc. All Rights Reserved.